

24-Bit, 96 kHz Stereo DAC for Audio

Features

- Complete Stereo DAC System: Interpolation, D/A, Output Analog Filtering
- 101 dB Dynamic Range
- 91 dB THD+N
- Low Clock Jitter Sensitivity
- +3 V to +5 V Power Supply
- Filtered Line Level Outputs
- On-Chip Digital De-emphasis for 32, 44.1, and 48 kHz
- 30 mW with 3 V supply
- Popguard[®] Technology for Control of Clicks and Pops

Description

The CS4340 is a complete stereo digital-to-analog system including digital interpolation, fourth-order delta-sigma digital-to-analog conversion, digital de-emphasis and switched capacitor analog filtering. The advantages of this architecture include: ideal differential linearity, no distortion mechanisms due to resistor matching errors, no linearity drift over time and temperature and a high tolerance to clock jitter.

The CS4340 accepts data at audio sample rates from 2 kHz to 100 kHz, consumes very little power, and operates over a wide power supply range. The features of the CS4340 are ideal for DVD players, CD players, set-top box and automotive systems.

ORDERING INFORMATION

CS4340-KS	16-pin SOIC, -10 to 70 °C
CS4340-BS	16-pin SOIC, -40 to 85 °C
CDB4340	Evaluation Board

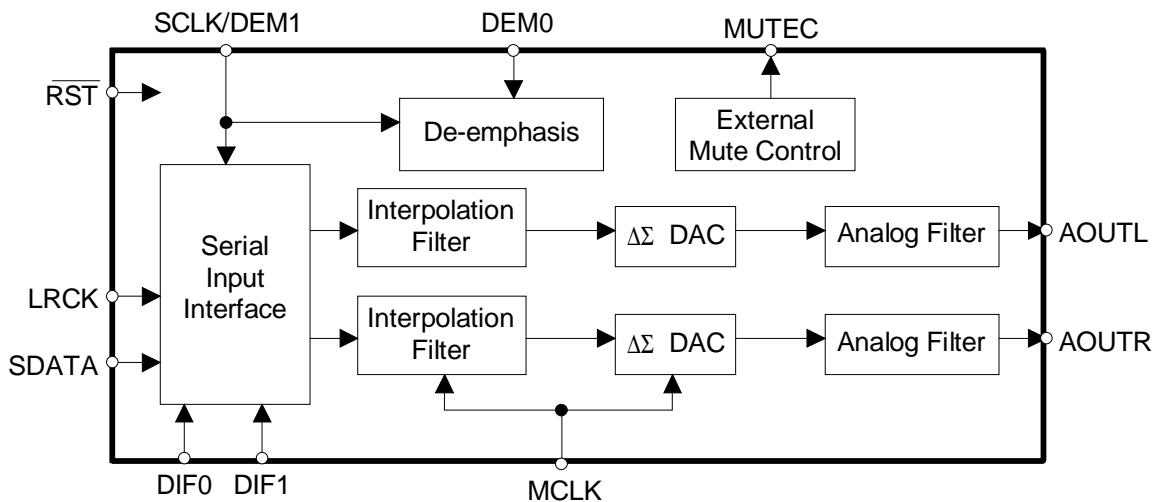

TABLE OF CONTENT

1. CHARACTERISTICS AND SPECIFICATIONS	5
ANALOG CHARACTERISTICS.....	5
ANALOG CHARACTERISTICS.....	6
ANALOG CHARACTERISTICS.....	7
POWER AND THERMAL CHARACTERISTICS	8
DIGITAL CHARACTERISTICS.....	8
RECOMMENDED OPERATING CONDITIONS	9
SWITCHING CHARACTERISTICS	10
2. TYPICAL CONNECTION DIAGRAM	12
3. PIN DESCRIPTION	13
4. APPLICATIONS	16
4.1 Grounding and Power Supply Decoupling	16
4.2 Oversampling Modes	16
4.3 Recommended Power-up Sequence	16
4.4 Popguard [®] Transient Control	16
5. INTERPOLATION FILTER RESPONSE PLOTS	17
6. DIGITAL INTERFACE FORMATS	19
7. ANALOG PERFORMANCE PLOTS	21
8. PARAMETER DEFINITIONS	26
Total Harmonic Distortion + Noise (THD+N)	26
Dynamic Range	26
Interchannel Isolation.....	26
Interchannel Gain Mismatch	26
Gain Error	26
Gain Drift.....	26
9. REFERENCES	26
10. PACKAGE DIMENSIONS	27

Contacting Cirrus Logic Support

For a complete listing of Direct Sales, Distributor, and Sales Representative contacts, visit the Cirrus Logic web site at:
<http://www.cirrus.com/corporate/contacts/>

Preliminary product information describes products which are in production, but for which full characterization data is not yet available. Advance product information describes products which are in development and subject to development changes. Cirrus Logic, Inc. has made best efforts to ensure that the information contained in this document is accurate and reliable. However, the information is subject to change without notice and is provided "AS IS" without warranty of any kind (express or implied). No responsibility is assumed by Cirrus Logic, Inc. for the use of this information, nor for infringements of patents or other rights of third parties. This document is the property of Cirrus Logic, Inc. and implies no license under patents, copyrights, trademarks, or trade secrets. No part of this publication may be copied, reproduced, stored in a retrieval system, or transmitted, in any form or by any means (electronic, mechanical, photographic, or otherwise) without the prior written consent of Cirrus Logic, Inc. Items from any Cirrus Logic website or disk may be printed for use by the user. However, no part of the printout or electronic files may be copied, reproduced, stored in a retrieval system, or transmitted, in any form or by any means (electronic, mechanical, photographic, or otherwise) without the prior written consent of Cirrus Logic, Inc. Furthermore, no part of this publication may be used as a basis for manufacture or sale of any items without the prior written consent of Cirrus Logic, Inc. The names of products of Cirrus Logic, Inc. or other vendors and suppliers appearing in this document may be trademarks or service marks of their respective owners which may be registered in some jurisdictions. A list of Cirrus Logic, Inc. trademarks and service marks can be found at <http://www.cirrus.com>.

LIST OF FIGURES

Figure 1. External Serial Mode Input Timing	11
Figure 2. Internal Serial Mode Input Timing	11
Figure 3. Internal Serial Clock Generation	11
Figure 4. Typical Connection Diagram	12
Figure 5. Base-Rate Stopband Rejection	17
Figure 6. Base-Rate Transition Band	17
Figure 7. Base-Rate Transition Band (Detail).....	17
Figure 8. Base-Rate Passband Ripple	17
Figure 9. High-Rate Stopband Rejection.....	17
Figure 10. High-Rate Transition Band	17
Figure 11. High-Rate Transition Band (Detail)	18
Figure 12. High-Rate Passband Ripple	18
Figure 13. Output Test Load.....	18
Figure 14. Maximum Loading	18
Figure 15. Power vs. Sample Rate (VA = 5V)	18
Figure 16. CS4340 Format 0 (I ² S).....	19
Figure 17. CS4340 Format 1	19
Figure 18. CS4340 Format 2	20
Figure 19. CS4340 Format 3	20
Figure 20. De-Emphasis Curve	21
Figure 21. FFT 0 dB input, BRM, VA = 3V	22
Figure 22. FFT -60 dB input, BRM, VA = 3V	22
Figure 23. FFT Idle Noise, BRM, VA = 3V.....	22
Figure 24. Fade-to-Noise Linearity, BRM, VA = 3V.....	22
Figure 25. THDN vs Ampl, BRM, VA = 3V	22
Figure 26. THDN vs Freq, BRM, VA = 3V	22
Figure 27. FFT 0 dB input, BRM, VA = 5V	23
Figure 28. FFT -60 dB input, BRM, VA = 5V	23
Figure 29. FFT Idle Noise, BRM, VA = 5V.....	23
Figure 30. Fade-to-Noise Linearity, BRM, VA = 5V.....	23
Figure 31. THDN vs Ampl, BRM, VA = 5V	23
Figure 32. THDN vs Freq, BRM, VA = 5V	23
Figure 33. FFT 0 dB input, HRM, VA = 3V	24
Figure 34. FFT -60 dB input, HRM, VA = 3V	24
Figure 35. FFT Idle Noise, HRM, VA = 3V	24
Figure 36. Fade-to-Noise Linearity, HRM, VA = 3V.....	24
Figure 37. THDN vs Ampl, HRM, VA = 3V	24
Figure 38. THDN vs Freq, HRM, VA = 3V	24
Figure 39. FFT 0 dB input, HRM, VA = 5V	25
Figure 40. FFT -60 dB input, HRM, VA = 5V	25
Figure 41. FFT Idle Noise, HRM, VA = 5V	25
Figure 42. Fade-to-Noise Linearity, HRM, VA = 5V.....	25
Figure 43. THDN vs Ampl, HRM, VA = 5V	25
Figure 44. THDN vs Freq, HRM, VA = 5V	25

LIST OF TABLES

Table 1. Internal Serial Clock Mode	14
Table 2. External Serial Clock Mode	14
Table 3. Common Master Clock Frequencies	14
Table 4. Digital Interface Format - DIF1 and DIF0	15

1. CHARACTERISTICS AND SPECIFICATIONS

ANALOG CHARACTERISTICS

(Test conditions (unless otherwise specified): $T_A = 25\text{ }^\circ\text{C}$; Logic "1" = $V_A = 5\text{ V}$; Logic "0" = AGND; Full-Scale Output Sine Wave, 997 Hz; MCLK = 12.288 MHz; F_s for Base-rate Mode = 48 kHz, SCLK = 3.072 MHz, Measurement Bandwidth 10 Hz to 20 kHz, unless otherwise specified; F_s for High-Rate Mode = 96 kHz, SCLK = 6.144 MHz, Measurement Bandwidth 10 Hz to 40 kHz, unless otherwise specified. Test load $R_L = 10\text{ k}\Omega$, $C_L = 10\text{ pF}$ (see Figure 13))

Parameter	Symbol	Base-rate Mode			High-Rate Mode			Unit		
		Min	Typ	Max	Min	Typ	Max			
CS4340-KS Dynamic Performance for $V_A = 5\text{ V}$ (Note 1)										
Specified Temperature Range	T_A	-10	-	70	-10	-	70	$^\circ\text{C}$		
Dynamic Range (Note 2) 18 to 24-Bit	unweighted	93	98	-	91	96	-	dB		
	A-Weighted	96	101	-	95	100	-	dB		
	16-Bit unweighted	-	95	-	-	94	-	dB		
	A-Weighted	-	97	-	-	97	-	dB		
Total Harmonic Distortion + Noise (Note 2)	18 to 24-Bit	0 dB	THD+N	-	-91	-86	-	-89	-84	dB
		-20 dB	-	-78	-	-	-76	-	dB	
		-60 dB	-	-38	-	-	-36	-	dB	
	16-Bit	0 dB	-	-90	-	-	-89	-	dB	
		-20 dB	-	-75	-	-	-74	-	dB	
		-60 dB	-	-35	-	-	-34	-	dB	
Interchannel Isolation (1 kHz)		-	102	-	-	102	-	dB		
CS4340-KS Dynamic Performance for $V_A = 3\text{ V}$ (Note 1)										
Specified Temperature Range	T_A	-10	-	70	-10	-	70	$^\circ\text{C}$		
Dynamic Range (Note 2) 18 to 24-Bit	unweighted	89	94	-	87	92	-	dB		
	A-Weighted	92	97	-	91	96	-	dB		
	16-Bit unweighted	-	93	-	-	92	-	dB		
	A-Weighted	-	96	-	-	96	-	dB		
Total Harmonic Distortion + Noise (Note 2)	18 to 24-Bit	0 dB	THD+N	-	-94	-88	-	-92	-87	dB
		-20 dB	-	-74	-	-	-72	-	dB	
		-60 dB	-	-34	-	-	-32	-	dB	
	16-Bit	0 dB	-	-93	-	-	-91	-	dB	
		-20 dB	-	-73	-	-	-72	-	dB	
		-60 dB	-	-33	-	-	-32	-	dB	
Interchannel Isolation (1 kHz)		-	102	-	-	102	-	dB		

- Notes:
- CS4340-KS parts are tested at $25\text{ }^\circ\text{C}$ and Min/Max performance numbers are guaranteed across the specified temperature range, T_A .
 - One-half LSB of triangular PDF dither is added to data.

ANALOG CHARACTERISTICS (Continued)

Parameter	Symbol	Base-rate Mode			High-Rate Mode			Unit		
		Min	Typ	Max	Min	Typ	Max			
CS4340-BS Dynamic Performance for VA = 5 V (Note 3)										
Specified Temperature Range	T _A	-40	-	85	-40	-	85	°C		
Dynamic Range (Note 2) 18 to 24-Bit	unweighted	TBD	98	-	TBD	96	-	dB		
	A-Weighted	TBD	101	-	TBD	100	-	dB		
	16-Bit unweighted	-	95	-	-	94	-	dB		
	A-Weighted	-	97	-	-	97	-	dB		
Total Harmonic Distortion + Noise (Note 2)	18 to 24-Bit	0 dB	THD+N	-	-91	TBD	-	-89	TBD	dB
		-20 dB	-	-78	-	-	-76	-	dB	
		-60 dB	-	-38	-	-	-36	-	dB	
	16-Bit	0 dB	-	-90	-	-	-89	-	dB	
		-20 dB	-	-75	-	-	-74	-	dB	
		-60 dB	-	-35	-	-	-34	-	dB	
Interchannel Isolation (1 kHz)		-	102	-	-	102	-	dB		
CS4340-BS Dynamic Performance for VA = 3 V (Note 3)										
Specified Temperature Range	T _A	-40	-	85	-40	-	85	°C		
Dynamic Range (Note 2) 18 to 24-Bit	unweighted	TBD	94	-	TBD	92	-	dB		
	A-Weighted	TBD	97	-	TBD	96	-	dB		
	16-Bit unweighted	-	93	-	-	92	-	dB		
	A-Weighted	-	96	-	-	96	-	dB		
Total Harmonic Distortion + Noise (Note 2)	18 to 24-Bit	0 dB	THD+N	-	-94	TBD	-	-92	TBD	dB
		-20 dB	-	-74	-	-	-72	-	dB	
		-60 dB	-	-34	-	-	-32	-	dB	
	16-Bit	0 dB	-	-93	-	-	-91	-	dB	
		-20 dB	-	-73	-	-	-72	-	dB	
		-60 dB	-	-33	-	-	-32	-	dB	
Interchannel Isolation (1 kHz)		-	102	-	-	102	-	dB		

Notes: 3. CS4340-BS parts are tested at the extremes of the specified temperature range and Min/Max performance numbers are guaranteed across the specified temperature range, T_A. Typical numbers are taken at 25 °C.

ANALOG CHARACTERISTICS (Continued)

Parameters	Symbol	Min	Typ	Max	Units
Analog Output					
Full Scale Output Voltage		0.63•VA	0.7•VA	0.77•VA	Vpp
Quiescent Voltage	V_Q	-	0.5•VA	-	VDC
Interchannel Gain Mismatch		-	0.1	-	dB
Gain Drift		-	100	-	ppm/°C
AC-Load Resistance (Note 4)	R_L	3	-	-	k Ω
Load Capacitance (Note 4)	C_L	-	-	100	pF

Parameter	Symbol	Base-rate Mode			High-Rate Mode			Unit
		Min	Typ	Max	Min	Typ	Max	
Combined Digital and On-chip Analog Filter Response (Note 5)								
Passband (Note 6) to -0.05 dB corner to -0.1 dB corner to -3 dB corner		0	-	.4535	-	-	-	Fs
		-	-	-	0	-	.4621	Fs
		0	-	.4998	0	-	.4982	Fs
Frequency Response 10 Hz to 20 kHz		-.02	-	+.08	-0.06	-	0.2	dB
StopBand		.5465	-	-	.577	-	-	Fs
StopBand Attenuation (Note 7)		50	-	-	55	-	-	dB
Group Delay	tgd	-	9/Fs	-	-	4/Fs	-	s
Passband Group Delay Deviation 0 - 40 kHz 0 - 20 kHz		-	-	-	-	$\pm 1.39/Fs$	-	s
		-	$\pm 0.36/Fs$	-	-	$\pm 0.23/Fs$	-	s
De-emphasis Error (Relative to 1 kHz)	Fs = 32 kHz	-	-	+.2/- .1	(Note 8)			dB
	Fs = 44.1 kHz	-	-	+.05/- .14				dB
	Fs = 48 kHz	-	-	+0/- .22				dB

- Notes:
- Refer to Figure 14.
 - Filter response is guaranteed by design.
 - Response is clock dependent and will scale with Fs. Note that the response plots (Figures 5-12) have been normalized to Fs and can be de-normalized by multiplying the X-axis scale by Fs.
 - For Base-Rate Mode, the measurement bandwidth is 0.5465 Fs to 3 Fs.
For High-Rate Mode, the measurement bandwidth is 0.577 Fs to 1.4 Fs.
 - De-emphasis is not available in High-Rate Mode.

POWER AND THERMAL CHARACTERISTICS

Parameters		Symbol	CS4340-KS			CS4340-BS			Units
			Min	Typ	Max	Min	Typ	Max	
Power Supplies									
Power Supply Current VA = 5 V	normal operation	I_A	-	15	18	-	15	TBD	mA
	power-down state	I_A	-	60	-	-	60	-	μ A
Power Dissipation VA = 5 V	(Note 9) normal operation		-	75	90	-	75	TBD	mW
	power-down		-	0.3	-	-	0.3	-	mW
Power Supply Current VA = 3 V	normal operation	I_A	-	10	14	-	10	TBD	mA
	power-down state	I_A	-	30	-	-	30	-	μ A
Power Dissipation VA = 3 V	(Note 9) normal operation		-	30	42	-	30	TBD	mW
	power-down		-	0.09	-	-	0.09	-	mW
Package Thermal Resistance		θ_{JA}	-	110	-	-	110	-	$^{\circ}$ C/Watt
Power Supply Rejection Ratio (1 kHz)	(Note 10) (60 Hz)	PSRR	-	60	-	-	60	-	dB
			-	40	-	-	40	-	dB

Notes: 9. Refer to Figure 15.

10. Valid with the recommended capacitor values on FILT+ and VQ as shown in Figure 4. Increasing the capacitance will also increase the PSRR.

DIGITAL CHARACTERISTICS (for -KS parts $T_A = -10$ to 70° C; for -BS parts $T_A = -40$ to 85° C; VA = 2.7 V - 5.5 V)

Parameters	Symbol	Min	Typ	Max	Units	
High-Level Input Voltage	VA = 5 V	V_{IH}	2.0	-	-	V
	VA = 3 V		2.0	-	-	V
Low-Level Input Voltage	VA = 5 V	V_{IL}	-	-	0.8	V
	VA = 3 V		-	-	0.8	V
Input Leakage Current	I_{in}	-	-	± 10	μ A	
Input Capacitance		-	8	-	pF	
Maximum MUTE _C Drive Current		-	3	-	mA	

ABSOLUTE MAXIMUM RATINGS (AGND = 0 V; all voltages with respect to ground.)

Parameters	Symbol	Min	Max	Units
DC Power Supply	VA	-0.3	6.0	V
Input Current, Any Pin Except Supplies	I _{in}	-	±10	mA
Digital Input Voltage	V _{IND}	-0.3	VA+0.4	V
Ambient Operating Temperature (power applied)	T _A	-55	125	°C
Storage Temperature	T _{stg}	-65	150	°C

WARNING: Operation at or beyond these limits may result in permanent damage to the device. Normal operation is not guaranteed at these extremes.

RECOMMENDED OPERATING CONDITIONS (AGND = 0V; all voltages with respect to ground.)

Parameters	Symbol	Min	Typ	Max	Units
DC Power Supply	VA	2.7	5.0	5.5	V

SWITCHING CHARACTERISTICS ($V_A = 2.7\text{ V} - 5.5\text{ V}$; Inputs: Logic 0 = 0 V, Logic 1 = V_A , $CL = 20\text{ pF}$; for -KS parts $T_A = -10\text{ to }70^\circ\text{C}$; for -BS parts $T_A = -40\text{ to }85^\circ\text{C}$)

Parameters	Symbol	Min	Typ	Max	Units
Input Sample Rate	Fs	Base-Rate Mode	-	50	kHz
		High-Rate Mode	-	100	
MCLK Pulse Width High	MCLK/LRCK = 512	10	-	1000	ns
MCLK Pulse Width Low	MCLK/LRCK = 512	10	-	1000	ns
MCLK Pulse Width High	MCLK / LRCK = 384 or 192	21	-	1000	ns
MCLK Pulse Width Low	MCLK / LRCK = 384 or 192	21	-	1000	ns
MCLK Pulse Width High	MCLK / LRCK = 256 or 128	31	-	1000	ns
MCLK Pulse Width Low	MCLK / LRCK = 256 or 128	31	-	1000	ns
External SCLK Mode					
LRCK Duty Cycle (External SCLK only)		40	50	60	%
SCLK Pulse Width Low	t_{sckl}	20	-	-	ns
SCLK Pulse Width High	t_{sckh}	20	-	-	ns
SCLK Period	MCLK / LRCK = 512, 256 or 384 t_{sckw}	$\frac{1}{(128)F_s}$	-	-	ns
SCLK Period	MCLK / LRCK = 128 or 192 t_{sckw}	$\frac{1}{(64)F_s}$	-	-	ns
SCLK rising to LRCK edge delay	t_{slrd}	20	-	-	ns
SCLK rising to LRCK edge setup time	t_{slrs}	20	-	-	ns
SDATA valid to SCLK rising setup time	t_{sdhrs}	20	-	-	ns
SCLK rising to SDATA hold time	t_{sdh}	20	-	-	ns
Internal SCLK Mode					
LRCK Duty Cycle (Internal SCLK only)	(Note 11)	-	50	-	%
SCLK Period	(Note 12) t_{sckw}	$\frac{1}{SCLK}$	-	-	ns
SCLK rising to LRCK edge	t_{sckr}	-	$\frac{t_{sckw}}{2}$	-	μs
SDATA valid to SCLK rising setup time	t_{sdhrs}	$\frac{1}{(512)F_s} + 10$	-	-	ns
SCLK rising to SDATA hold time	MCLK / LRCK = 512, 256 or 128 t_{sdh}	$\frac{1}{(512)F_s} + 15$	-	-	ns
SCLK rising to SDATA hold time	MCLK / LRCK = 384 or 192 t_{sdh}	$\frac{1}{(384)F_s} + 15$	-	-	ns

Notes: 11. In Internal SCLK Mode, the Duty Cycle must be 50% +/- 1/2 MCLK Period.

12. The SCLK / LRCK ratio may be either 32, 48, or 64. This ratio depends on part type and MCLK/LRCK ratio. (See figures 16-19)

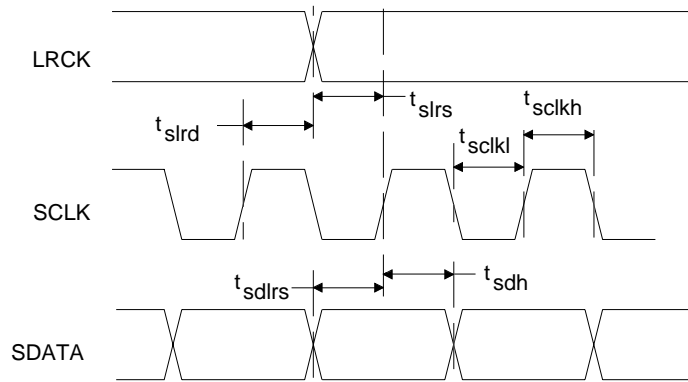

Figure 1. External Serial Mode Input Timing

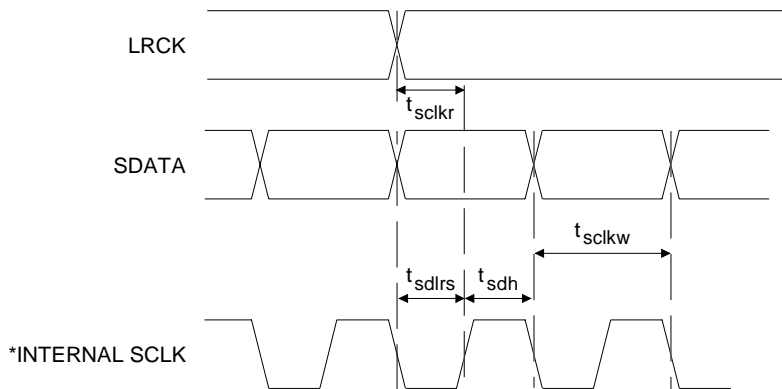

Figure 2. Internal Serial Mode Input Timing

*The SCLK pulses shown are internal to the CS4340.

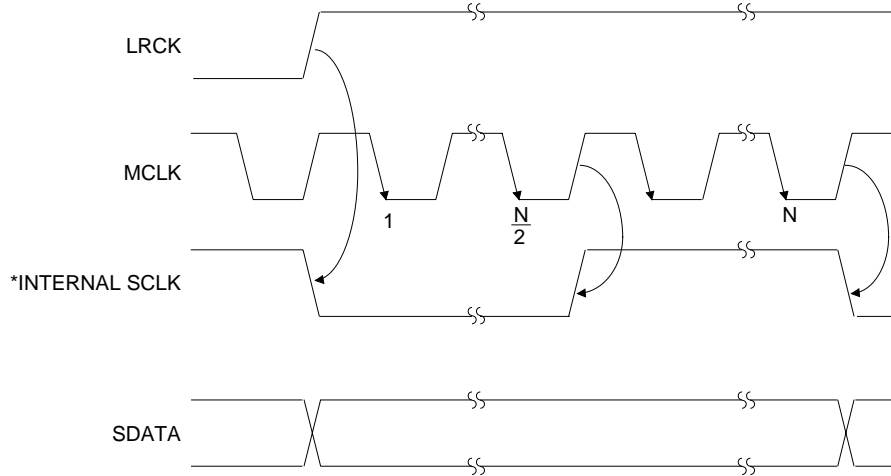

Figure 3. Internal Serial Clock Generation

* The SCLK pulses shown are internal to the CS4340.

N equals MCLK divided by SCLK

2. TYPICAL CONNECTION DIAGRAM

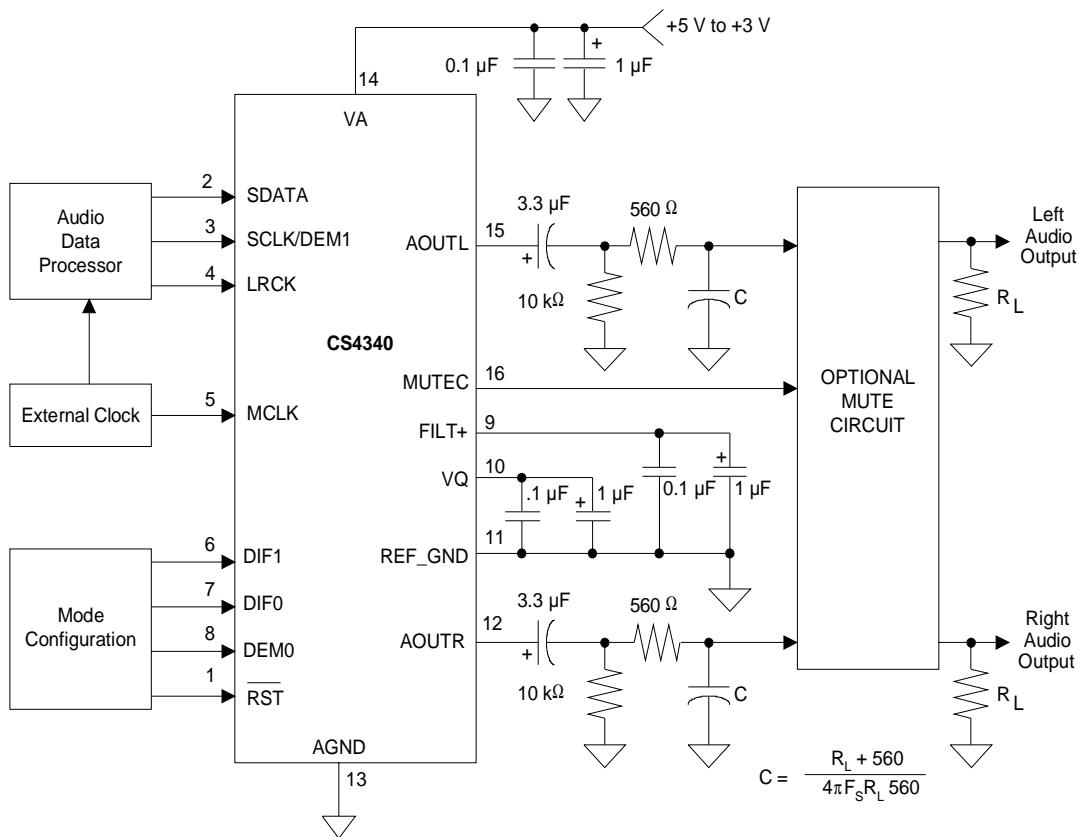

Figure 4. Typical Connection Diagram

3. PIN DESCRIPTION

Reset	RST	□ 1	□ 16	MUTEC	Mute Control
Serial Data	SDATA	□ 2	□ 15	AOUTL	Left Analog Output
Serial Clock / De-emphasis	SCLK/DEM1	□ 3	□ 14	VA	Analog Power
Left/Right Clock	LRCK	□ 4	□ 13	AGND	Analog Ground
Master Clock	MCLK	□ 5	□ 12	AOUTR	Right Analog Output
Digital Interface Format	DIF1	□ 6	□ 11	REF_GND	Reference Ground
Digital Interface Format	DIF0	□ 7	□ 10	VQ	Quiescent Voltage
De-emphasis	DEM0	□ 8	□ 9	FILT+	Positive Voltage Reference

RST	1	Reset (Input) - The device enters a low power mode and all internal state machines are reset to the default settings when low. $\overline{\text{RST}}$ should be held low during power-up until the power supply, master and left/right clocks are stable.
SDATA	2	Serial Audio Data (Input) - Two's complement MSB-first serial data is input on this pin. The data is clocked into SDATA via the serial clock and the channel is determined by the Left/Right clock. The required relationship between the Left/Right clock, serial clock and serial data is defined by the DIF1-0 pins. The options are detailed in Figures 16-19.
SCLK	3	<p>Serial Clock (Input) - Clocks the individual bits of the serial data into the SDATA pin. The required relationship between the Left/Right clock, serial clock and serial data is defined by the DIF1-0 pins. The options are detailed in Figures 16-19.</p> <p>The CS4340 supports both internal and external serial clock generation modes. Internal SCLK mode is used to gain access to extra de-emphasis modes.</p> <p><u>Internal Serial Clock Mode</u> - In the Internal Serial Clock Mode, the serial clock is internally derived and synchronous with the master clock and left/right clock. The SCLK/LRCK frequency ratio is either 32, 48, or 64 depending upon the DIF1-0 pins as shown in Figures 16-19. Operation in this mode is identical to operation with an external serial clock synchronized with LRCK.</p> <p><u>External Serial Clock Mode</u> - The CS4340 will enter the External Serial Clock Mode whenever 16 low to high transitions are detected on the SCLK pin during any phase of the LRCK period. The device will revert to Internal Serial Clock Mode if no low to high transitions are detected on the SCLK pin for 2 consecutive periods of LRCK.</p>

DEM1 and DEM0 3 & 8 **De-emphasis Control (Input)** - Implementation of the standard 15 μ s/50 μ s digital de-emphasis filter response, Figure 20, requires reconfiguration of the digital filter to maintain the proper filter response for 32, 44.1 or 48 kHz sample rates. When using Internal Serial Clock Mode, as described above, Pin 3 is available for de-emphasis control, DEM1, and all de-emphasis filters are available, Table 3. When using External Serial Clock Mode, as described above, Pin 3 is not available for de-emphasis use and only the 44.1 kHz de-emphasis filter is available, Table 4. NOTE: De-emphasis is not available in High-Rate Mode.

DEM1	DEMO	DESCRIPTION
0	0	Disabled
0	1	44.1kHz
1	0	48kHz
1	1	32kHz

Table 1. Internal Serial Clock Mode

DEMO	DESCRIPTION
0	Disabled
1	44.1kHz

Table 2. External Serial Clock Mode

LRCK 4 **Left/Right Clock (Input)** - The Left/Right clock determines which channel is currently being input on the serial audio data input, SDATA. The frequency of the Left/Right clock must be at the input sample rate. Audio samples in Left/Right sample pairs will be simultaneously output from the digital-to-analog converter whereas Right/Left pairs will exhibit a one sample period difference. The required relationship between the Left/Right clock, serial clock and serial data is defined by the DIF1-0 pins. The options are detailed in Figures 16-19.

MCLK 5 **Master Clock (Input)** - The master clock frequency must be either 256x, 384x or 512x the input sample rate in Base Rate Mode (BRM) and either 128x or 192x the input sample rate in High Rate Mode (HRM). Table 3 illustrates several standard audio sample rates and the required master clock frequencies.

Sample Rate (kHz)	MCLK (MHz)				
	HRM		BRM		
	128x	192x	256x	384x	512x
32	4.0960	6.1440	8.1920	12.2880	16.3840
44.1	5.6448	8.4672	11.2896	16.9344	22.5792
48	6.1440	9.2160	12.2880	18.4320	24.5760
64	8.1920	12.2880	-	-	-
88.2	11.2896	16.9344	-	-	-
96	12.2880	18.4320	-	-	-

Table 3. Common Master Clock Frequencies

DIF1 and DIF0 6 & 7 **Digital Interface Format (Input)** - The required relationship between the Left/Right clock, serial clock and serial data is defined by the Digital Interface Format and the options are detailed in Figures 16-19

DIF1	DIF0	DESCRIPTION	FORMAT	FIGURE
0	0	I ² S, up to 24-bit data	0	16
0	1	Left Justified, up to 24-bit data	1	17
1	0	Right Justified, 24-bit Data	2	18
1	1	Right Justified, 16-bit Data	3	19

Table 4. Digital Interface Format - DIF1 and DIF0

FILT+	9	Positive Voltage Reference (Output) - Positive reference for internal sampling circuits. An external capacitor is required from FILT+ to analog ground, as shown in Figure 4. The recommended value will typically provide 60 dB of PSRR at 1 kHz and 40 dB of PSRR at 60 Hz. FILT+ is not intended to supply external current. FILT+ has a typical source impedance of 250 kΩ and any current drawn from this pin will alter device performance.
VQ	10	Quiescent Voltage (Output) - Filter connection for internal quiescent reference voltage, typically 50% of VA. Capacitors must be connected from VQ to analog ground, as shown in Figure 4. VQ is not intended to supply external current. VQ has a typical source impedance of 250 kΩ and any current drawn from this pin will alter device performance.
REF_GND	11	Reference Ground (Input) - Ground reference for the internal sampling circuits. Must be connected to analog ground.
AOUTR and AOUTL	12 & 15	Analog Outputs (Output) - The full scale analog output level is specified in the Analog Characteristics specifications table.
AGND	13	Ground (Input) - Ground Reference.
VA	14	Analog Power (Input) - Analog power supply. Typically 3 to 5 VDC.
MUTEC	16	Mute Control (Output) - The Mute Control pin goes high during power-up initialization, reset, muting, master clock to left/right clock frequency ratio is incorrect or power-down. This pin is intended to be used as a control for an external mute circuit to prevent the clicks and pops that can occur in any single supply system. Use of Mute Control is not mandatory but recommended for designs requiring the absolute minimum in extraneous clicks and pops.

4. APPLICATIONS

4.1 Grounding and Power Supply Decoupling

As with any high resolution converter, the CS4340 requires careful attention to power supply and grounding arrangements to optimize performance. Figure 4 shows the recommended power arrangement with VA connected to a clean supply. Decoupling capacitors should be located as close to the device package as possible.

4.2 Oversampling Modes

The CS4340 operates in one of two oversampling modes. Base Rate Mode supports input sample rates up to 50 kHz while High Rate Mode supports input sample rates up to 100 kHz. The devices operate in Base Rate Mode (BRM) when MCLK/LRCK is 256, 384 or 512 and in High Rate Mode (HRM) when MCLK/LRCK is 128 or 192.

4.3 Recommended Power-up Sequence

$\overline{\text{RST}}$ should be held low until the power supply, master and left/right clocks are stable.

4.4 Popguard[®] Transient Control

The CS4340 uses Popguard[®] technology to minimize the effects of output transients during power-up and power-down. This technique, when used with external DC-blocking capacitors in series with the audio outputs, minimizes the audio transients commonly produced by single-ended single-supply converters.

When the device is initially powered-up, the audio outputs, AOUTL and AOUTR, are clamped to AGND. Following a delay of approximately 1000 sample periods, each output begins to ramp toward the quiescent voltage. Approximately 10,000 left/right clock cycles later, the outputs reach V_Q and audio output begins. This gradual voltage ramping allows time for the external DC-blocking capacitor to charge to the quiescent voltage, minimizing the power-up transient.

To prevent transients at power-down, the device must first enter its power-down state by setting the $\overline{\text{RST}}$ pin low. When this occurs, audio output ceases and the internal output buffers are disconnected from AOUTL and AOUTR. In their place, a soft-start current sink is substituted which allows the DC-blocking capacitors to slowly discharge. Once this charge is dissipated, the power to the device may be turned off and the system is ready for the next power-on.

To prevent an audio transient at the next power-on, it is necessary to ensure that the DC-blocking capacitors have fully discharged before turning off the power or exiting the power-down state. If not, a transient will occur when the audio outputs are initially clamped to AGND. The time that the device must remain in the power-down state is related to the value of the DC-blocking capacitance. For example, with a 3.3 μF capacitor, the minimum power-down time will be approximately 0.4 seconds.

Use of the Mute Control function is recommended for designs requiring the absolute minimum in extraneous clicks and pops. Also, use of the Mute Control function can enable the system designer to achieve idle channel noise/signal-to-noise ratios which are only limited by the external mute circuit. See the CDB4340/41 data sheet for a suggested mute circuit.

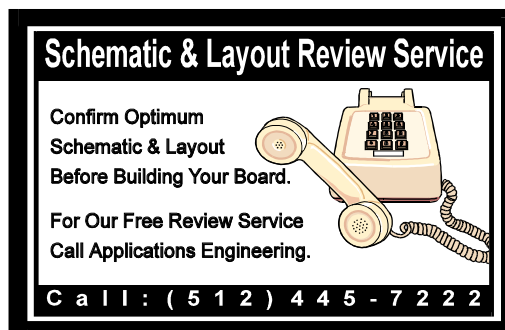

5. INTERPOLATION FILTER RESPONSE PLOTS

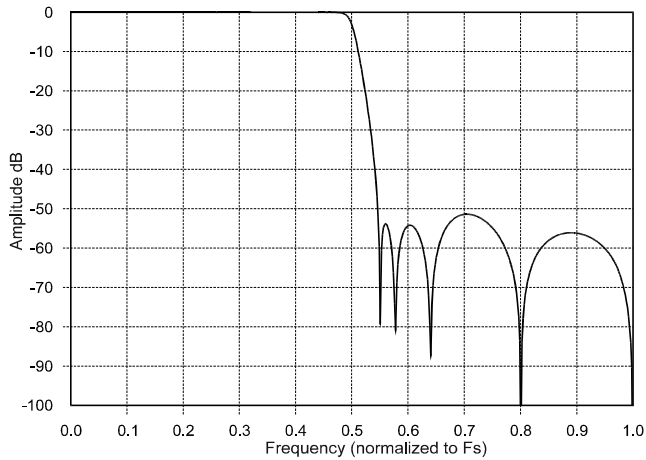

Figure 5. Base-Rate Stopband Rejection

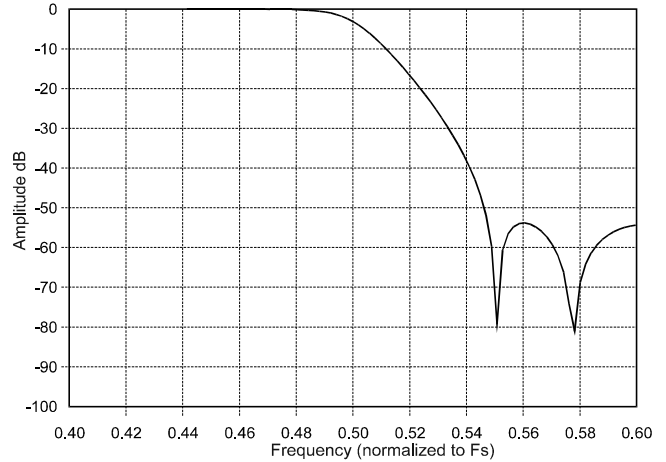

Figure 6. Base-Rate Transition Band

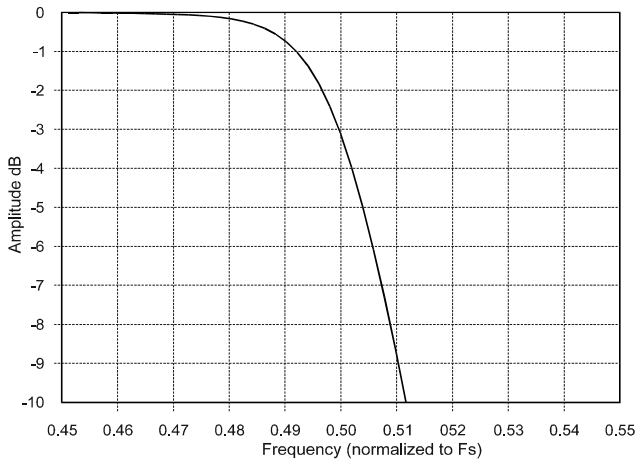

Figure 7. Base-Rate Transition Band (Detail)

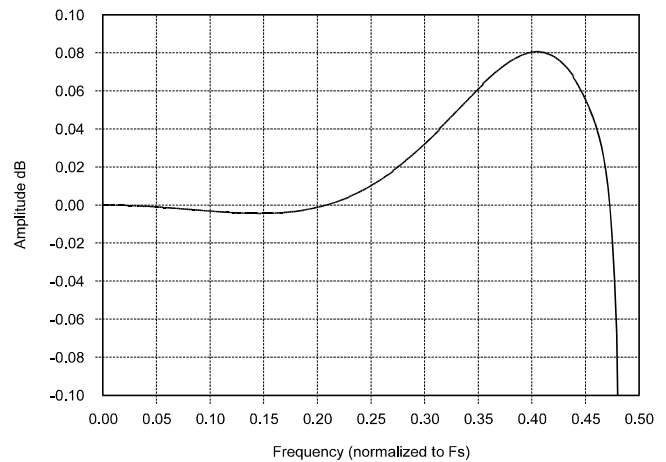

Figure 8. Base-Rate Passband Ripple

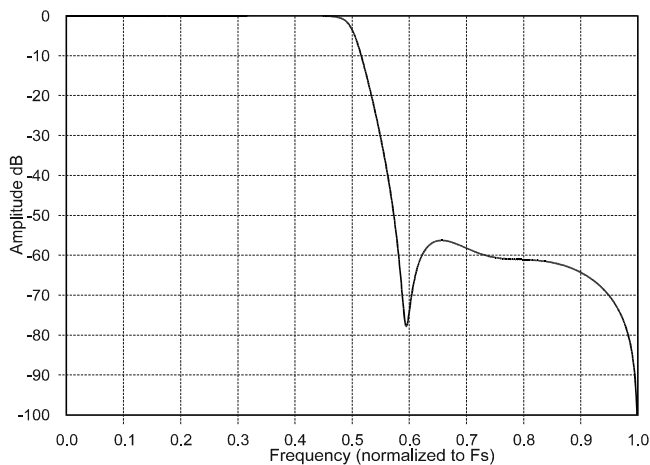

Figure 9. High-Rate Stopband Rejection

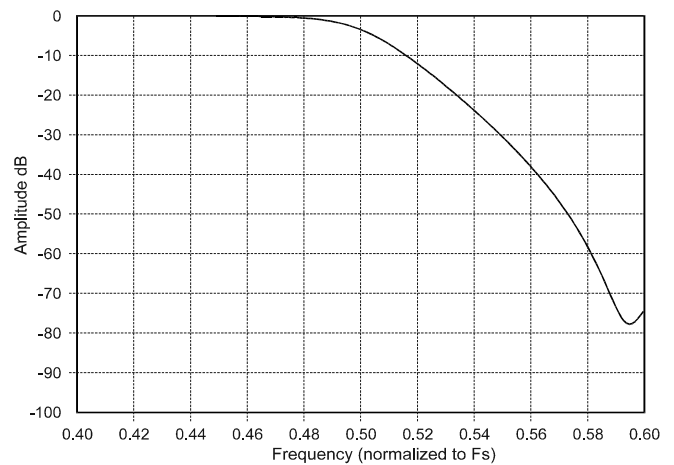

Figure 10. High-Rate Transition Band

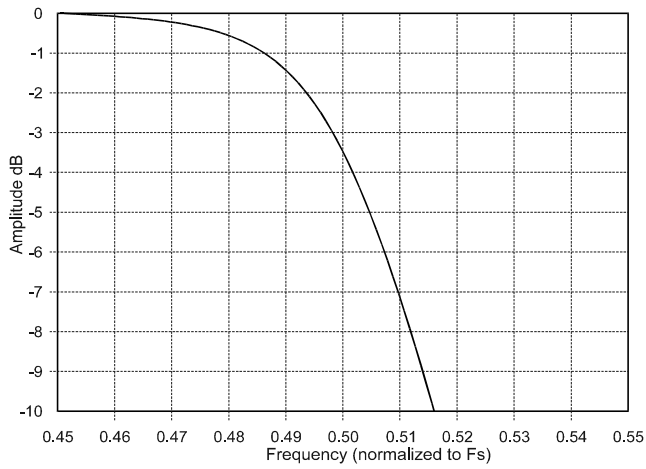

Figure 11. High-Rate Transition Band (Detail)

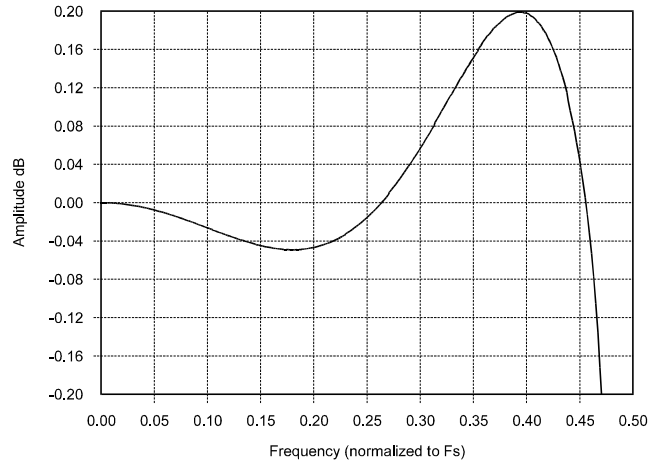

Figure 12. High-Rate Passband Ripple

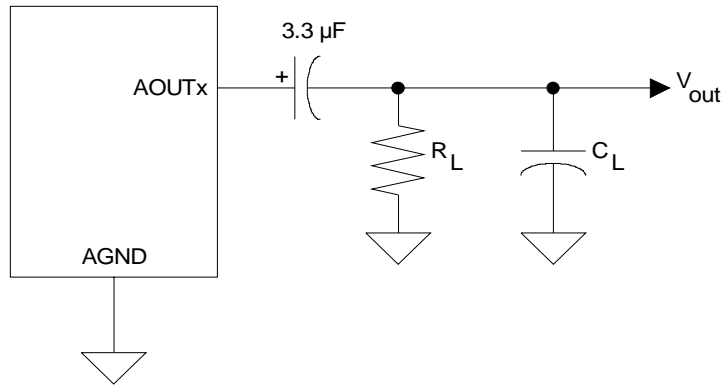

Figure 13. Output Test Load

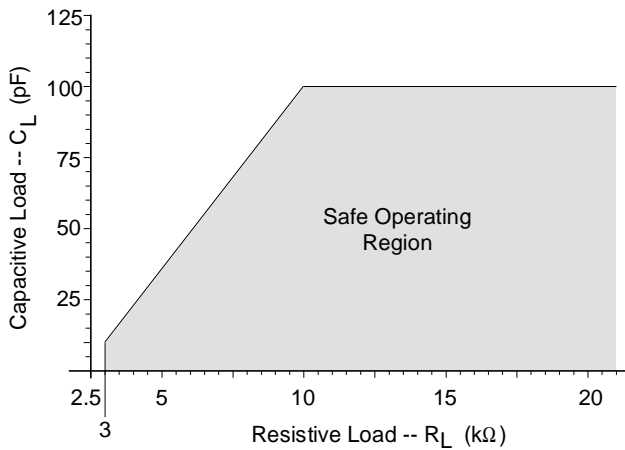

Figure 14. Maximum Loading

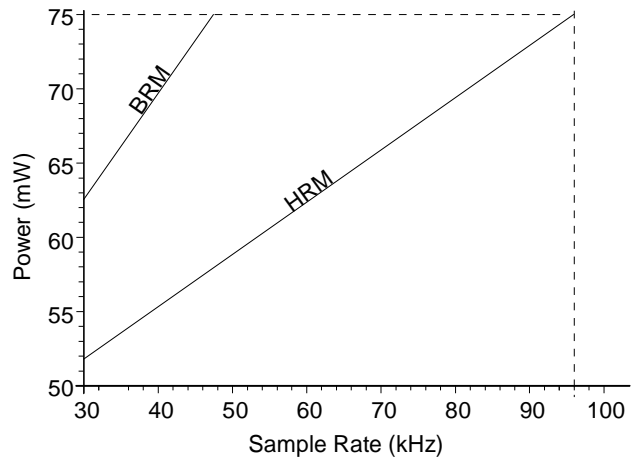
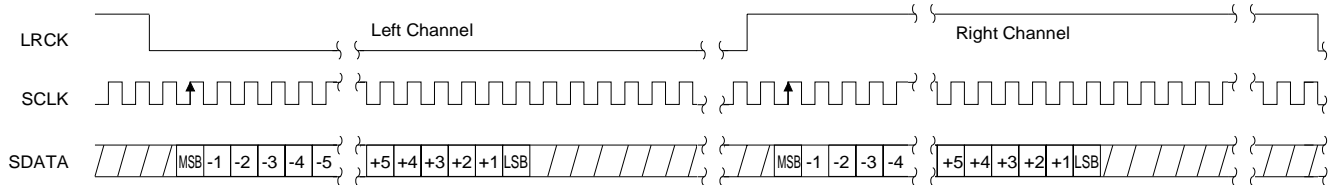

Figure 15. Power vs. Sample Rate (VA = 5V)

6. DIGITAL INTERFACE FORMATS



Internal SCLK Mode	External SCLK Mode
I^2S , 16-Bit data and INT SCLK = 32 Fs if MCLK/LRCK = 512, 256 or 128 I^2S , up to 24-Bit data and INT SCLK = 48 Fs if MCLK/LRCK = 384 or 192	I^2S , up to 24-Bit Data Data Valid on Rising Edge of SCLK

Figure 16. CS4340 Format 0 (I^2S)

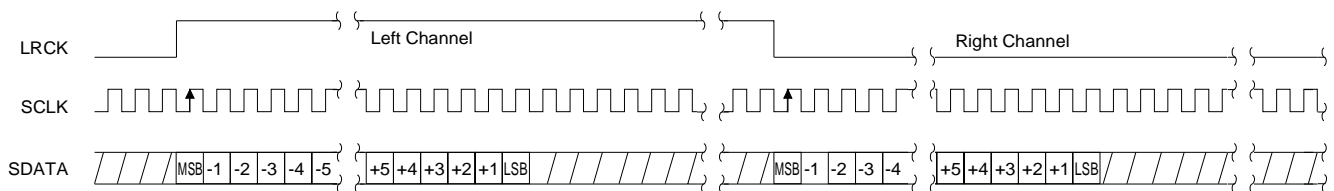

Internal SCLK Mode	External SCLK Mode
Left Justified, up to 24-Bit Data INT SCLK = 64 Fs if MCLK/LRCK = 512, 256 or 128 INT SCLK = 48 Fs if MCLK/LRCK = 384 or 192	Left Justified, up to 24-Bit Data Data Valid on Rising Edge of SCLK

Figure 17. CS4340 Format 1

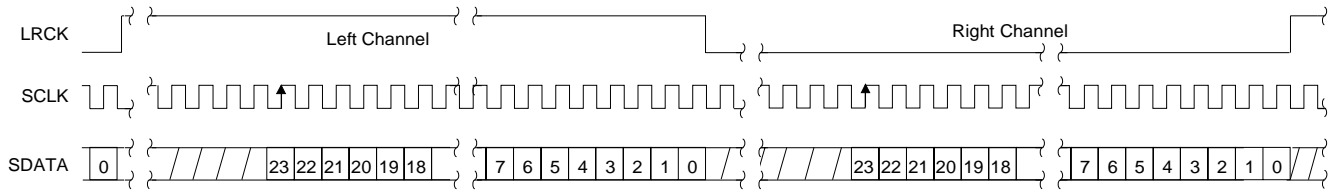

Internal SCLK Mode	External SCLK Mode
Right Justified, 24-Bit Data INT SCLK = 64 Fs if MCLK/LRCK = 512, 256 or 128 INT SCLK = 48 Fs if MCLK/LRCK = 384 or 192	Right Justified, 24-Bit Data Data Valid on Rising Edge of SCLK SCLK Must Have at Least 48 Cycles per LRCK Period

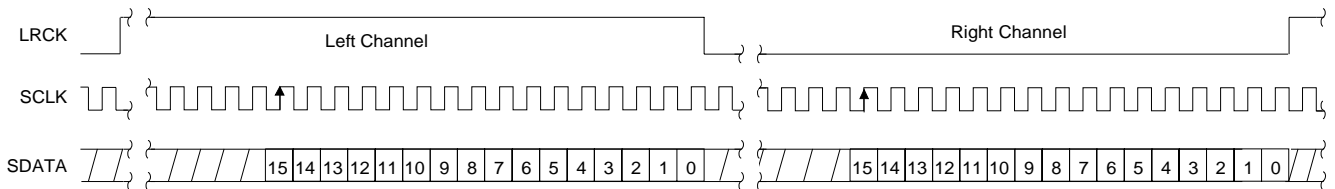
Figure 18. CS4340 Format 2

Internal SCLK Mode	External SCLK Mode
Right Justified, 16-Bit Data INT SCLK = 32 Fs if MCLK/LRCK = 512, 256 or 128 INT SCLK = 48 Fs if MCLK/LRCK = 384 or 192	Right Justified, 16-Bit Data Data Valid on Rising Edge of SCLK SCLK Must Have at Least 32 Cycles per LRCK Period

Figure 19. CS4340 Format 3

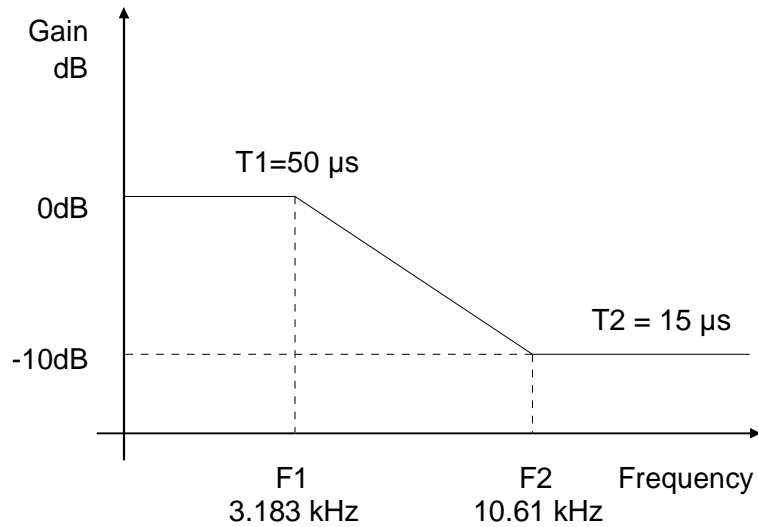

Figure 20. De-Emphasis Curve

7. ANALOG PERFORMANCE PLOTS

The following CS4340 Analog Performance Plots were taken from the CDB4340 evaluation board using the Audio Precision Dual Domain System Two Cascade. All Base Rate Mode (BRM) plots were taken at a 48 kHz sample rate with a 20 Hz to 20 kHz bandwidth using a 20 kHz low-pass brick-

wall filter in the DSP Analyzer. All High Rate Mode (HRM) plots were taken at a 96 kHz sample rate with a 20 Hz to 40 kHz bandwidth using a 40 kHz brickwall filter in the DSP Analyzer.

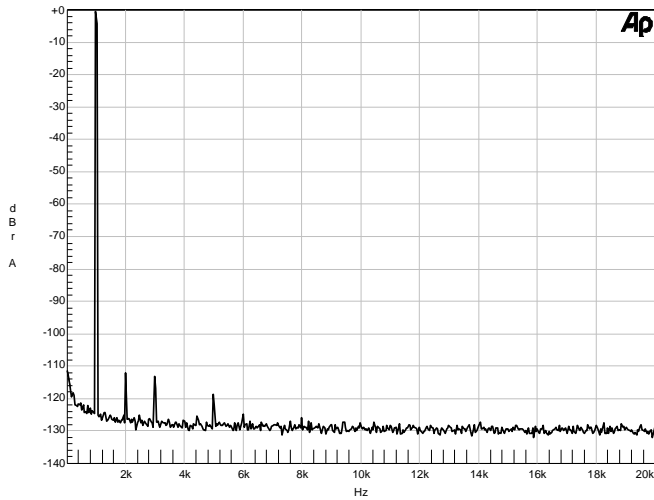

Figure 21. FFT 0 dB input, BRM, VA = 3V

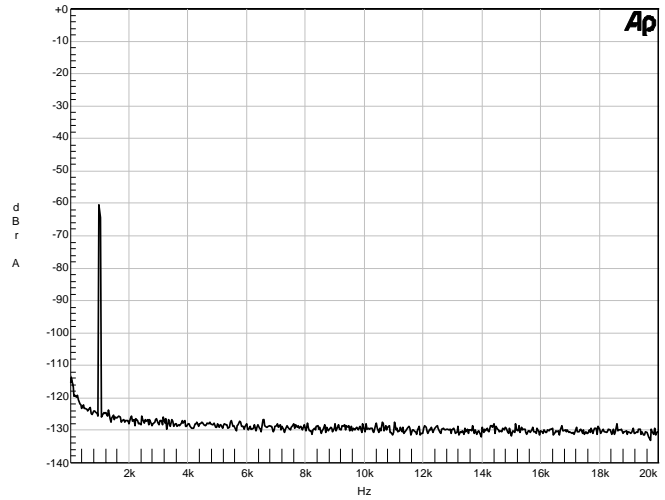

Figure 22. FFT -60 dB input, BRM, VA = 3V

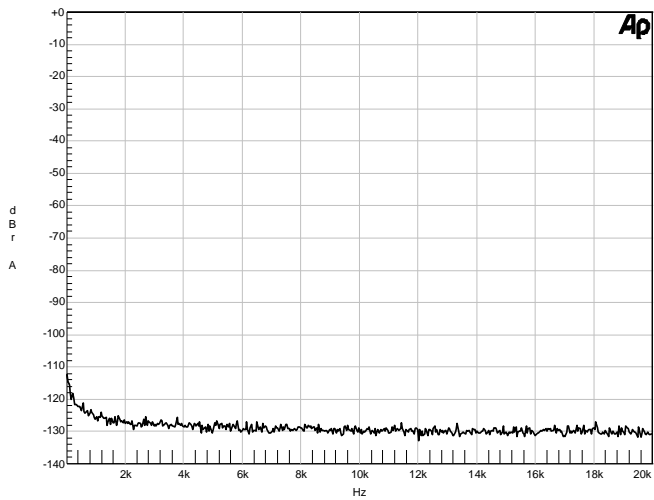

Figure 23. FFT Idle Noise, BRM, VA = 3V

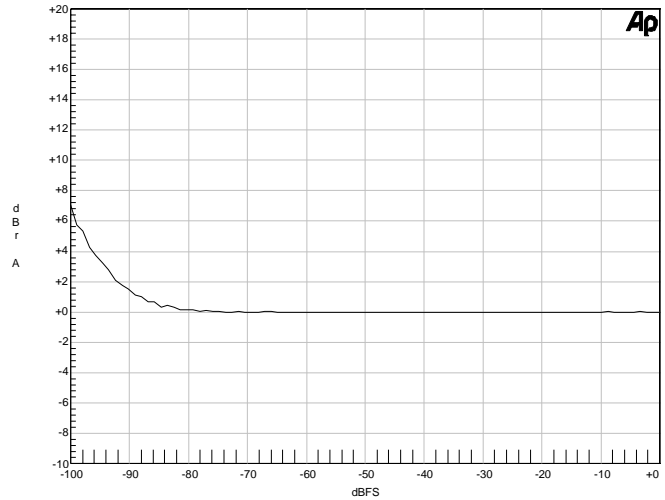

Figure 24. Fade-to-Noise Linearity, BRM, VA = 3V

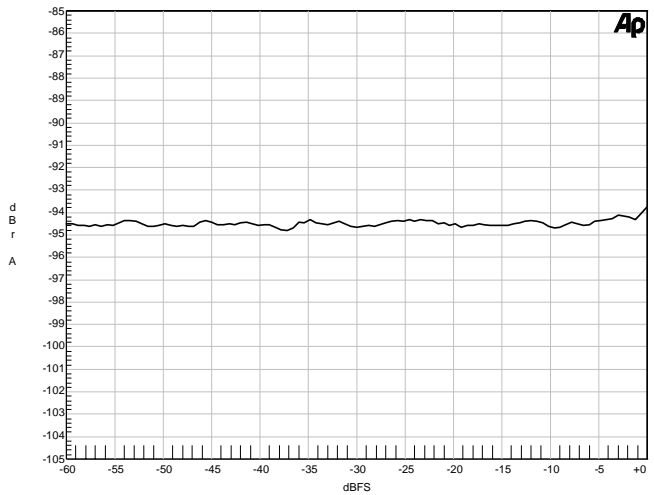

Figure 25. THDN vs Ampl, BRM, VA = 3V

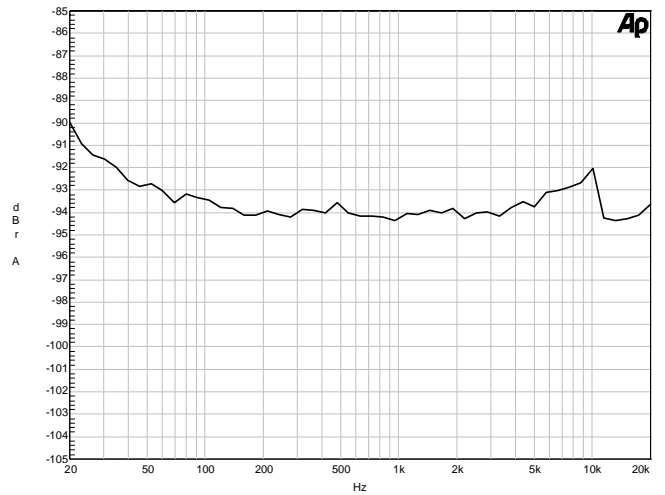

Figure 26. THDN vs Freq, BRM, VA = 3V

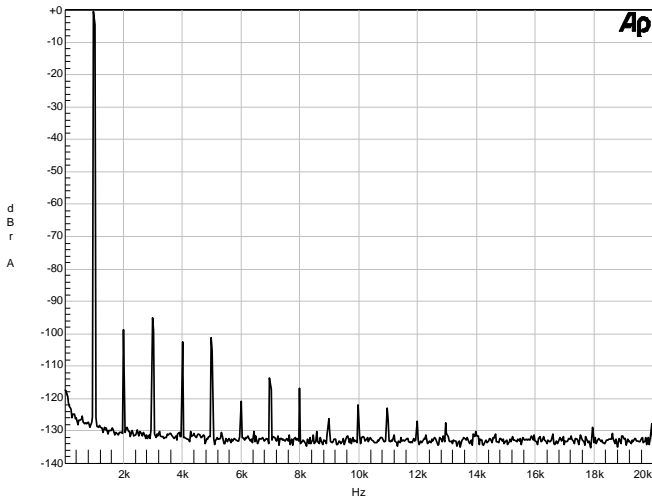

Figure 27. FFT 0 dB input, BRM, VA = 5V

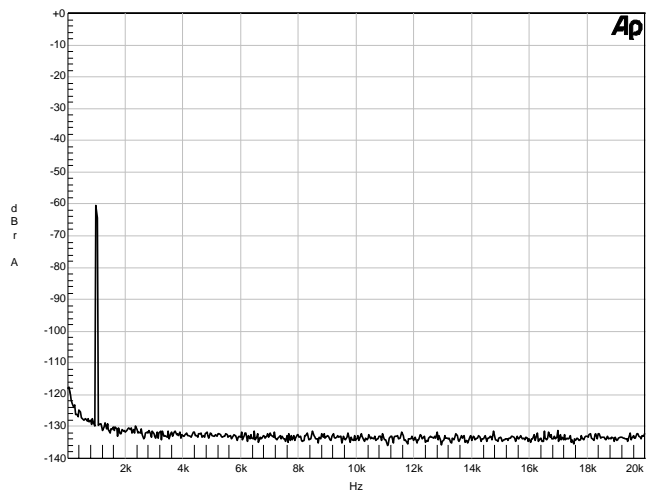

Figure 28. FFT -60 dB input, BRM, VA = 5V

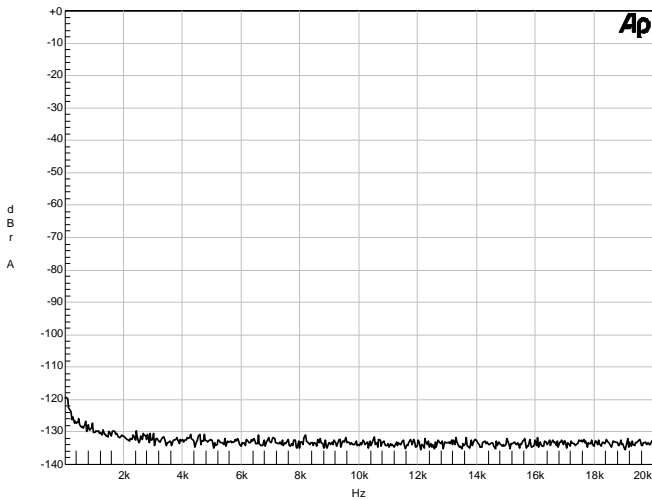

Figure 29. FFT Idle Noise, BRM, VA = 5V

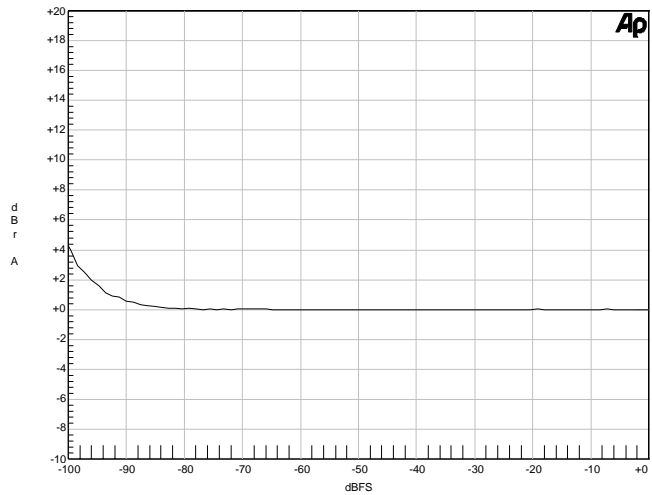

Figure 30. Fade-to-Noise Linearity, BRM, VA = 5V

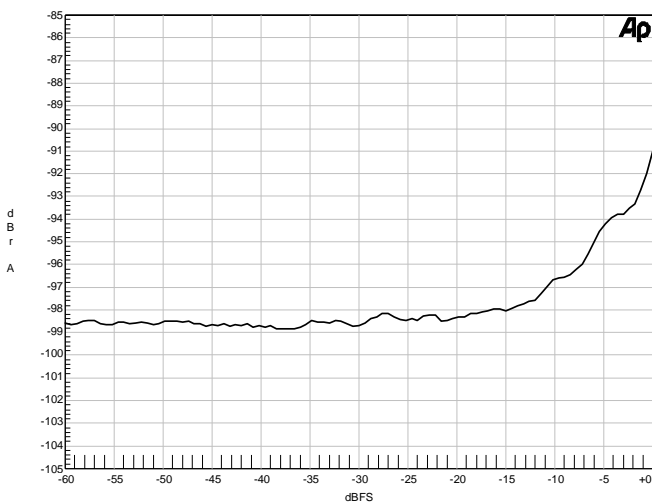

Figure 31. THDN vs Ampl, BRM, VA = 5V

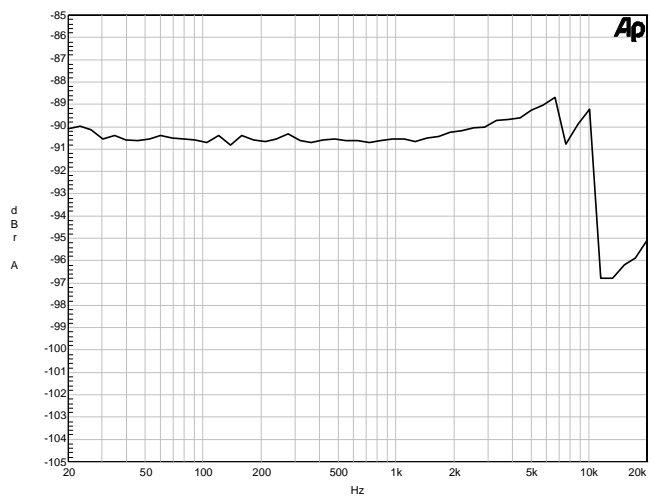

Figure 32. THDN vs Freq, BRM, VA = 5V

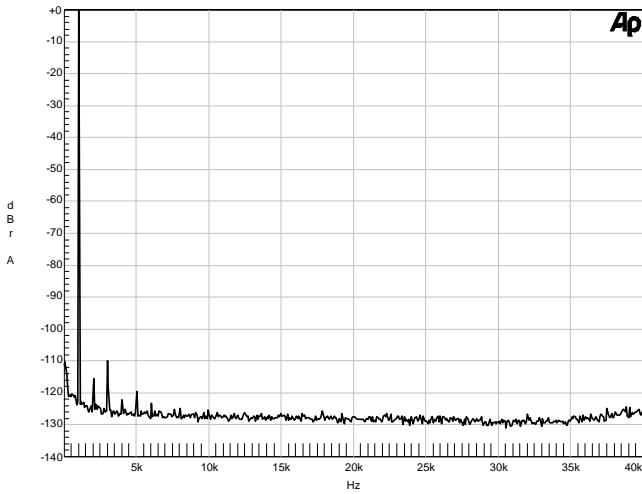

Figure 33. FFT 0 dB input, HRM, VA = 3V

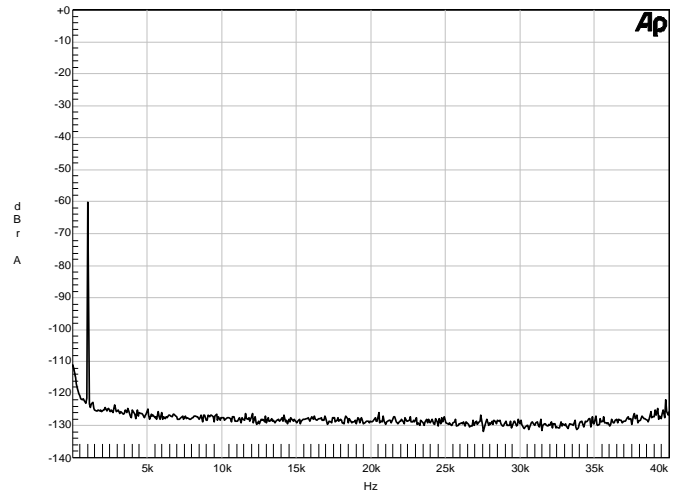

Figure 34. FFT -60 dB input, HRM, VA = 3V

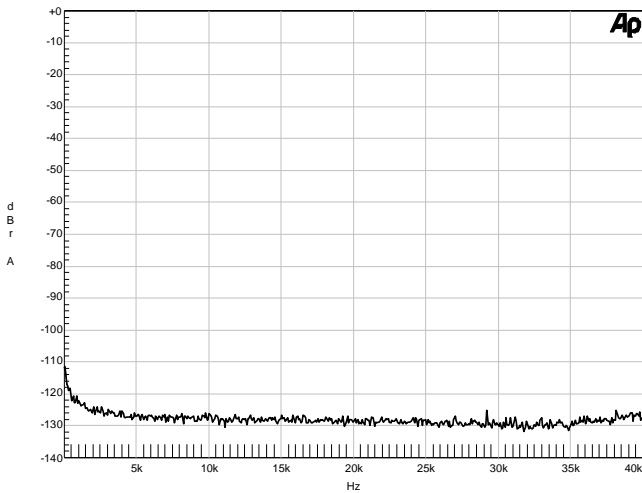

Figure 35. FFT Idle Noise, HRM, VA = 3V

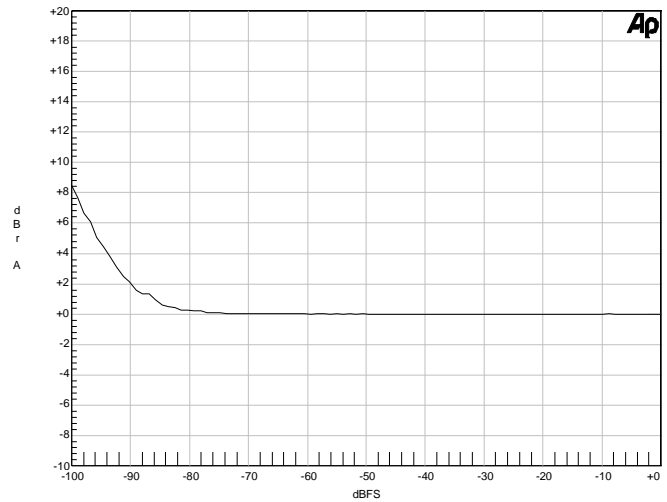

Figure 36. Fade-to-Noise Linearity, HRM, VA = 3V

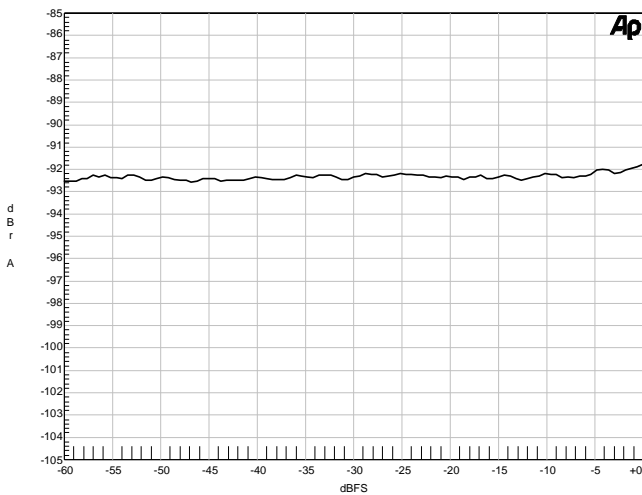

Figure 37. THDN vs Ampl, HRM, VA = 3V

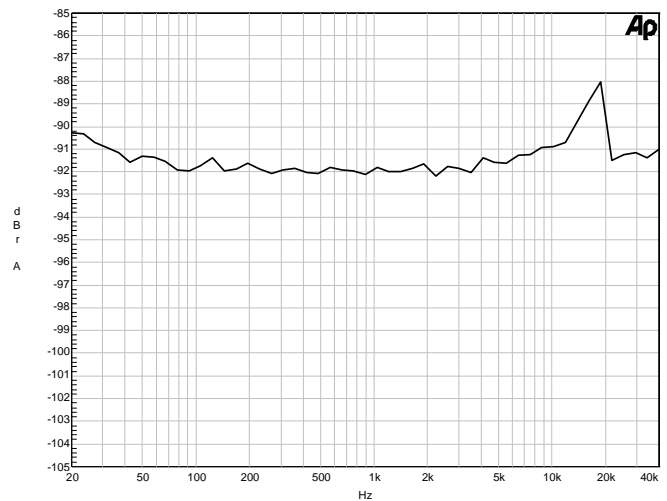

Figure 38. THDN vs Freq, HRM, VA = 3V

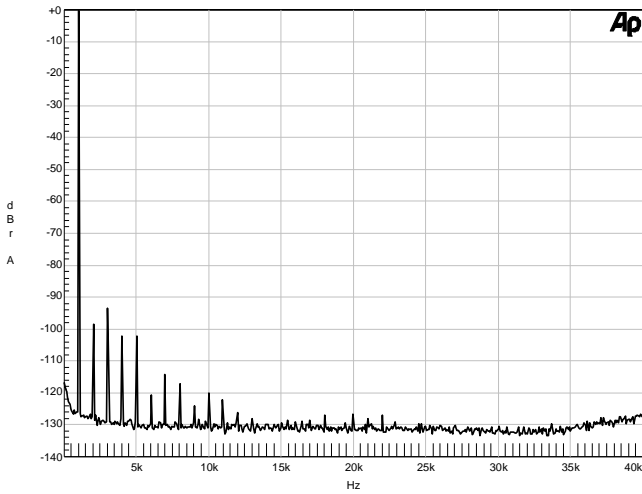

Figure 39. FFT 0 dB input, HRM, VA = 5V

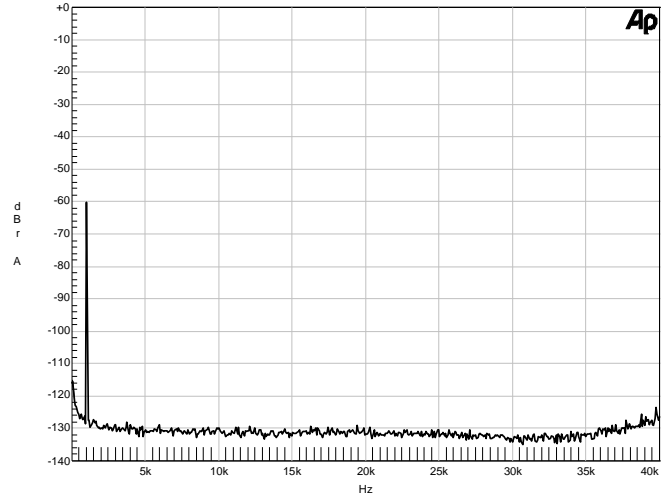

Figure 40. FFT -60 dB input, HRM, VA = 5V

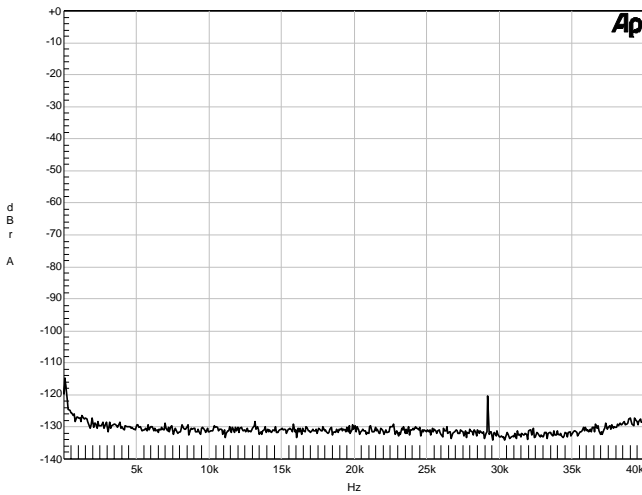

Figure 41. FFT Idle Noise, HRM, VA = 5V

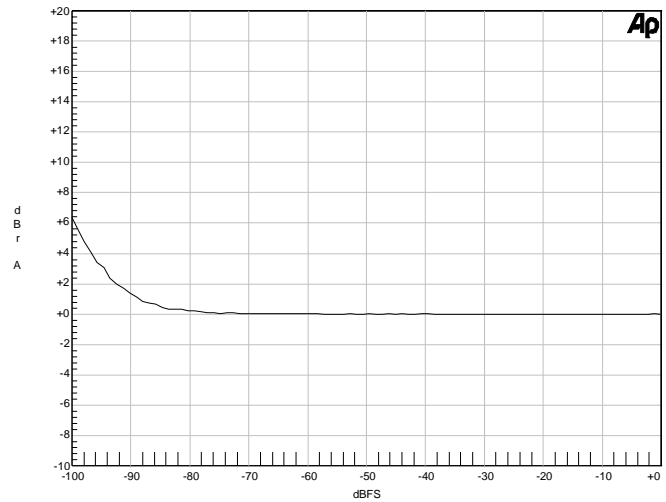

Figure 42. Fade-to-Noise Linearity, HRM, VA = 5V

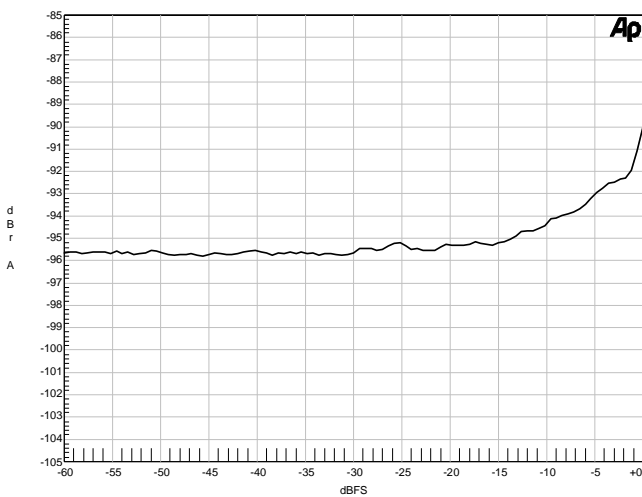

Figure 43. THDN vs Ampl, HRM, VA = 5V

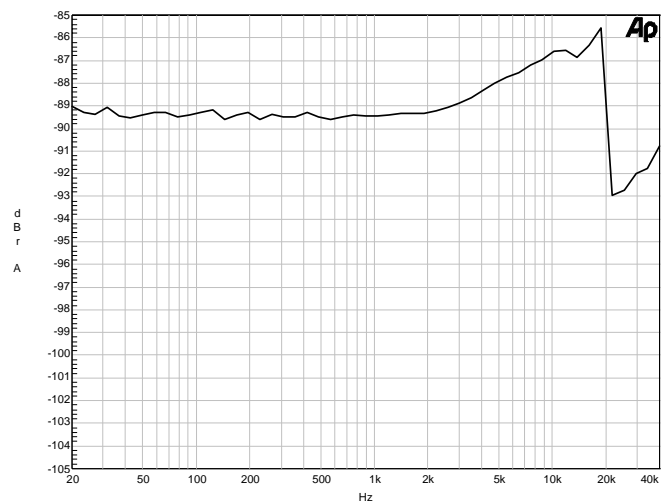

Figure 44. THDN vs Freq, HRM, VA = 5V

8. PARAMETER DEFINITIONS

Total Harmonic Distortion + Noise (THD+N)

A measure of crosstalk between the left and right channels. Measured for each channel at the converter's output with all zeros to the input under test and a full-scale signal applied to the other channel. Units in decibels.

Dynamic Range

The ratio of the full scale rms value of the signal to the rms sum of all other spectral components over the specified bandwidth. Dynamic range is a signal-to-noise measurement over the specified bandwidth made with a -60 dBFS signal. 60 dB is then added to the resulting measurement to refer the measurement to full scale. This technique ensures that the distortion components are below the noise level and do not effect the measurement. This measurement technique has been accepted by the Audio Engineering Society, AES17-1991, and the Electronic Industries Association of Japan, EIAJ CP-307.

Interchannel Isolation

A measure of crosstalk between the left and right channels. Measured for each channel at the converter's output with all zeros to the input under test and a full-scale signal applied to the other channel. Units in decibels.

Interchannel Gain Mismatch

The gain difference between left and right channels. Units in decibels.

Gain Error

The deviation from the nominal full scale analog output for a full scale digital input.

Gain Drift

The change in gain value with temperature. Units in ppm/°C.

9. REFERENCES

- 1) "How to Achieve Optimum Performance from Delta-Sigma A/D & D/A Converters" by Steven Harris. Paper presented at the 93rd Convention of the Audio Engineering Society, October 1992.
- 2) CDB4340 Evaluation Board Datasheet

10. PACKAGE DIMENSIONS

16L SOIC (150 MIL BODY) PACKAGE DRAWING

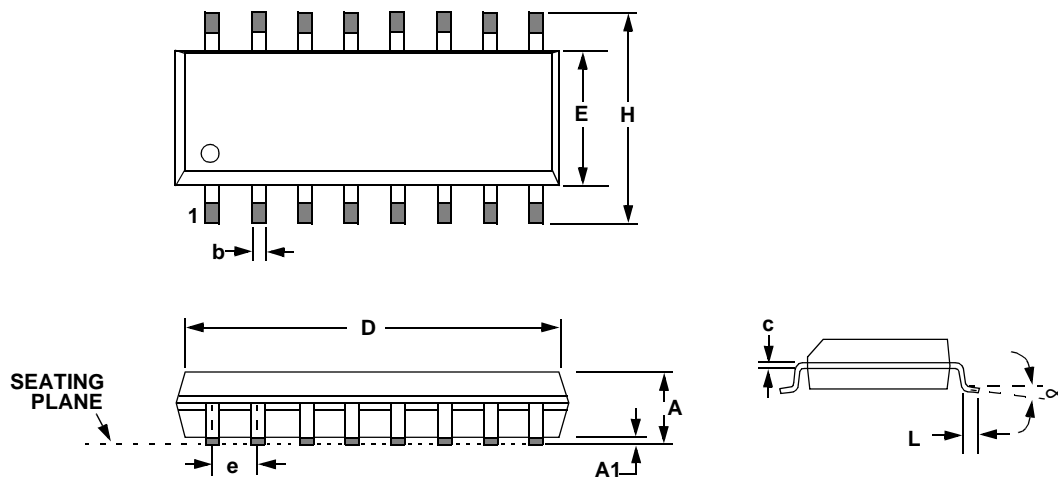

DIM	INCHES			MILLIMETERS		
	MIN	NOM	MAX	MIN	NOM	MAX
A	0.053	0.064	0.069	1.35	1.63	1.75
A1	0.004	0.006	0.010	0.10	0.15	0.25
b	0.013	0.016	0.020	0.33	0.41	0.51
C	0.0075	0.008	0.010	0.19	0.20	0.25
D	0.386	0.390	0.394	9.80	9.91	10.00
E	0.150	0.154	0.157	3.80	3.90	4.00
e	0.040	0.050	0.060	1.02	1.27	1.52
H	0.228	0.236	0.244	5.80	6.0	6.20
L	0.016	0.025	0.050	0.40	0.64	1.27
∞	0°	4°	8°	0°	4°	8°

JEDEC #: MS-012

Controlling Dimension is Millimeters

SMART
Analog™