

3-V TO 6-V INPUT, 3-A OUTPUT TRACKING SYNCHRONOUS BUCK PWM SWITCHER WITH INTEGRATED FETs (SWIFT™) FOR SEQUENCING

FEATURES

- Power-Up/Down Tracking for Sequencing
- 60-mΩ MOSFET Switches for High Efficiency at 3-A Continuous Output Source or Sink Current
- Wide PWM Frequency: Fixed 350 kHz or Adjustable 280 kHz to 700 kHz
- Power Good and Enable
- Load Protected by Peak Current Limit and Thermal Shutdown
- Integrated Solution Reduces Board Area and Component Count

APPLICATIONS

- Low-Voltage, High-Density Distributed Power Systems
- Point of Load Regulation for High-Performance DSPs, FPGAs, ASICs, and Microprocessors Requiring Sequencing
- Broadband, Networking, and Optical Communications Infrastructure

DESCRIPTION

As a member of the SWIFT™ family of dc/dc regulators, the TPS54380 low-input voltage, high-output current, synchronous buck PWM converter integrates all required active components. Using the TRACKIN pin with other regulators, simultaneous power up and down are easily implemented. Included on the substrate with the listed features are a true, high-performance, voltage error amplifier that enables maximum performance and flexibility in choosing the output filter L and C components; an undervoltage-lockout circuit to prevent start-up until the input voltage reaches 3 V; an internally or externally set slow-start circuit to limit inrush currents; and a power-good output useful for processor/logic reset.

The TPS54380 is available in a thermally enhanced 20-pin TSSOP (PWP) PowerPAD™ package, which eliminates bulky heatsinks. TI provides evaluation modules and the SWIFT™ designer software tool to aid in quickly achieving high-performance power supply designs to meet aggressive equipment development cycles.

SIMPLIFIED SCHEMATIC

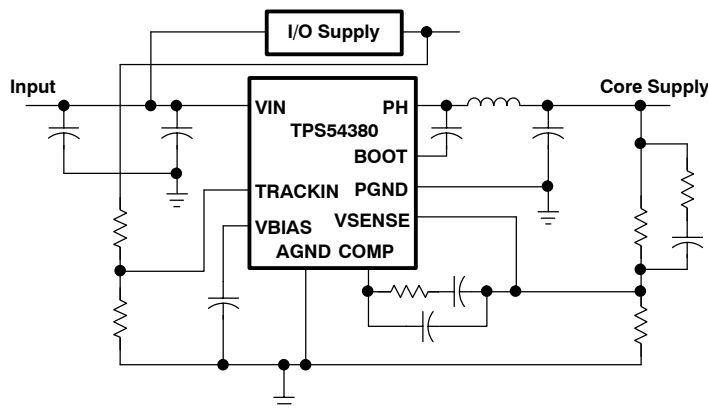

START-UP WAVEFORM

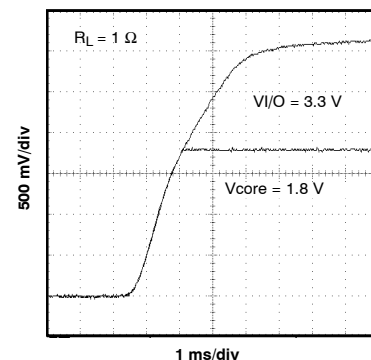

Please be aware that an important notice concerning availability, standard warranty, and use in critical applications of Texas Instruments semiconductor products and disclaimers thereto appears at the end of this data sheet.

PowerPAD and SWIFT are trademarks of Texas Instruments.

TPS54380

SLVS454B – JANUARY 2003 – REVISED FEBRUARY 2005



These devices have limited built-in ESD protection. The leads should be shorted together or the device placed in conductive foam during storage or handling to prevent electrostatic damage to the MOS gates.

ORDERING INFORMATION

T _A	OUTPUT VOLTAGE	PACKAGE	PART NUMBER
-40°C to 85°C	0.9 V to 3.3 V	Plastic HTSSOP (PWP) ⁽¹⁾	TPS54380PWP

(1) The PWP package is also available taped and reeled. Add an R suffix to the device type (i.e., TPS54380PWPR). See the application section of the data sheet for PowerPAD drawing and layout information.

(2) For the most current package and ordering information, see the Package Option Addendum at the end of this document, or see the TI website at www.ti.com.

ABSOLUTE MAXIMUM RATINGS

over operating free-air temperature range unless otherwise noted⁽¹⁾

		TPS54380	UNIT
Input voltage range, V _I	VIN, ENA	-0.3 to 7	V
	RT	-0.3 to 6	
	VSENSE, TRACKIN	-0.3 to 4	
	BOOT	-0.3 to 17	
Output voltage range, V _O	VBIAS, COMP, PWRGD	-0.3 to 7	V
	PH	-0.6 to 10	
Source current, I _O	PH	Internally Limited	
	COMP, VBIAS	6	mA
Sink current, I _S	PH	6	A
	COMP	6	mA
	ENA, PWRGD	10	
Voltage differential	AGND to PGND	±0.3	V
Operating virtual junction temperature range, T _J		-40 to 125	°C
Storage temperature, T _{stg}		-65 to 150	°C
Lead temperature 1,6 mm (1/16 inch) from case for 10 seconds		300	°C

(1) Stresses beyond those listed under “absolute maximum ratings” may cause permanent damage to the device. These are stress ratings only, and functional operation of the device at these or any other conditions beyond those indicated under “recommended operating conditions” is not implied. Exposure to absolute-maximum-rated conditions for extended periods may affect device reliability.

RECOMMENDED OPERATING CONDITIONS

	MIN	NOM	MAX	UNIT
Input voltage, V _I	3		6	V
Operating junction temperature, T _J	-40		125	°C

DISSIPATION RATINGS⁽¹⁾⁽²⁾

PACKAGE	THERMAL IMPEDANCE JUNCTION-TO-AMBIENT	T _A = 25°C POWER RATING	T _A = 70°C POWER RATING	T _A = 85°C POWER RATING
20-Pin PWP with solder	26 °C/W	3.85 W ⁽³⁾	2.12 W	1.54 W
20-Pin PWP without solder	57.5 °C/W	1.73 W	0.96 W	0.69 W

(1) For more information on the PWP package, see TI technical brief, literature number SLMA002.

(2) Test board conditions:

- 3-inch x 3-inch, 2 layers, thickness: 0.062 inch
- 1.5-oz. copper traces located on the top of the PCB
- 1.5-oz. copper ground plane on the bottom of the PCB
- 10 thermal vias (see “Recommended Land Pattern” in applications section of this data sheet)

(3) Maximum power dissipation may be limited by overcurrent protection.

ELECTRICAL CHARACTERISTICS

over operating free-air temperature range unless otherwise noted

PARAMETER		TEST CONDITIONS	MIN	TYP	MAX	UNIT
SUPPLY VOLTAGE, VIN						
Input voltage range, VIN			3.0		6.0	V
I _(Q)	Quiescent current	f _s = 350 kHz, RT open, PH pin open		6.2	9.6	mA
		f _s = 500 kHz, RT = 100 kΩ, PH pin open		8.4	12.8	
		Shutdown, ENA = 0 V		1	1.4	
UNDERVOLTAGE LOCKOUT						
Start threshold voltage, UVLO				2.95	3.0	V
Stop threshold voltage, UVLO			2.70	2.80		V
Hysteresis voltage, UVLO			0.14	0.16		V
Rising and falling edge deglitch, UVLO ⁽¹⁾				2.5		μs
BIAS VOLTAGE						
Output voltage, VBIAS		I _(VBIAS) = 0	2.70	2.80	2.90	V
Output current, VBIAS ⁽²⁾					100	μA
CUMULATIVE REFERENCE						
V _{ref}	Accuracy		0.882	0.891	0.900	V
REGULATION						
Line regulation ⁽¹⁾⁽³⁾		I _L = 1.5 A, f _s = 350 kHz, T _J = 85°C			0.07	%V
		I _L = 1.5 A, f _s = 550 kHz, T _J = 85°C			0.07	
Load regulation ⁽¹⁾⁽³⁾		I _L = 0 A to 3 A, f _s = 350 kHz, T _J = 85°C			0.03	%A
		I _L = 0 A to 3 A, f _s = 550 kHz, T _J = 85°C			0.03	
OSCILLATOR						
Internally set—free running frequency		RT open	280	350	420	kHz
Externally set—free running frequency range		RT = 180 kΩ (1% resistor to AGND) ⁽¹⁾	252	280	308	kHz
		RT = 100 kΩ (1% resistor to AGND)	460	500	540	
		RT = 68 kΩ (1% resistor to AGND) ⁽¹⁾	663	700	762	
Ramp valley ⁽¹⁾				0.75		V
Ramp amplitude (peak-to-peak) ⁽¹⁾				1		V
Minimum controllable on time ⁽¹⁾					200	ns
Maximum duty cycle			90%			

⁽¹⁾ Specified by design

⁽²⁾ Static resistive loads only

⁽³⁾ Specified by the circuit used in Figure 10

TPS54380

SLVS454B – JANUARY 2003 – REVISED FEBRUARY 2005

ELECTRICAL CHARACTERISTICS (continued)

over operating free-air temperature range unless otherwise noted

PARAMETER	TEST CONDITIONS	MIN	TYP	MAX	UNIT
ERROR AMPLIFIER					
Error amplifier open-loop voltage gain	1 k Ω COMP to AGND ⁽¹⁾	90	110		dB
Error amplifier unity gain bandwidth	Parallel 10 k Ω , 160 pF COMP to AGND ⁽¹⁾	3	5		MHz
Error amplifier common mode input voltage range	Powered by internal LDO ⁽¹⁾	0		VBIAS	V
Input bias current, VSENSE	VSENSE = V _{ref}		60	250	nA
Output voltage slew rate (symmetric), COMP ⁽¹⁾		1.0	1.4		V/ μ s
PWM COMPARATOR					
PWM comparator propagation delay time, PWM comparator input to PH pin (excluding dead-time)	10-mV overdrive ⁽¹⁾		70	85	ns
ENABLE					
Enable threshold voltage, ENA		0.82	1.20	1.40	V
Enable hysteresis voltage, ENA			0.03		V
Falling edge deglitch, ENA ⁽¹⁾			2.5		μ s
Leakage current, ENA	V _I = 5.5 V			1	μ A
POWER GOOD					
Power-good threshold voltage	VSENSE falling		90		%V _{ref}
Power-good hysteresis voltage ⁽¹⁾			3		%V _{ref}
Power-good falling edge deglitch ⁽¹⁾			35		μ s
Output saturation voltage, PWRGD	I _(sink) = 2.5 mA		0.18	0.3	V
Leakage current, PWRGD	V _I = 5.5 V			1	μ A
CURRENT LIMIT					
Current limit trip point	V _I = 3 V Output shorted ⁽¹⁾	4	6.5		A
	V _I = 6 V Output shorted ⁽¹⁾	4.5	7.5		
Current limit leading edge blanking time ⁽¹⁾			100		ns
Current limit total response time ⁽¹⁾			200		ns
THERMAL SHUTDOWN					
Thermal shutdown trip point ⁽¹⁾		135	150	165	$^{\circ}$ C
Thermal shutdown hysteresis ⁽¹⁾			10		$^{\circ}$ C
OUTPUT POWER MOSFETS					
r _{DS(on)} Power MOSFET switches	V _I = 6 V ⁽⁴⁾		59	88	m Ω
	V _I = 3 V ⁽⁴⁾		85	136	
TRACKIN					
Input offset, TRACKIN	V _{SENSE} = TRACKIN = 1.25 V ⁽¹⁾	-1.5		1.5	mV
Input voltage range, TRACKIN	See Note 1	0		V _{ref}	V

⁽¹⁾ Specified by design

⁽²⁾ Static resistive loads only

⁽³⁾ Specified by the circuit used in Figure 10

⁽⁴⁾ Matched MOSFETs low-side r_{DS(on)} production tested, high-side r_{DS(on)} specified by design

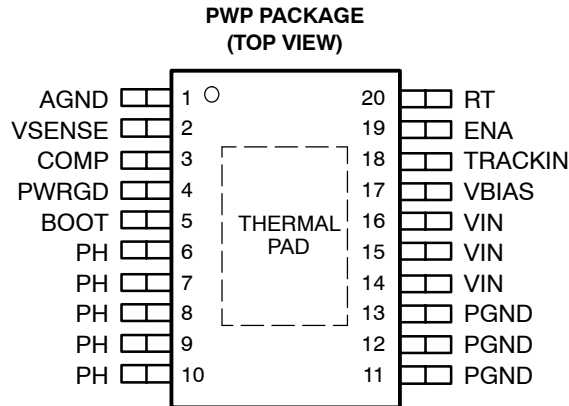

TERMINAL FUNCTIONS

TERMINAL NAME	NO.	DESCRIPTION
AGND	1	Analog ground. Return for compensation network/output divider, slow-start capacitor, VBIAS capacitor, RT resistor. Connect PowerPAD to AGND.
BOOT	5	Bootstrap output. 0.022- μ F to 0.1- μ F low-ESR capacitor connected from BOOT to PH generates floating drive for the high-side FET driver.
COMP	3	Error amplifier output. Connect frequency compensation network from COMP to VSENSE
ENA	19	Enable input. Logic high enables oscillator, PWM control and MOSFET driver circuits. Logic low disables operation and places device in low quiescent current state.
PGND	11–13	Power ground. High current return for the low-side driver and power MOSFET. Connect PGND with large copper areas to the input and output supply returns, and negative terminals of the input and output capacitors. A single-point connection to AGND is recommended.
PH	6–10	Phase output. Junction of the internal high-side and low-side power MOSFETs and output inductor.
PWRGD	4	Power-good open-drain output. High when VSENSE \geq 90% V_{ref} , otherwise PWRGD is low.
RT	20	Frequency setting resistor input. Connect a resistor from RT to AGND to set the switching frequency.
TRACKIN	18	External reference input. High impedance input to internal reference/multiplexer and error amplifier circuits.
VBIAS	17	Internal bias regulator output. Supplies regulated voltage to internal circuitry. Bypass VBIAS pin to AGND pin with a high quality, low-ESR 0.1- μ F to 1.0- μ F ceramic capacitor.
VIN	14–16	Input supply for the power MOSFET switches and internal bias regulator. Bypass VIN pins to PGND pins close to device package with a high quality, low-ESR 10- μ F ceramic capacitor.
VSENSE	2	Error amplifier inverting input. Connect to output voltage through compensation network/output divider.

TPS54380

SLVS454B – JANUARY 2003 – REVISED FEBRUARY 2005

INTERNAL BLOCK DIAGRAM

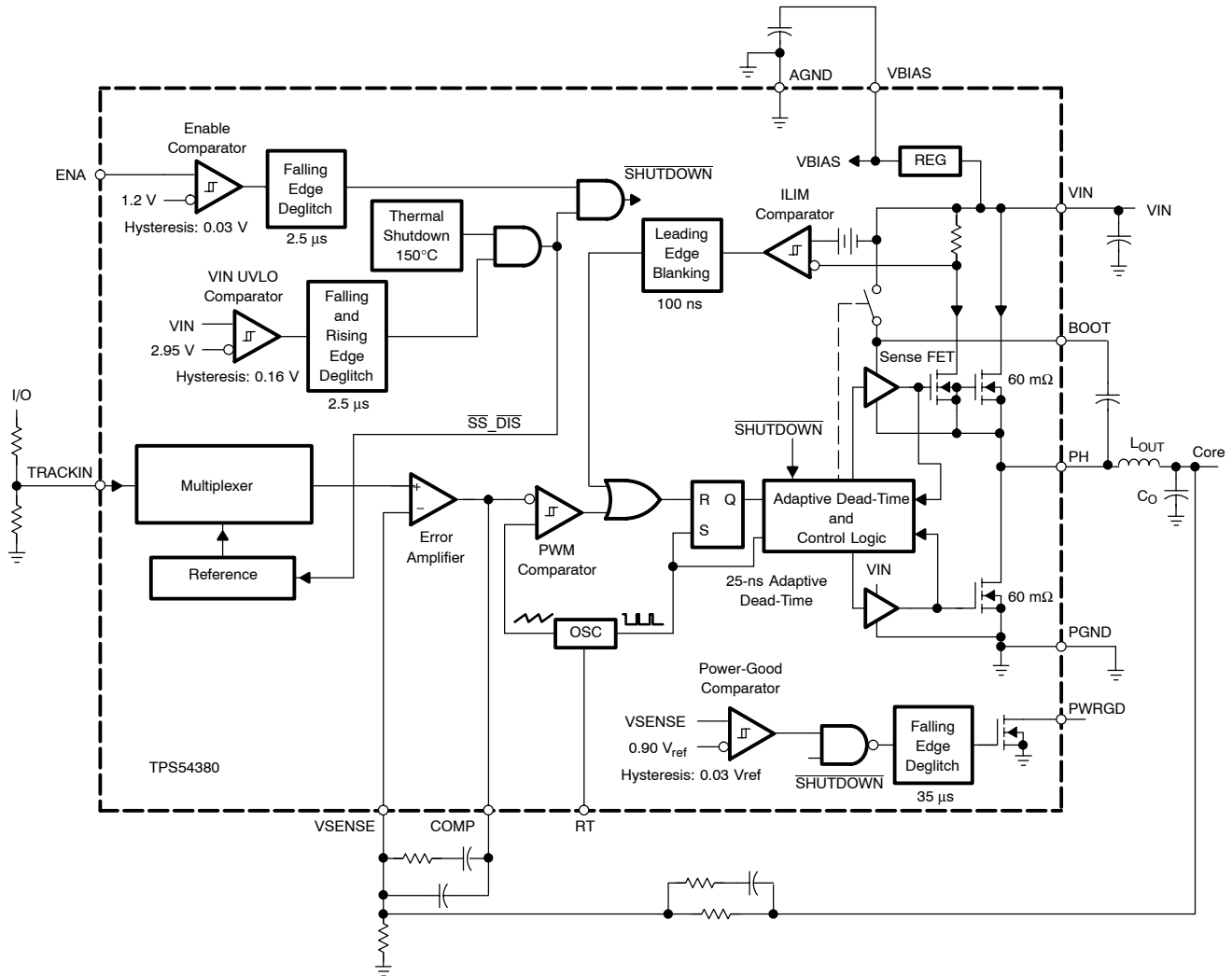

TYPICAL CHARACTERISTICS

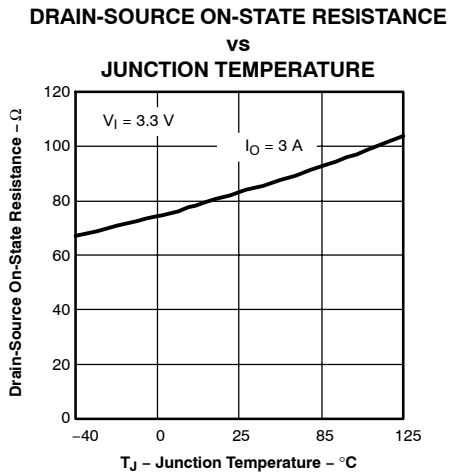

Figure 1

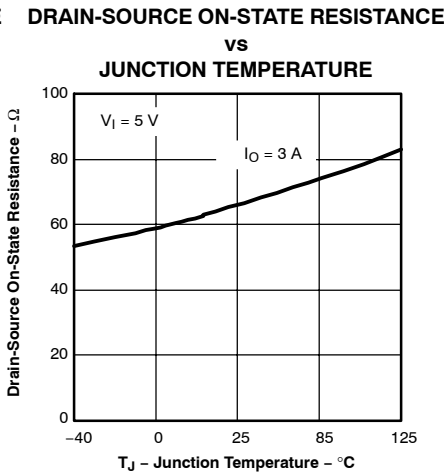

Figure 2

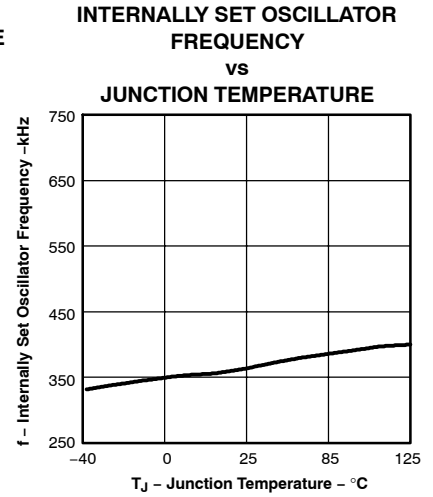

Figure 3

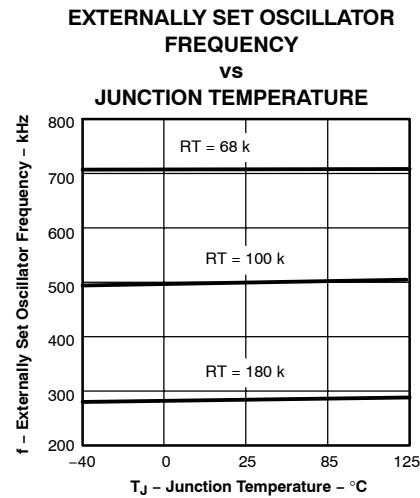

Figure 4

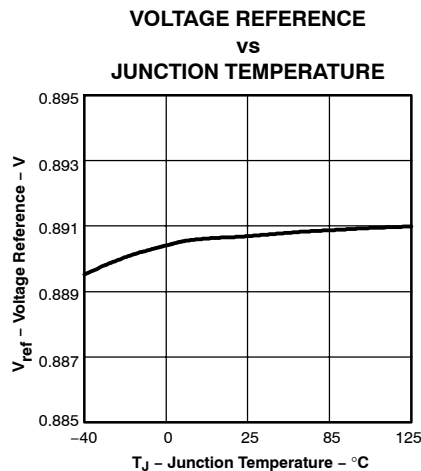

Figure 5

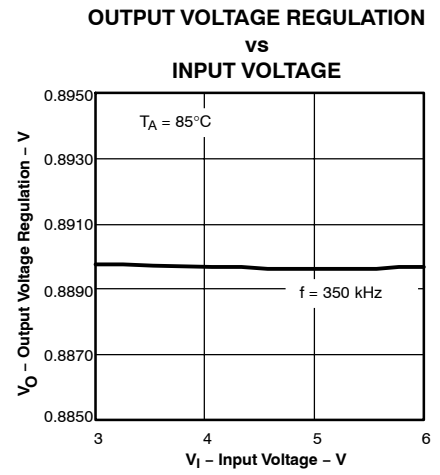

Figure 6

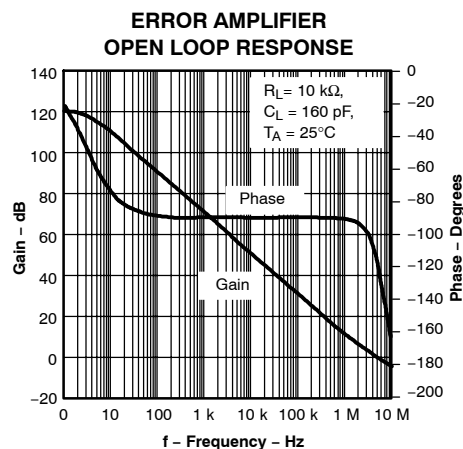

Figure 7

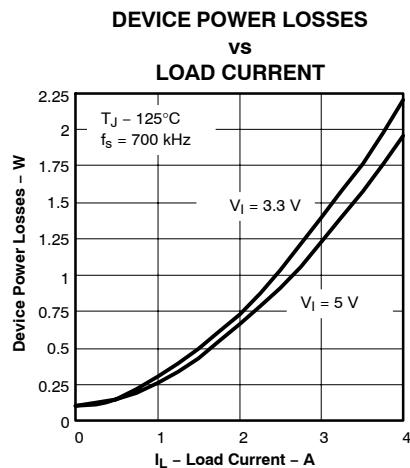
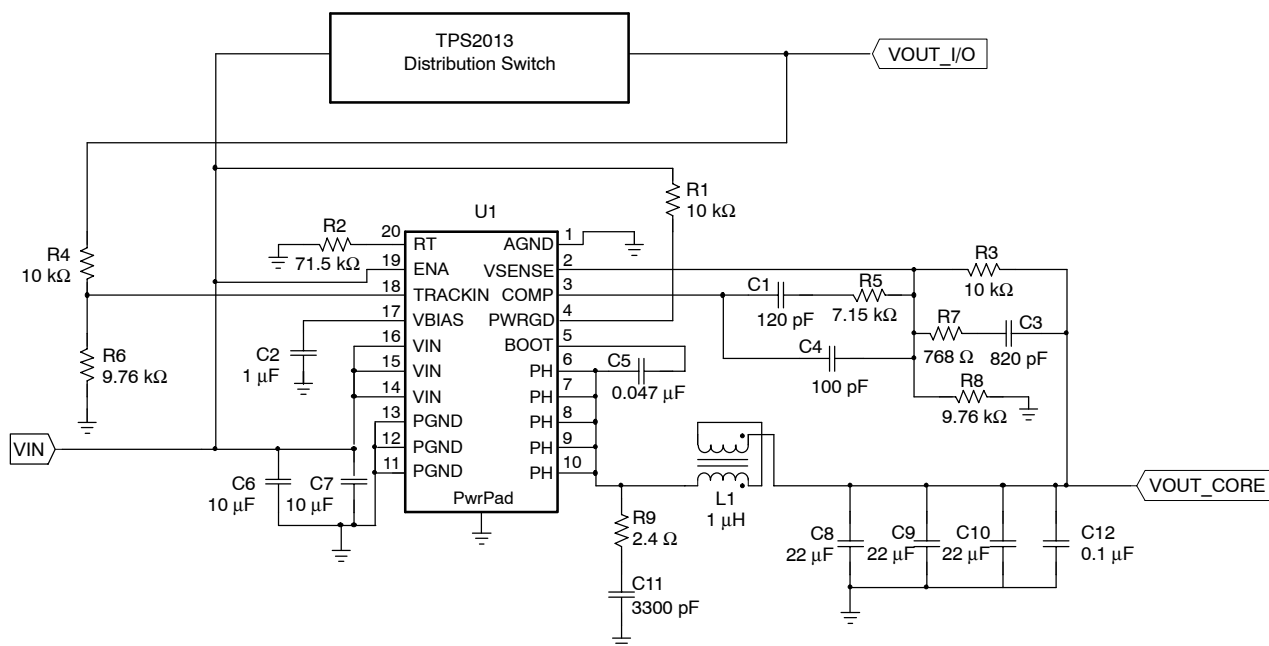

Figure 8

APPLICATION INFORMATION

Figure 9 shows the schematic diagram for a typical TPS54380 application. The TPS54380 (U1) can provide greater than 3 A of output current at a nominal output voltage of 1.8 V. For proper thermal performance, the exposed thermal PowerPAD underneath the integrated circuit package must be soldered to the printed-circuit

board. To provide power-up tracking, the enable of the I/O supply should be used. If the I/O enable is not used to power up, then devices with similar undervoltage lockout thresholds need to be implemented to ensure power-up tracking. To ensure power-down tracking, the enable pin must be used.



Analog and Power Grounds are Tied at the PowerPAD Under the Package of IC

Figure 9. Application Circuit

COMPONENT SELECTION

The values for the components used in this design example were selected for low output ripple voltage and small PCB area. Additional design information is available at www.ti.com.

INPUT FILTER

The input voltage is a nominal 5 Vdc. The input filter C6 is a 10-μF ceramic capacitor (Taiyo Yuden). C7, also a 10-μF ceramic capacitor (Taiyo Yuden), provides high-frequency decoupling of the TPS54380 from the input supply and must be located as close as possible to the device. Ripple current is carried in both C6 and C7, and the return path to PGND must avoid the current circulating in the output capacitors C8, C9, and C10.

FEEDBACK CIRCUIT

The values for these components have been selected to provide low output ripple voltage. The resistor divider network of R3 and R8 sets the output voltage for the circuit

at 1.8 V. R3, along with R7, R5, C1, C3, and C4 form the loop compensation network for the circuit. For this design, a Type 3 topology is used.

OPERATING FREQUENCY

In the application circuit, the 350-kHz operation is selected by leaving RT open. Connecting a 180-kΩ to 68-kΩ resistor between RT (pin 20) and analog ground can be used to set the switching frequency from 280 kHz to 700 kHz. To calculate the RT resistor, use the following equation:

$$R = \frac{500 \text{ kHz}}{\text{Switching Frequency}} \times 100 \text{ [k}\Omega\text{]} \quad (1)$$

OUTPUT FILTER

The output filter is composed of a 1-μH inductor and 3 x 22-μF capacitor. The inductor is a low dc resistance (0.010 Ω) type, Vishay 1HLP2525CZ01. The capacitors used are 22-μF, 6.3-V ceramic types with X5R dielectric.

An additional high-frequency bypass capacitor, C12, is also used. The feedback loop is compensated so that the unity gain frequency is approximately 50 kHz.

PCB LAYOUT

Figure 10 shows a generalized PCB layout guide for the TPS54380.

The VIN pins should be connected together on the printed-circuit board (PCB) and bypassed with a low-ESR ceramic bypass capacitor. Care should be taken to minimize the loop area formed by the bypass capacitor connections, the VIN pins, and the TPS54380 ground pins. The minimum recommended bypass capacitance is 10 μ F ceramic with a X5R or X7R dielectric and the optimum placement is closest to the VIN pins and the PGND pins.

The TPS54380 has two internal grounds (analog and power). Inside the TPS54380, the analog ground ties to all of the noise-sensitive signals, while the power ground ties to the noisier power signals. Noise injected between the two grounds can degrade the performance of the TPS54380, particularly at higher output currents. Ground noise on an analog ground plane can also cause problems with some of the control and bias signals. For these reasons, separate analog and power ground traces are recommended. There should be an area of ground on the top layer directly under the IC, with an exposed area for connection to the PowerPAD. Use vias to connect this ground area to any internal ground planes. Use additional vias at the ground side of the input and output filter capacitors as well. The AGND and PGND pins should be tied to the PCB ground by connecting them to the ground area under the device as shown. The only components that should tie directly to the power ground plane are the input capacitors, the output capacitors, the input voltage decoupling capacitor, and the PGND pins of the TPS54380. Use a separate wide trace for the analog ground signal path. This analog ground should be used for the voltage set-point divider, timing resistor RT, and bias capacitor grounds. Connect this trace directly to AGND (pin 1).

The PH pins should be tied together and routed to the output inductor. Because the PH connection is the switching node, inductor should be located close to the PH pins and the area of the PCB conductor minimized to prevent excessive capacitive coupling.

Connect the boot capacitor between the phase node and the BOOT pin as shown. Keep the boot capacitor close to the IC and minimize the conductor trace lengths.

Connect the output filter capacitor(s) as shown, between the VOUT trace and PGND. It is important to keep the loop formed by the PH pins, Lout, Cout, and PGND as small as practical.

Place the compensation components from the VOUT trace to the VSENSE and COMP pins. Do not place these components too close to the PH trace. Due to the size of the IC package and the device pinout, they have to be routed somewhat close, but maintain as much separation as possible while still keeping the layout compact.

Connect the bias capacitor from the VBIAS pin to analog ground using the isolated analog ground trace. If an RT resistor is used, connect it to this trace as well.

LAYOUT CONSIDERATIONS FOR THERMAL PERFORMANCE

For operation at full rated load current, the analog ground plane must provide an adequate heat dissipating area. A 3-inch by 3-inch plane of 1-ounce copper is recommended, though not mandatory, depending on ambient temperature and airflow. Most applications have larger areas of internal ground plane available, and the PowerPAD must be connected to the largest area available. Additional areas on the top or bottom layers also help dissipate heat, and any area available must be used when 3-A or greater operation is desired. Connection from the exposed area of the PowerPAD to the analog ground plane layer must be made using 0.013-inch diameter vias to avoid solder wicking through the vias. Six vias must be in the PowerPAD area with four additional vias located under the device package. The size of the vias under the package, but not in the exposed thermal pad area, can be increased to 0.018. Additional vias beyond the twelve recommended that enhance thermal performance must be included in areas not under the device package.

TPS54380

SLVS454B – JANUARY 2003 – REVISED FEBRUARY 2005

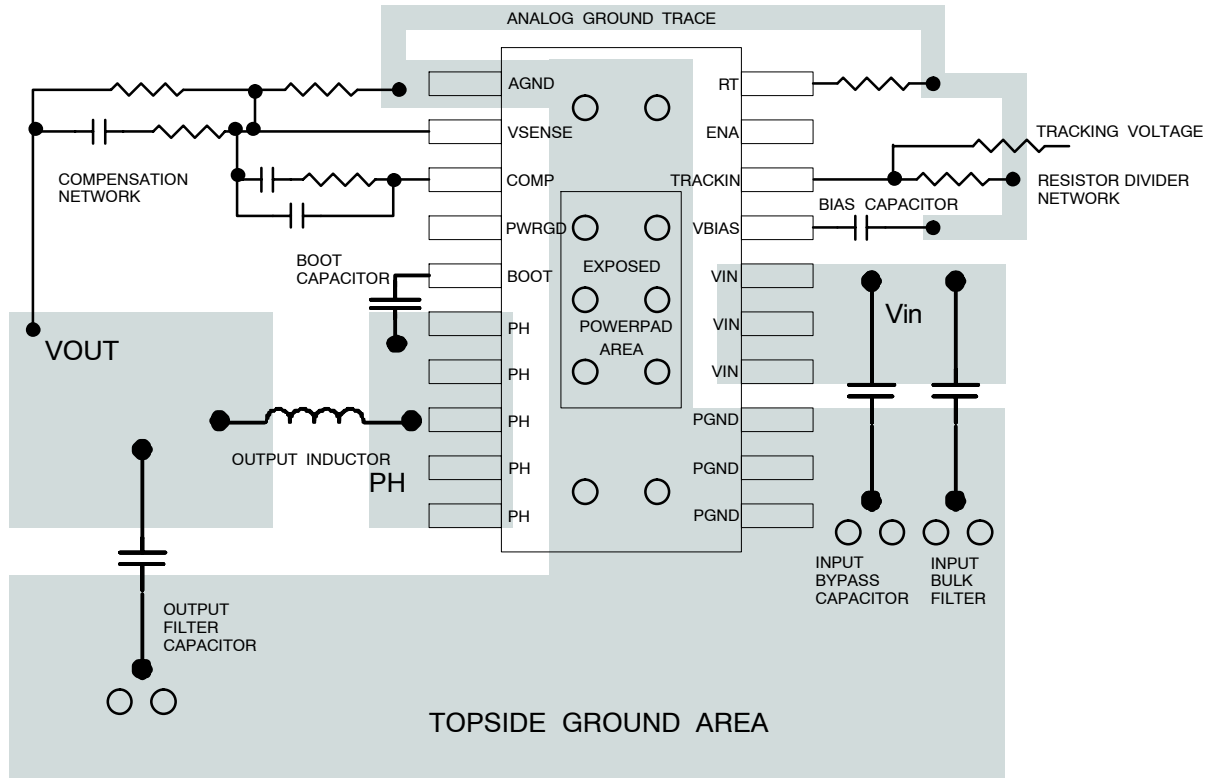

Figure 10. TPS54380 PCB Layout

PERFORMANCE GRAPHS

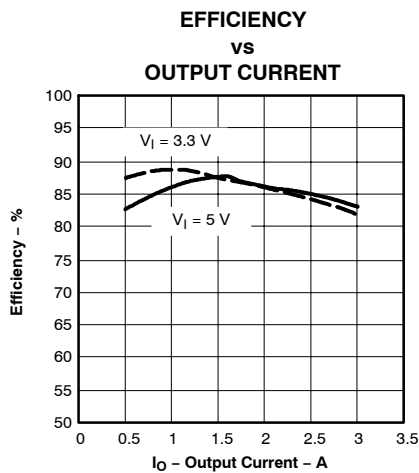

Figure 11

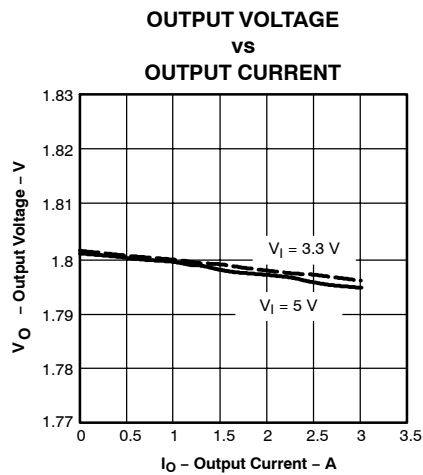

Figure 12

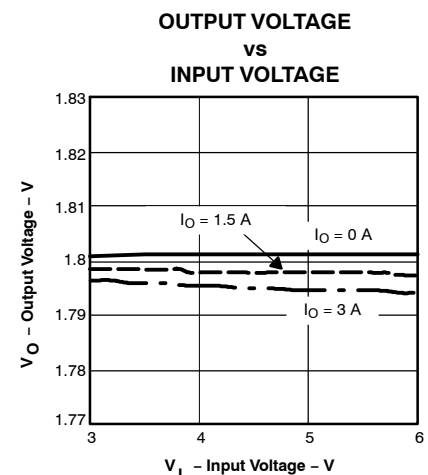

Figure 13

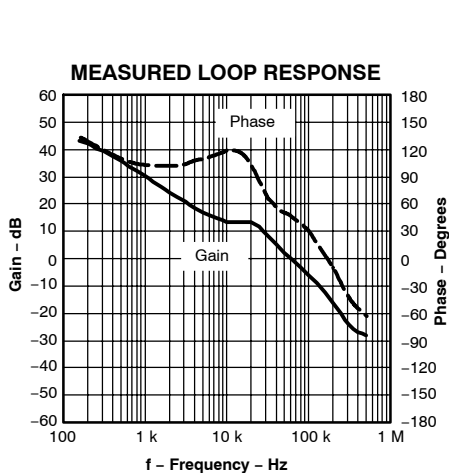

Figure 14

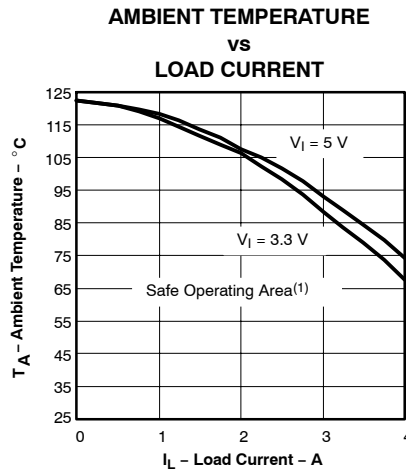

Figure 15

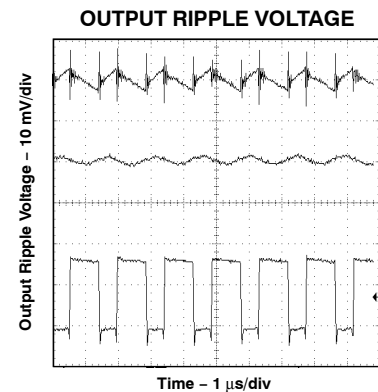

Figure 16

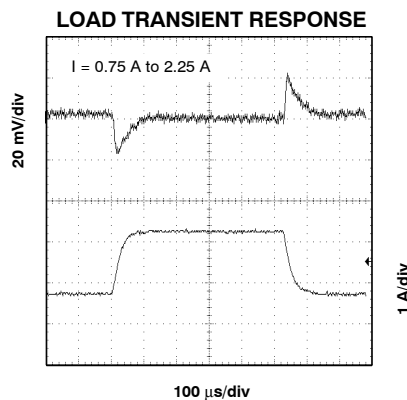

Figure 17

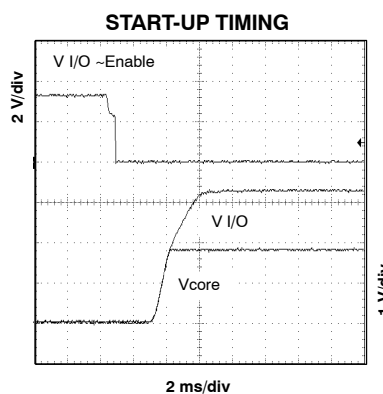

Figure 18

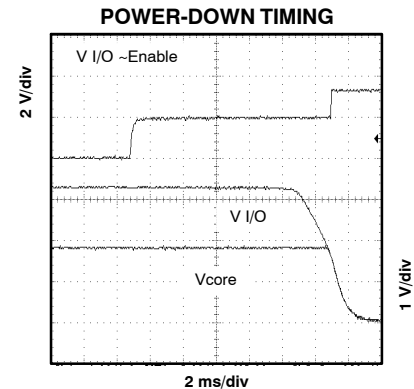

Figure 19

(1) Safe operating area is applicable to the test board conditions in the Dissipation Ratings table.

DETAILED DESCRIPTION

UNDERVOLTAGE LOCKOUT (UVLO)

The TPS54380 incorporates an undervoltage lockout circuit to keep the device disabled when the input voltage (VIN) is insufficient. During power up, internal circuits are held inactive until VIN exceeds the nominal UVLO threshold voltage of 2.95 V. Once the UVLO start threshold is reached, device start-up begins. The device operates until VIN falls below the nominal UVLO stop threshold of 2.8 V. Hysteresis in the UVLO comparator, and a 2.5- μ s rising and falling edge deglitch circuit reduce the likelihood of shutting the device down due to noise on VIN.

TRACKIN/INTERNAL SLOW-START

The internal slow-start circuit provides start-up slope control of the output voltage. The nominal internal slow-start rate is 25 V/ms. When the voltage on TRACKIN rises faster than the internal slope or is present when device operation is enabled, the output rises at the internal

rate. If the reference voltage on TRACKIN rises more slowly, then the output rises at about the same rate as TRACKIN.

Once the voltage on the TRACKIN pin is greater than the internal reference of 0.891 V, the multiplexer switches the noninverting node to the high-precision reference.

ENABLE (ENA)

The enable pin, ENA, provides a digital control enable or disable (shutdown) for the TPS54380. An input voltage of 1.4 V or greater ensures that the TPS54380 is enabled. An input of 0.82 V or less ensures that device operation is disabled. These are not standard logic thresholds, even though they are compatible with TTL outputs.

When ENA is low, the oscillator, slow-start, PWM control and MOSFET drivers are disabled and held in an initial state ready for device start-up. On an ENA transition from low to high, device start-up begins with the output starting from 0 V.

VBIAS REGULATOR (VBIAS)

The VBIAS regulator provides internal analog and digital blocks with a stable supply voltage over variations in junction temperature and input voltage. A high quality, low-ESR, ceramic bypass capacitor is required on the VBIAS pin. X7R- or X5R-grade dielectrics are recommended because their values are more stable over temperature. The bypass capacitor must be placed close to the VBIAS pin and returned to AGND.

External loading on VBIAS is allowed, with the caution that internal circuits require a minimum VBIAS of 2.70 V, and external loads on VBIAS with ac or digital switching noise may degrade performance. The VBIAS pin may be useful as a reference voltage for external circuits.

VOLTAGE REFERENCE

The voltage reference system produces a precise V_{ref} signal by scaling the output of a temperature stable bandgap circuit. During manufacture, the bandgap and scaling circuits are trimmed to produce 0.891 V at the output of the error amplifier, with the amplifier connected as a voltage follower. The trim procedure adds to the high-precision regulation of the TPS54380, because it cancels offset errors in the scale and error amplifier circuits.

OSCILLATOR AND PWM RAMP

The oscillator frequency is set internally to 350 kHz. If a different frequency of operation is required for the application, the oscillator frequency can be externally adjusted from 280 to 700 kHz by connecting a resistor between the RT pin and AGND. The switching frequency is approximated by the following equation, where R is the resistance from RT to AGND:

$$\text{Switching Frequency} = \frac{100 \text{ k}\Omega}{R} \times 500 \text{ [kHz]} \quad (2)$$

SWITCHING FREQUENCY	RT PIN
350 kHz, internally set	Float
Externally set 280 kHz to 700 kHz	R = 180 k Ω to 68 k Ω

ERROR AMPLIFIER

The high-performance, wide bandwidth, voltage error amplifier sets the TPS54380 apart from most dc/dc converters. The user is given the flexibility to use a wide range of output L and C filter components to suit the particular application needs. Type-2 or type-3 compensation can be employed using external compensation components.

PWM CONTROL

Signals from the error amplifier output, oscillator, and current limit circuit are processed by the PWM control logic. Referring to the internal block diagram, the control logic includes the PWM comparator, OR gate, PWM latch,

and portions of the adaptive dead-time and control logic block. During steady-state operation below the current limit threshold, the PWM comparator output and oscillator pulse train alternately reset and set the PWM latch. Once the PWM latch is reset, the low-side FET remains on for a minimum duration set by the oscillator pulse width. During this period, the PWM ramp discharges rapidly to its valley voltage. When the ramp begins to charge back up, the low-side FET turns off and high-side FET turns on. As the PWM ramp voltage exceeds the error amplifier output voltage, the PWM comparator resets the latch, thus turning off the high-side FET and turning on the low-side FET. The low-side FET remains on until the next oscillator pulse discharges the PWM ramp.

During transient conditions, the error amplifier output could be below the PWM ramp valley voltage or above the PWM peak voltage. If the error amplifier is high, the PWM latch is never reset, and the high-side FET remains on until the oscillator pulse signals the control logic to turn the high-side FET off and the low-side FET on. The device operates at its maximum duty cycle until the output voltage rises to the regulation set-point, setting VSENSE to approximately the same voltage as VREF. If the error amplifier output is low, the PWM latch is continually reset and the high-side FET does not turn on. The low-side FET remains on until the VSENSE voltage decreases to a range that allows the PWM comparator to change states. The TPS54380 is capable of sinking current continuously until the output reaches the regulation set-point.

If the current limit comparator trips for longer than 100 ns, the PWM latch resets before the PWM ramp exceeds the error amplifier output. The high-side FET turns off and low-side FET turns on to decrease the energy in the output inductor and consequently the output current. This process is repeated each cycle in which the current limit comparator is tripped.

DEAD-TIME CONTROL AND MOSFET DRIVERS

Adaptive dead-time control prevents shoot-through current from flowing in both N-channel power MOSFETs during the switching transitions by actively controlling the turnon times of the MOSFET drivers. The high-side driver does not turn on until the voltage at the gate of the low-side FET is below 2 V. While the low-side driver does not turn on until the voltage at the gate of the high-side MOSFET is below 2 V.

The high-side and low-side drivers are designed with 300-mA source and sink capability to quickly drive the power MOSFETs gates. The low-side driver is supplied from VIN, while the high-side drive is supplied from the BOOT pin. A bootstrap circuit uses an external BOOT capacitor and an internal 2.5- Ω bootstrap switch connected between the VIN and BOOT pins. The integrated bootstrap switch improves drive efficiency and reduces external component count.

OVERCURRENT PROTECTION

The cycle-by-cycle current limiting is achieved by sensing the current flowing through the high-side MOSFET and comparing this signal to a preset overcurrent threshold. The high-side MOSFET is turned off within 200 ns of reaching the current limit threshold. A 100-ns leading edge blanking circuit prevents the current limit from false tripping. Current limit detection occurs only when current flows from VIN to PH when sourcing current to the output filter. Load protection during current sink operation is provided by thermal shutdown.

THERMAL SHUTDOWN

The device uses the thermal shutdown to turn off the power MOSFETs and disable the controller if the junction temperature exceeds 150°C. The device is released from shutdown automatically when the junction temperature decreases to 10°C below the thermal shutdown trip-point, and starts up under control of the slow-start circuit.

Thermal shutdown provides protection when an overload condition is sustained for several milliseconds. With a persistent fault condition, the device cycles continuously; starting up by control of the soft-start circuit, heating up due to the fault condition, and then shutting down on reaching the thermal shutdown trip-point. This sequence repeats until the fault condition is removed.

POWERGOOD (PWRGD)

The power-good circuit monitors for under-voltage conditions on VSENSE. If the voltage on VSENSE is 10% below the reference voltage, the open-drain PWRGD output is pulled low. PWRGD is also pulled low if VIN is less than the UVLO threshold or ENA is low, or a thermal shutdown occurs. When $V_{IN} \geq UVLO$ threshold, $ENA \geq$ enable threshold, and $VSENSE > 90\%$ of V_{ref} , the open-drain output of the PWRGD pin is high. A hysteresis voltage equal to 3% of V_{ref} and a 35- μ s falling edge deglitch circuit prevent tripping of the power-good comparator due to high-frequency noise.

THERMAL INFORMATION

This PowerPAD™ package incorporates an exposed thermal pad that is designed to be attached directly to an external heatsink. When the thermal pad is soldered directly to the printed circuit board (PCB), the PCB can be used as a heatsink. In addition, through the use of thermal vias, the thermal pad can be attached directly to a ground plane or special heatsink structure designed into the PCB. This design optimizes the heat transfer from the integrated circuit (IC).

For additional information on the PowerPAD package and how to take advantage of its heat dissipating abilities, refer to Technical Brief, PowerPAD Thermally Enhanced Package, Texas Instruments Literature No. SLMA002 and Application Brief, PowerPAD Made Easy, Texas Instruments Literature No. SLMA004. Both documents are available at www.ti.com.

The exposed thermal pad dimensions for this package are shown in the following illustration.

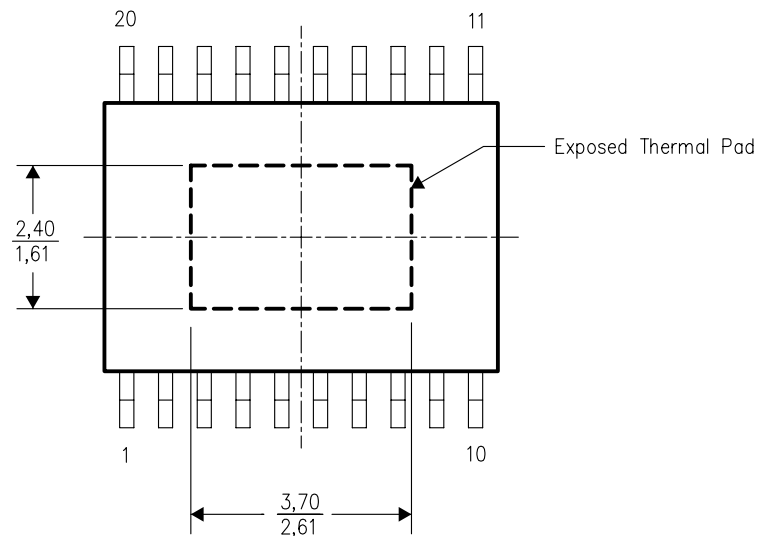

Top View

NOTE: All linear dimensions are in millimeters

Exposed Thermal Pad Dimensions

PACKAGING INFORMATION

Orderable Device	Status ⁽¹⁾	Package Type	Package Drawing	Pins	Package Qty	Eco Plan ⁽²⁾	Lead/Ball Finish	MSL Peak Temp ⁽³⁾
TPS54380PWP	ACTIVE	HTSSOP	PWP	20	70	Green (RoHS & no Sb/Br)	CU NIPDAU	Level-2-260C-1 YEAR
TPS54380PWPG4	ACTIVE	HTSSOP	PWP	20	70	Green (RoHS & no Sb/Br)	CU NIPDAU	Level-2-260C-1 YEAR
TPS54380PWPR	ACTIVE	HTSSOP	PWP	20	2000	Green (RoHS & no Sb/Br)	CU NIPDAU	Level-2-260C-1 YEAR
TPS54380PWPRG4	ACTIVE	HTSSOP	PWP	20	2000	Green (RoHS & no Sb/Br)	CU NIPDAU	Level-2-260C-1 YEAR

⁽¹⁾ The marketing status values are defined as follows:

ACTIVE: Product device recommended for new designs.

LIFEBUY: TI has announced that the device will be discontinued, and a lifetime-buy period is in effect.

NRND: Not recommended for new designs. Device is in production to support existing customers, but TI does not recommend using this part in a new design.

PREVIEW: Device has been announced but is not in production. Samples may or may not be available.

OBSOLETE: TI has discontinued the production of the device.

⁽²⁾ Eco Plan - The planned eco-friendly classification: Pb-Free (RoHS) or Green (RoHS & no Sb/Br) - please check <http://www.ti.com/productcontent> for the latest availability information and additional product content details.

TBD: The Pb-Free/Green conversion plan has not been defined.

Pb-Free (RoHS): TI's terms "Lead-Free" or "Pb-Free" mean semiconductor products that are compatible with the current RoHS requirements for all 6 substances, including the requirement that lead not exceed 0.1% by weight in homogeneous materials. Where designed to be soldered at high temperatures, TI Pb-Free products are suitable for use in specified lead-free processes.

Green (RoHS & no Sb/Br): TI defines "Green" to mean Pb-Free (RoHS compatible), and free of Bromine (Br) and Antimony (Sb) based flame retardants (Br or Sb do not exceed 0.1% by weight in homogeneous material)

⁽³⁾ MSL, Peak Temp. -- The Moisture Sensitivity Level rating according to the JEDEC industry standard classifications, and peak solder temperature.

Important Information and Disclaimer:The information provided on this page represents TI's knowledge and belief as of the date that it is provided. TI bases its knowledge and belief on information provided by third parties, and makes no representation or warranty as to the accuracy of such information. Efforts are underway to better integrate information from third parties. TI has taken and continues to take reasonable steps to provide representative and accurate information but may not have conducted destructive testing or chemical analysis on incoming materials and chemicals. TI and TI suppliers consider certain information to be proprietary, and thus CAS numbers and other limited information may not be available for release.

In no event shall TI's liability arising out of such information exceed the total purchase price of the TI part(s) at issue in this document sold by TI to Customer on an annual basis.

PWP (R-PDSO-G**) 20 PIN SHOWN

PowerPAD™ PLASTIC SMALL-OUTLINE PACKAGE

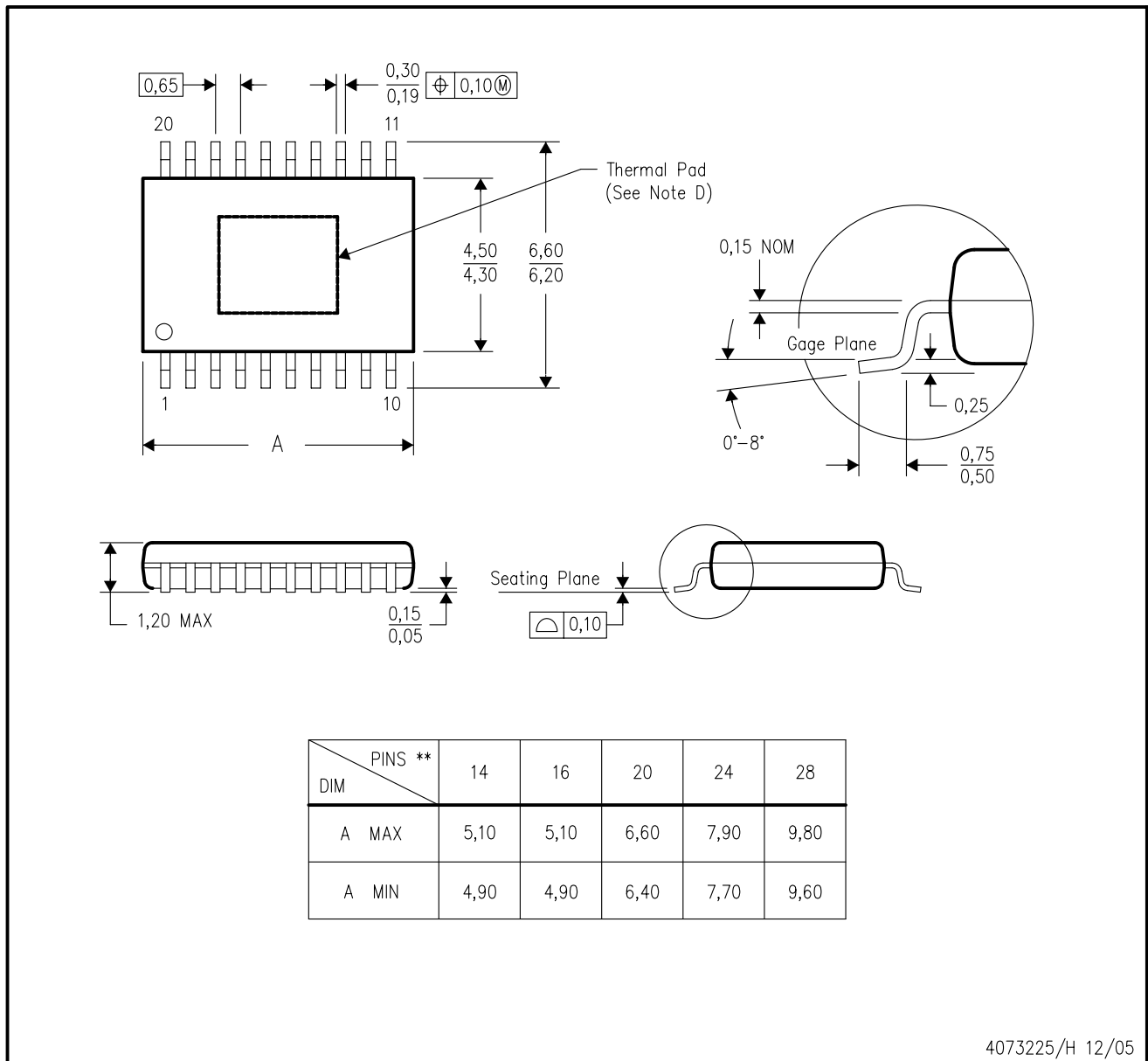

4073225/H 12/05

- NOTES:
- A. All linear dimensions are in millimeters.
 - B. This drawing is subject to change without notice.
 - C. Body dimensions do not include mold flash or protrusions. Mold flash and protrusion shall not exceed 0.15 per side.
 - D. This package is designed to be soldered to a thermal pad on the board. Refer to Technical Brief, PowerPad Thermally Enhanced Package, Texas Instruments Literature No. SLMA002 for information regarding recommended board layout. This document is available at www.ti.com <<http://www.ti.com>>.
 - E. Falls within JEDEC MO-153

PowerPAD is a trademark of Texas Instruments.

IMPORTANT NOTICE

Texas Instruments Incorporated and its subsidiaries (TI) reserve the right to make corrections, modifications, enhancements, improvements, and other changes to its products and services at any time and to discontinue any product or service without notice. Customers should obtain the latest relevant information before placing orders and should verify that such information is current and complete. All products are sold subject to TI's terms and conditions of sale supplied at the time of order acknowledgment.

TI warrants performance of its hardware products to the specifications applicable at the time of sale in accordance with TI's standard warranty. Testing and other quality control techniques are used to the extent TI deems necessary to support this warranty. Except where mandated by government requirements, testing of all parameters of each product is not necessarily performed.

TI assumes no liability for applications assistance or customer product design. Customers are responsible for their products and applications using TI components. To minimize the risks associated with customer products and applications, customers should provide adequate design and operating safeguards.

TI does not warrant or represent that any license, either express or implied, is granted under any TI patent right, copyright, mask work right, or other TI intellectual property right relating to any combination, machine, or process in which TI products or services are used. Information published by TI regarding third-party products or services does not constitute a license from TI to use such products or services or a warranty or endorsement thereof. Use of such information may require a license from a third party under the patents or other intellectual property of the third party, or a license from TI under the patents or other intellectual property of TI.

Reproduction of information in TI data books or data sheets is permissible only if reproduction is without alteration and is accompanied by all associated warranties, conditions, limitations, and notices. Reproduction of this information with alteration is an unfair and deceptive business practice. TI is not responsible or liable for such altered documentation.

Resale of TI products or services with statements different from or beyond the parameters stated by TI for that product or service voids all express and any implied warranties for the associated TI product or service and is an unfair and deceptive business practice. TI is not responsible or liable for any such statements.

Following are URLs where you can obtain information on other Texas Instruments products and application solutions:

Products		Applications	
Amplifiers	amplifier.ti.com	Audio	www.ti.com/audio
Data Converters	dataconverter.ti.com	Automotive	www.ti.com/automotive
DSP	dsp.ti.com	Broadband	www.ti.com/broadband
Interface	interface.ti.com	Digital Control	www.ti.com/digitalcontrol
Logic	logic.ti.com	Military	www.ti.com/military
Power Mgmt	power.ti.com	Optical Networking	www.ti.com/opticalnetwork
Microcontrollers	microcontroller.ti.com	Security	www.ti.com/security
		Telephony	www.ti.com/telephony
		Video & Imaging	www.ti.com/video
		Wireless	www.ti.com/wireless

Mailing Address: Texas Instruments
Post Office Box 655303 Dallas, Texas 75265