

TPS79015, TPS79018, TPS79025, TPS79028, TPS79030 ULTRALOW-POWER LOW-NOISE 50-mA LOW-DROPOUT LINEAR REGULATORS

SLVS299B – SEPTEMBER 2000 – REVISED MAY 2001

- 50-mA Low-Dropout Regulator
- Available in 1.5-V, 1.8-V, 2.5-V, 2.8-V, 3.0-V
- Output Noise Typically 56 μV_{RMS} (TPS79030)
- Only 17 μA Quiescent Current at 50 mA
- 1 μA Quiescent Current in Standby Mode
- Dropout Voltage Typically 57 mV at 50 mA (TPS79030)
- Over Current Limitation
- -40°C to 125°C Operating Junction Temperature Range
- 5-Pin SOT-23 (DBV) Package

description

The TPS790xx family of low-dropout (LDO) voltage regulators offers the benefits of low-dropout voltage, ultralow-power operation, low-output noise, and miniaturized packaging. These regulators feature low-dropout voltages and ultralow quiescent current compared to conventional LDO regulators. An internal resistor, in conjunction with an external bypass capacitor, creates a low-pass filter to reduce the noise. The TPS79030 exhibits only 56 μV_{RMS} of output voltage noise using 0.01 μF bypass and 10 μF output capacitors. Offered in a 5-terminal small outline integrated-circuit SOT-23 package, the TPS790xx series devices are ideal for micropower operations, low output noise, and where board space is limited.

The usual PNP pass transistor has been replaced by a PMOS pass element. Because the PMOS pass element behaves as a low-value resistor, the dropout voltage is very low, typically 57 mV at 50 mA of load current (TPS79030), and is directly proportional to the load current. The quiescent current is ultralow (17 μA typically) and is stable over the entire range of output load current (0 mA to 50 mA). Intended for use in portable systems such as laptops and cellular phones, the ultralow-dropout voltage feature and ultralow-power operation result in a significant increase in system battery operating life.

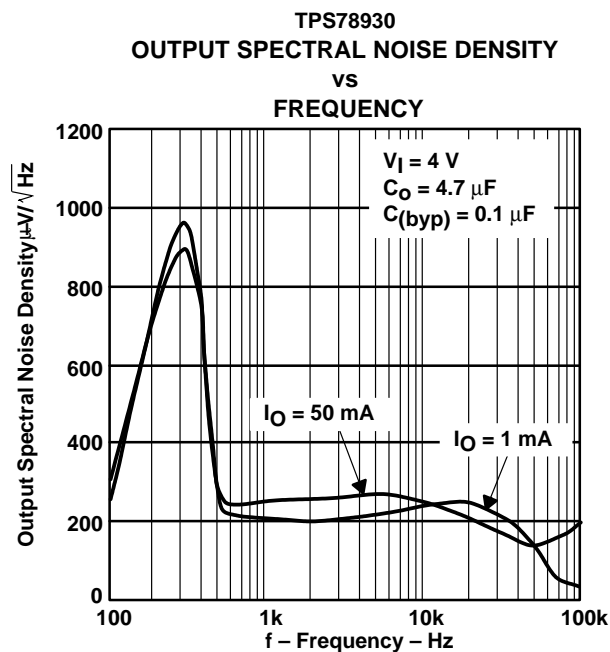
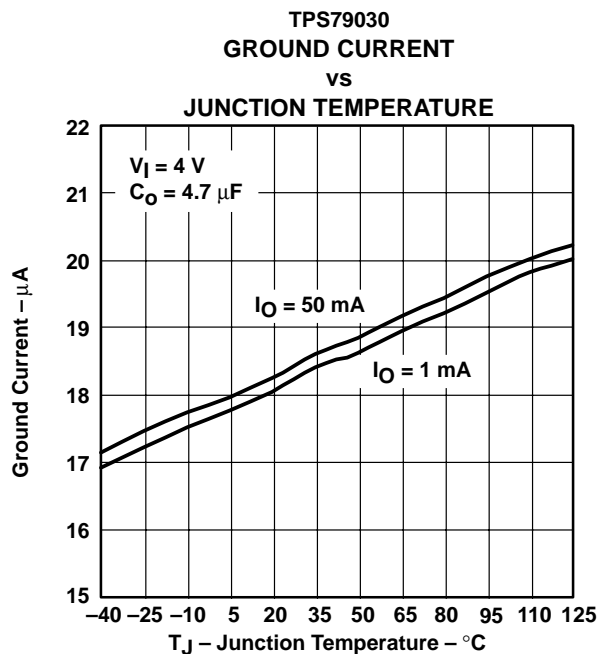
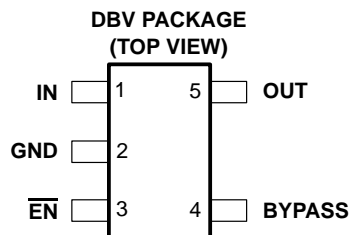

Please be aware that an important notice concerning availability, standard warranty, and use in critical applications of Texas Instruments semiconductor products and disclaimers thereto appears at the end of this data sheet.

PRODUCTION DATA information is current as of publication date. Products conform to specifications per the terms of Texas Instruments standard warranty. Production processing does not necessarily include testing of all parameters.

TEXAS
INSTRUMENTS

POST OFFICE BOX 655303 • DALLAS, TEXAS 75265

Copyright © 2001, Texas Instruments Incorporated

TPS79015, TPS79018, TPS79025, TPS79028, TPS79030 ULTRALOW-POWER LOW-NOISE 50-mA LOW-DROPOUT LINEAR REGULATORS

SLVS299B – SEPTEMBER 2000 – REVISED MAY 2001

description (continued)

The TPS790xx also features a logic-enabled sleep mode to shut down the regulator, reducing quiescent current to 1 μ A typical at $T_J = 25^\circ\text{C}$. The TPS790xx is offered in 1.5 V, 1.8 V, 2.5 V, 2.8 V, 3.0 V.

AVAILABLE OPTIONS

T_J	VOLTAGE	PACKAGE	PART NUMBER		SYMBOL
-40°C to 125°C	1.5 V	SOT-23 (DBV)	TPS79015DBVT†	TPS79015DBVR‡	PEBI
	1.8 V		TPS79018DBVT†	TPS79018DBVR‡	PECI
	2.5 V		TPS79025DBVT†	TPS79025DBVR‡	PEDI
	2.8 V		TPS79028DBVT†	TPS79028DBVR‡	PEEI
	3.0 V		TPS79030DBVT†	TPS79030DBVR‡	PEFI

† The DBVT indicates tape and reel of 250 parts.

‡ The DBVR indicates tape and reel of 3000 parts.

functional block diagram

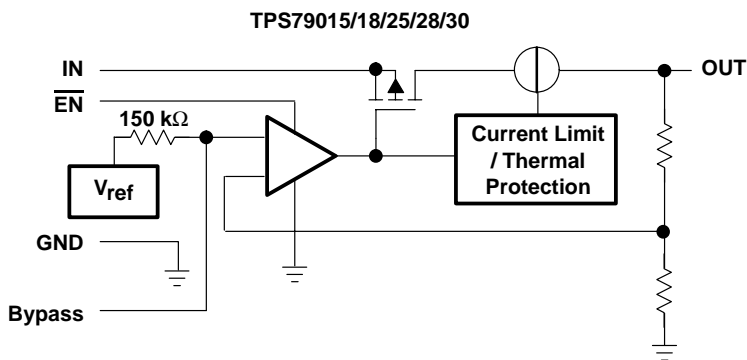

Terminal Functions

TERMINAL NAME	NO.	I/O	DESCRIPTION
BYPASS	4	I	Bypass
$\overline{\text{EN}}$	3	I	Enable input
GND	2		Ground
IN	1	I	Input supply voltage
OUT	5	O	Regulated output voltage

TPS79015, TPS79018, TPS79025, TPS79028, TPS79030 ULTRALOW-POWER LOW-NOISE 50-mA LOW-DROPOUT LINEAR REGULATORS

SLVS299B – SEPTEMBER 2000 – REVISED MAY 2001

detail description

The TPS790xx uses a PMOS pass element to dramatically reduce both dropout voltage and supply current over more conventional PNP-pass-element LDO designs. The PMOS pass element is a voltage-controlled device and, unlike a PNP transistor, it does not require increased drive current as output current increases. Supply current in the TPS790xx is essentially constant from no load to maximum load.

The TPS790xx family of low-dropout (LDO) regulators have been optimized for use in battery-operated equipment. They feature extremely low dropout voltages, low output noise, low quiescent current (17 μ A typically), and enable inputs to reduce supply currents to 1 μ A when the regulators are turned off.

The internal voltage reference is a key source of noise in a LDO regulator. The TPS790xx has a BYPASS pin which is connected to the voltage reference through a 150-k Ω internal resistor. The 150-k Ω internal resistor, in conjunction with an external bypass capacitor connected to the BYPASS pin, creates a low pass filter to reduce the voltage reference noise and, therefore, the noise at the regulator output. Note that the output will start up slower as the bypass capacitance increases due to the RC time constant at the bypass pin that is created by the internal 150-k Ω resistor and external capacitor.

Current limiting and thermal protection prevent damage by excessive output current and/or power dissipation. The device switches into a constant-current mode at approximately 350 mA; further load reduces the output voltage instead of increasing the output current. The thermal protection shuts the regulator off if the junction temperature rises above approximately 165°C. Recovery is automatic when the junction temperature drops approximately 25°C below the high temperature trip point. The PMOS pass element includes a back gate diode that conducts reverse current when the input voltage level drops below the output voltage level.

A voltage of 1.7 V or greater on the EN input will disable the TPS790xx internal circuitry, reducing the supply current to 1 μ A. A voltage of less than 0.9 V on the $\overline{\text{EN}}$ input will enable the TPS790xx and will enable normal operation to resume. The $\overline{\text{EN}}$ input does not include any deliberate hysteresis, and it exhibits an actual switching threshold of approximately 1.5 V.

absolute maximum ratings over operating free-air temperature range (unless otherwise noted)[†]

Input voltage range (see Note 1)	–0.3 V to 13.5 V
Voltage range at EN	–0.3 V to $V_I + 0.3$ V
Voltage on OUT, FB	7 V
Peak output current	Internally limited
ESD rating, HBM	2 kV
Continuous total power dissipation	See Dissipation Rating Table
Operating virtual junction temperature range, T_J	–40°C to 150°C
Storage temperature range, T_{stg}	–65°C to 150°C

[†] Stresses beyond those listed under “absolute maximum ratings” may cause permanent damage to the device. These are stress ratings only, and functional operation of the device at these or any other conditions beyond those indicated under “recommended operating conditions” is not implied. Exposure to absolute-maximum-rated conditions for extended periods may affect device reliability.

NOTE 1: All voltage values are with respect to network ground terminal.

DISSIPATION RATING TABLE

BOARD	PACKAGE	$R_{\theta\text{JC}}$	$R_{\theta\text{JA}}$	DERATING FACTOR ABOVE $T_A = 25^\circ\text{C}$	$T_A \leq 25^\circ\text{C}$ POWER RATING	$T_A = 70^\circ\text{C}$ POWER RATING	$T_A = 85^\circ\text{C}$ POWER RATING
Low K [‡]	DBV	65.8 °C/W	259 °C/W	3.9 mW/°C	386 mW	212 mW	154 mW
High K [§]	DBV	65.8 °C/W	180 °C/W	5.6 mW/°C	555 mW	305 mW	222 mW

[‡] The JEDEC Low K (1s) board design used to derive this data was a 3 inch x 3 inch, two layer board with 2 ounce copper traces on top of the board.

[§] The JEDEC High K (2s2p) board design used to derive this data was a 3 inch x 3 inch, multilayer board with 1 ounce internal power and ground planes and 2 ounce copper traces on top and bottom of the board.



TPS79015, TPS79018, TPS79025, TPS79028, TPS79030

ULTRALOW-POWER LOW-NOISE 50-mA LOW-DROPOUT LINEAR REGULATORS

SLVS299B – SEPTEMBER 2000 – REVISED MAY 2001

recommended operating conditions

	MIN	NOM	MAX	UNIT
Input voltage, V_I (see Note 2)	2.7		10	V
Continuous output current, I_O (see Note 3)	0		50	mA
Operating junction temperature, T_J	-40		125	°C

NOTES: 2. To calculate the minimum input voltage for your maximum output current, use the following formula:

$$V_{I(\min)} = V_{O(\max)} + V_{DO}(\text{max load})$$

3. Continuous output current and operating junction temperature are limited by internal protection circuitry, but it is not recommended that the device operate under conditions beyond those specified in this table for extended periods of time.

electrical characteristics over recommended operating free-air temperature range, $V_I = V_{O(\text{typ})} + 1 \text{ V}$, $I_O = 1 \text{ mA}$, $\overline{EN} = 0 \text{ V}$, $C_O = 4.7 \mu\text{F}$ (unless otherwise noted)

PARAMETER		TEST CONDITIONS	MIN	TYP	MAX	UNIT
Output voltage (10 μA to 50 mA load) (see Note 4)	TPS79015	$T_J = 25^\circ\text{C}$, $2.7 \text{ V} < V_I < 10 \text{ V}$		1.5		V
		$T_J = -40^\circ\text{C}$ to 125°C , $2.7 \text{ V} < V_I < 10 \text{ V}$	1.455		1.545	
	TPS79018	$T_J = 25^\circ\text{C}$, $2.8 \text{ V} < V_I < 10 \text{ V}$		1.8		
		$T_J = -40^\circ\text{C}$ to 125°C , $2.8 \text{ V} < V_I < 10 \text{ V}$	1.746		1.854	
	TPS79025	$T_J = 25^\circ\text{C}$, $3.5 \text{ V} < V_I < 10 \text{ V}$		2.5		
		$T_J = -40^\circ\text{C}$ to 125°C , $3.5 \text{ V} < V_I < 10 \text{ V}$	2.425		2.575	
	TPS79028	$T_J = 25^\circ\text{C}$, $3.8 \text{ V} < V_I < 10 \text{ V}$		2.8		
		$T_J = -40^\circ\text{C}$ to 125°C , $3.8 \text{ V} < V_I < 10 \text{ V}$	2.716		2.884	
	TPS79030	$T_J = 25^\circ\text{C}$, $4.0 \text{ V} < V_I < 10 \text{ V}$		3		
		$T_J = -40^\circ\text{C}$ to 125°C , $4.0 \text{ V} < V_I < 10 \text{ V}$	2.910		3.090	
Quiescent current (GND current) (see Note 4)		$\overline{EN} = 0 \text{ V}$, $10 \mu\text{A} < I_O < 50 \text{ mA}$, $T_J = 25^\circ\text{C}$		17		μA
		$\overline{EN} = 0 \text{ V}$, $I_O = 50 \text{ mA}$, $T_J = -40^\circ\text{C}$ to 125°C			28	
Load regulation		$\overline{EN} = 0 \text{ V}$, $I_O = 10 \mu\text{A}$ to 50 mA , $T_J = 25^\circ\text{C}$		8		mV
Output voltage line regulation ($\Delta V_O/V_O$) (see Notes 4 and 5)		$V_O + 1 \text{ V} < V_I \leq 10 \text{ V}$, $T_J = 25^\circ\text{C}$		0.04		%V
		$V_O + 1 \text{ V} < V_I \leq 10 \text{ V}$, $T_J = -40^\circ\text{C}$ to 125°C			0.1	
Output noise voltage (TPS79030)		BW = 300 Hz to 50 kHz, $C_{(\text{byp})} = 0.01 \mu\text{F}$, $C_O = 10 \mu\text{F}$, $I_O = 50 \text{ mA}$, $T_J = 25^\circ\text{C}$		56		μV_{rms}
Output current limit		$V_O = 0 \text{ V}$, See Note 4		350	750	mA
Standby current		$\overline{EN} = V_I$, $2.7 < V_I < 10 \text{ V}$		1		μA
		$T_J = -40^\circ\text{C}$ to 125°C			2	μA

NOTES: 4. The minimum IN operating voltage is 2.7 V or $V_O(\text{typ}) + 1 \text{ V}$, whichever is greater. The maximum IN voltage is 10 V. The minimum output current is 10 μA and the maximum output current is 50 mA.

5. If $V_O \leq 1.8 \text{ V}$ then $V_{I\min} = 2.7 \text{ V}$, $V_{I\max} = 10 \text{ V}$:

$$\text{Line Reg. (mV)} = (\%/V) \times \frac{V_O(V_{I\max} - 2.7 \text{ V})}{100} \times 1000$$

If $V_O \geq 2.5 \text{ V}$ then $V_{I\min} = V_O + 1 \text{ V}$, $V_{I\max} = 10 \text{ V}$:

$$\text{Line Reg. (mV)} = (\%/V) \times \frac{V_O(V_{I\max} - (V_O + 1 \text{ V}))}{100} \times 1000$$



TPS79015, TPS79018, TPS79025, TPS79028, TPS79030
ULTRALOW-POWER LOW-NOISE 50-mA
LOW-DROPOUT LINEAR REGULATORS

SLVS299B – SEPTEMBER 2000 – REVISED MAY 2001

**electrical characteristics over recommended operating free-air temperature range,
 $V_I = V_{O(\text{typ})} + 1 \text{ V}$, $I_O = 1 \text{ mA}$, $\overline{EN} = 0 \text{ V}$, $C_O = 4.7 \mu\text{F}$ (unless otherwise noted) (continued)**

PARAMETER		TEST CONDITIONS	MIN	TYP	MAX	UNIT
High level enable input voltage		$2.7 \text{ V} < V_I < 10 \text{ V}$	1.7			V
Low level enable input voltage		$2.7 \text{ V} < V_I < 10 \text{ V}$			0.9	V
Power supply ripple rejection (TPS79030)		$f = 1 \text{ kHz}$, $T_J = 25^\circ\text{C}$, $C_O = 10 \mu\text{F}$, $C(\text{byp}) = 0.01 \mu\text{F}$		85		dB
Input current (EN)		$\overline{EN} = 0 \text{ V}$	-1	0	1	μA
		$\overline{EN} = V_I$	-1		1	μA
Dropout voltage (see Note 6)	TPS79028	$I_O = 50 \text{ mA}$, $T_J = 25^\circ\text{C}$		60		mV
		$I_O = 50 \text{ mA}$, $T_J = -40^\circ\text{C to } 125^\circ\text{C}$			125	
Dropout voltage (see Note 6)	TPS79030	$I_O = 50 \text{ mA}$, $T_J = 25^\circ\text{C}$		57		
		$I_O = 50 \text{ mA}$, $T_J = -40^\circ\text{C to } 125^\circ\text{C}$			115	

6. I_N voltage equals $V_{O(\text{typ})} - 100 \text{ mV}$; The TPS79030 output voltage is set to 2.9 V. The TPS79015, TPS79018, and TPS79025 dropout voltage is limited by input voltage range limitations.

TYPICAL CHARACTERISTICS

Table of Graphs

		FIGURE	
V_O	Output voltage	vs Output current	1, 2, 3
		vs Junction temperature	4, 5, 6
	Ground current	vs Junction temperature	7
	Output spectral noise density	vs Frequency	8 – 10
	Root mean squared output noise	vs Bypass capacitance	11
Z_O	Output impedance	vs Frequency	12
V_{DO}	Dropout voltage	vs Junction temperature	13
	Ripple rejection	vs Frequency	14 – 16
V_O	Output voltage, enable voltage	vs Time (start-up)	17 – 19
	Line transient response		20, 22
	Load transient response		21, 23
	Equivalent series resistance (ESR)	vs Output current	24, 25

TPS79015, TPS79018, TPS79025, TPS79028, TPS79030
ULTRALOW-POWER LOW-NOISE 50-mA
LOW-DROPOUT LINEAR REGULATORS

SLVS299B – SEPTEMBER 2000 – REVISED MAY 2001

TYPICAL CHARACTERISTICS

TPS79025
OUTPUT VOLTAGE
vs
OUTPUT CURRENT

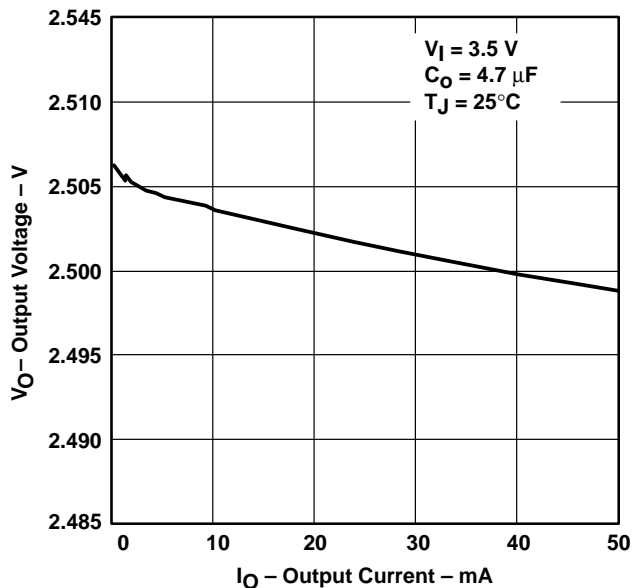

Figure 1

TPS79015
OUTPUT VOLTAGE
vs
OUTPUT CURRENT

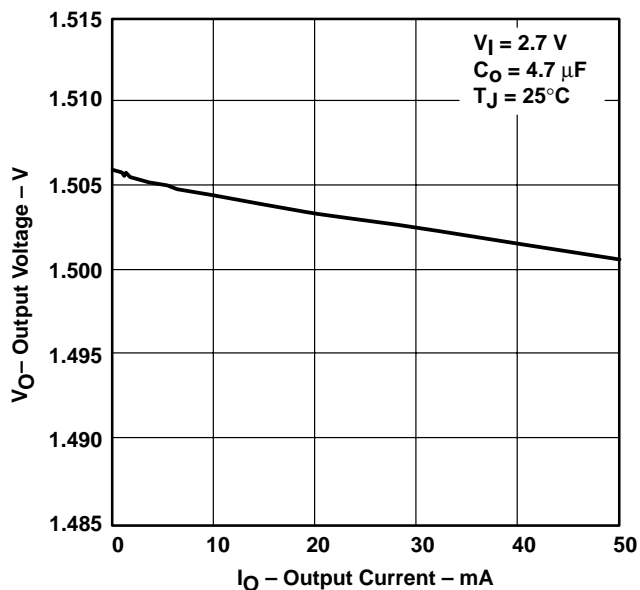

Figure 2

TPS79030
OUTPUT VOLTAGE
vs
OUTPUT CURRENT

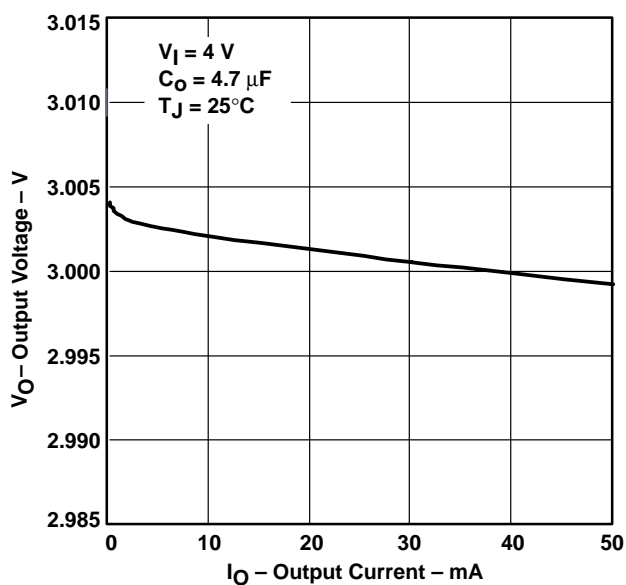

Figure 3

TPS79015
OUTPUT VOLTAGE
vs
JUNCTION TEMPERATURE

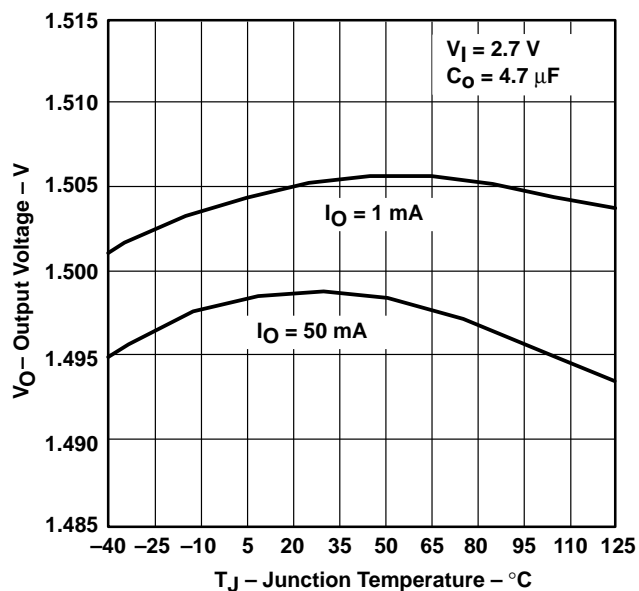

Figure 4



TYPICAL CHARACTERISTICS

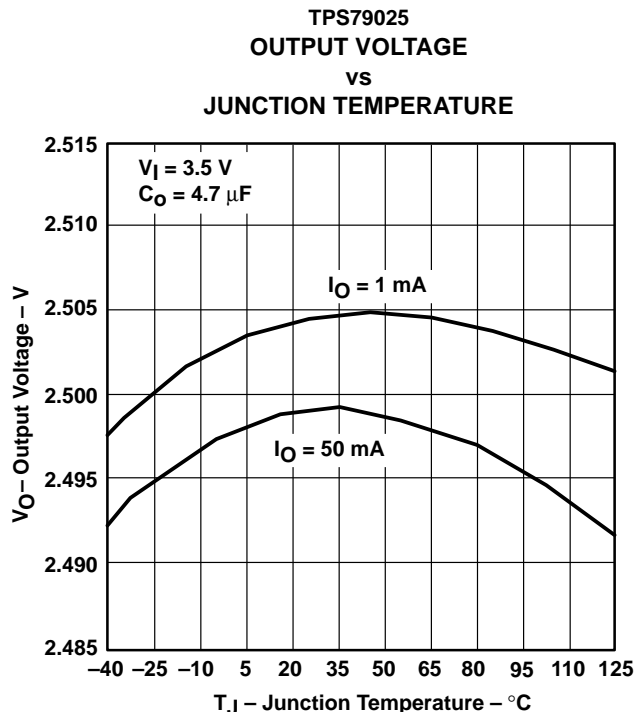

Figure 5

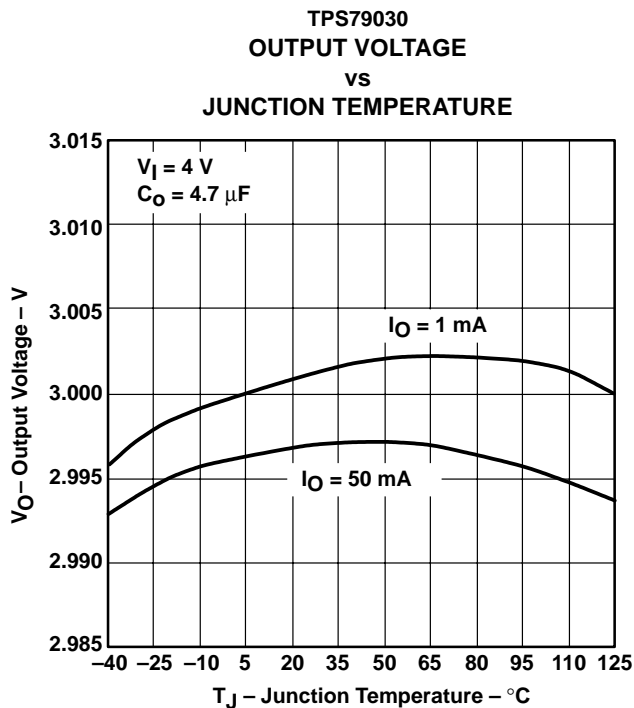

Figure 6

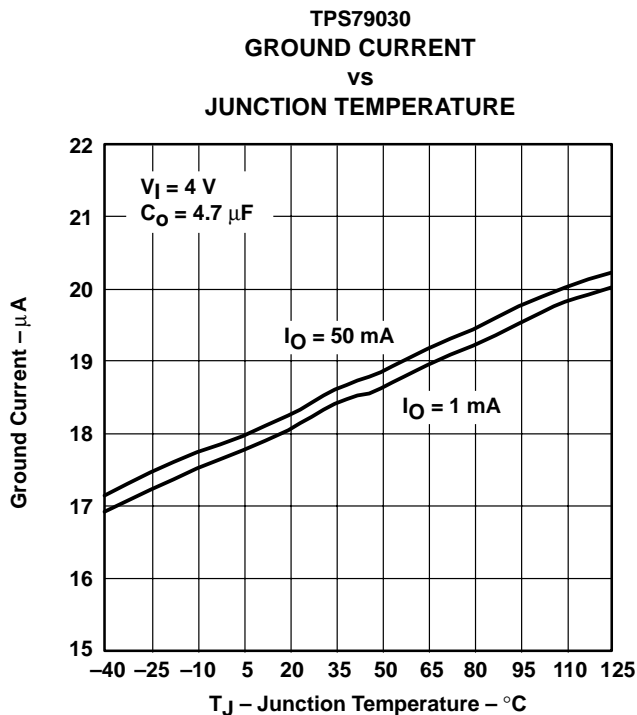

Figure 7

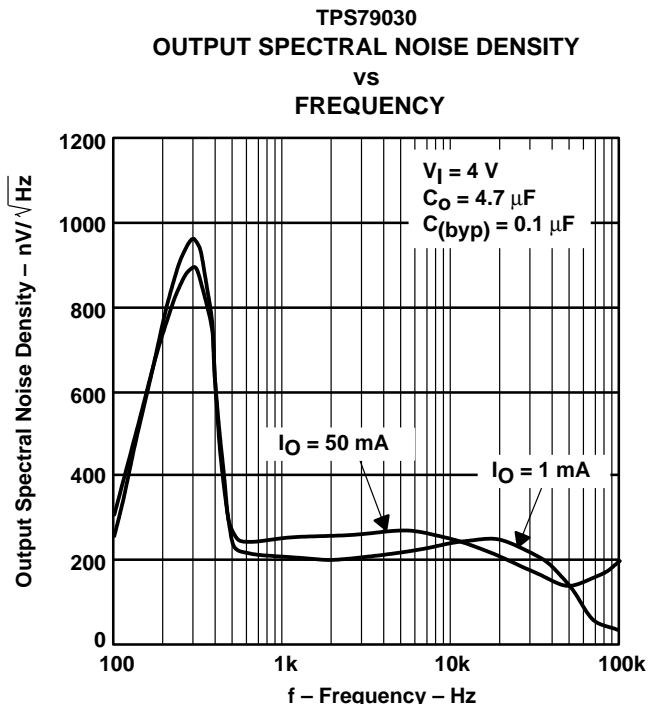

Figure 8

TPS79015, TPS79018, TPS79025, TPS79028, TPS79030
ULTRALOW-POWER LOW-NOISE 50-mA
LOW-DROPOUT LINEAR REGULATORS

SLVS299B – SEPTEMBER 2000 – REVISED MAY 2001

TYPICAL CHARACTERISTICS

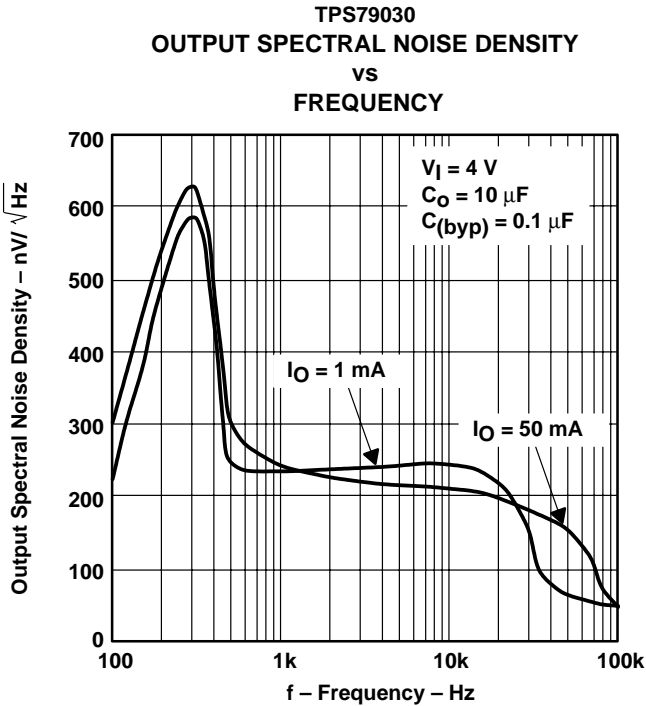

Figure 9

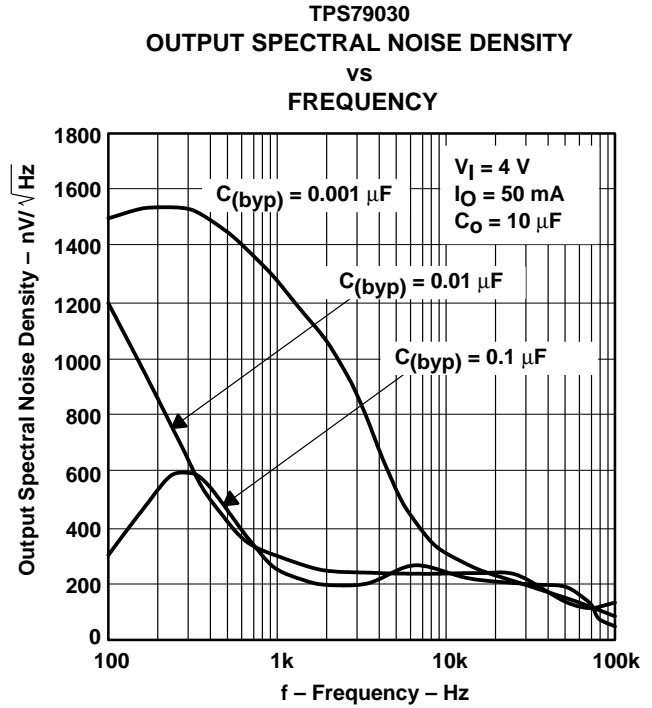

Figure 10

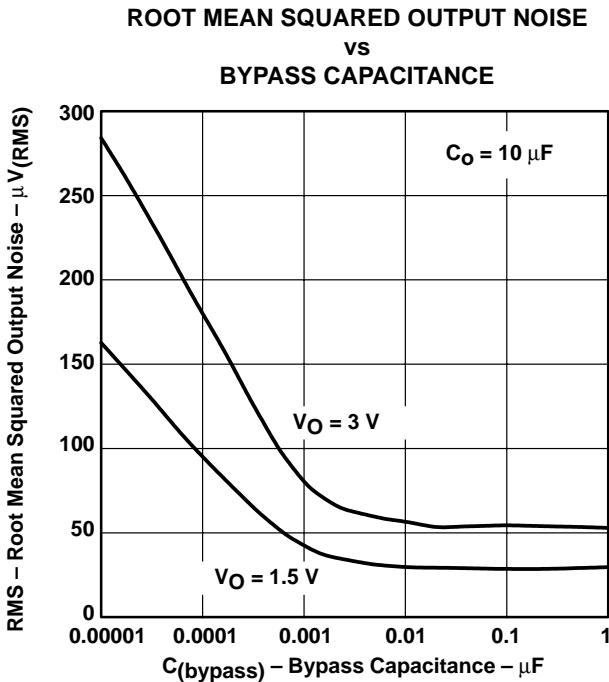

Figure 11

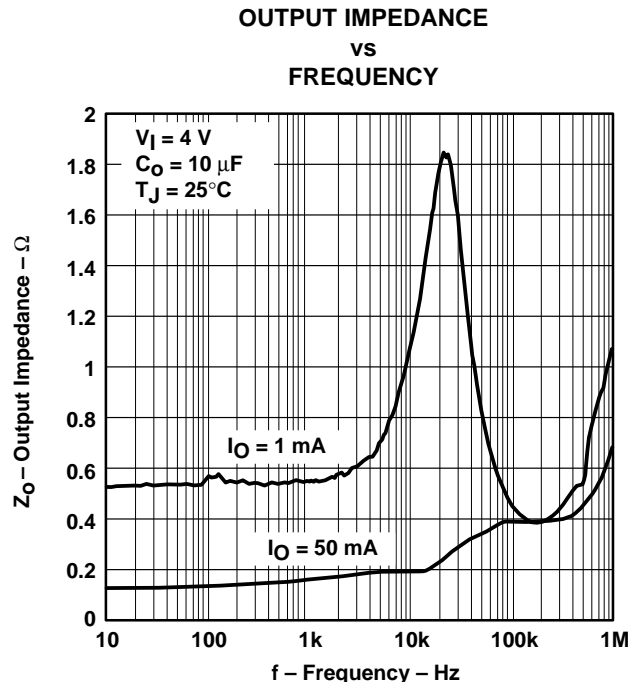
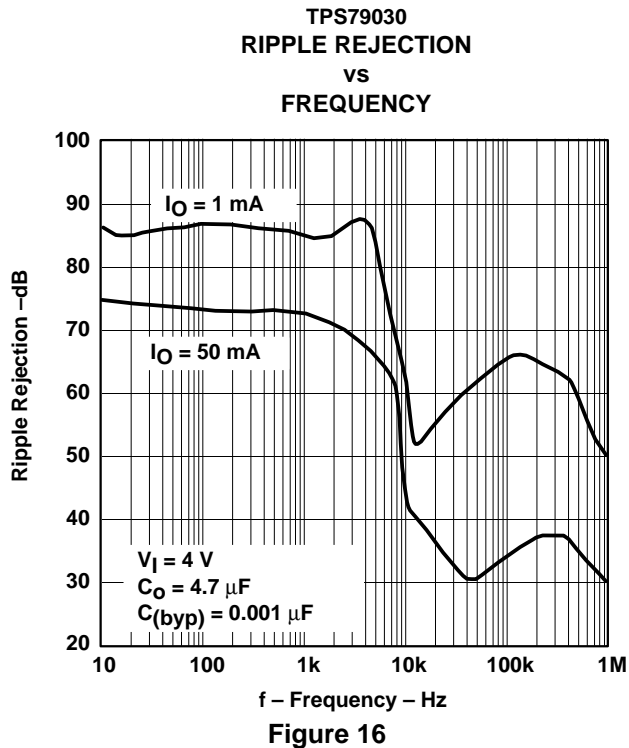
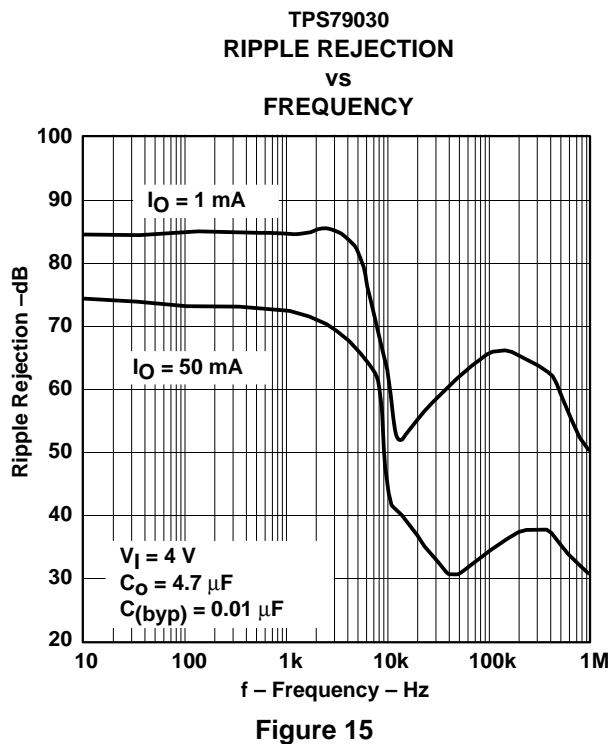
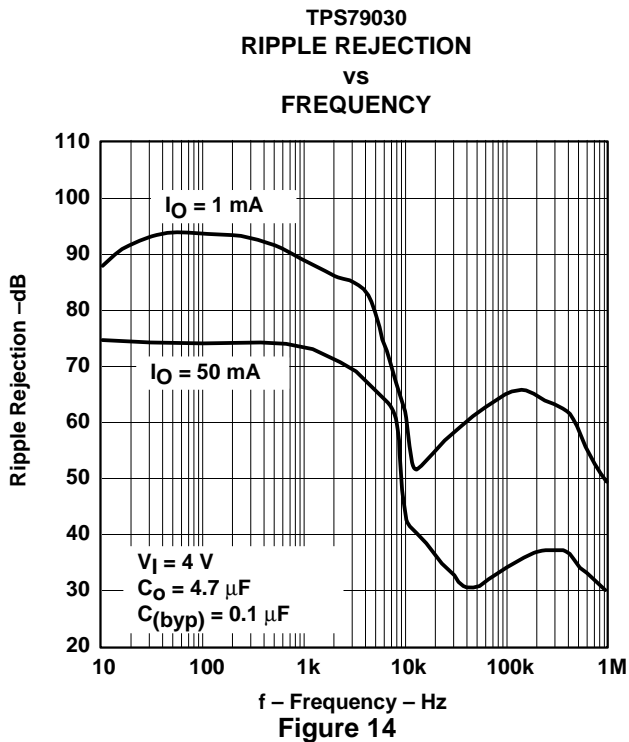
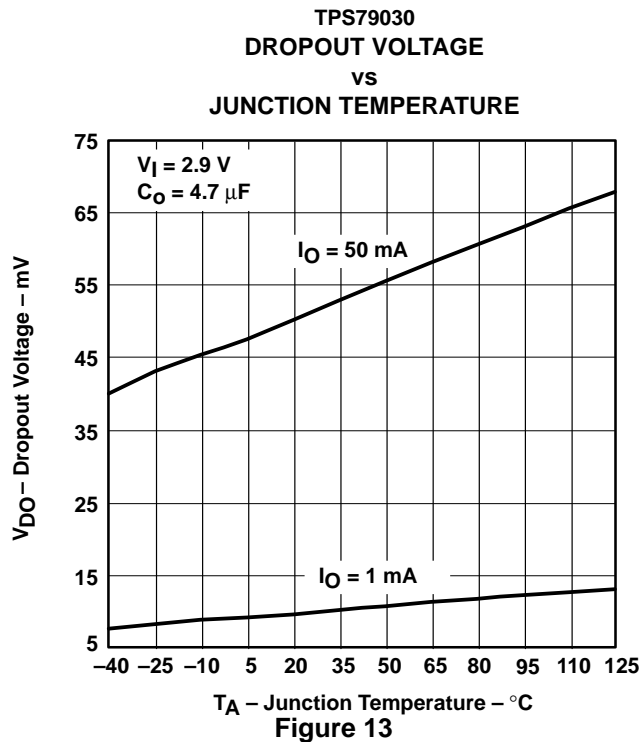

Figure 12

TYPICAL CHARACTERISTICS



TPS79015, TPS79018, TPS79025, TPS79028, TPS79030
 ULTRALOW-POWER LOW-NOISE 50-mA
 LOW-DROPOUT LINEAR REGULATORS

SLVS299B – SEPTEMBER 2000 – REVISED MAY 2001

TYPICAL CHARACTERISTICS

TPS79030
 OUTPUT VOLTAGE, ENABLE VOLTAGE
 vs
 TIME (START-UP)

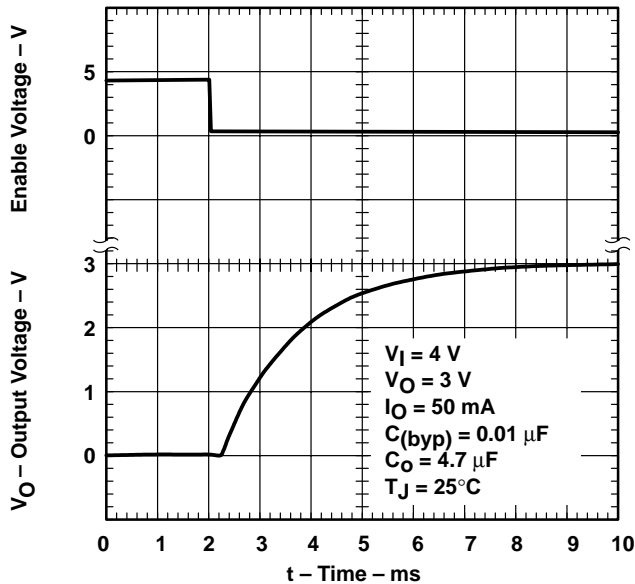

Figure 17

TPS79030
 OUTPUT VOLTAGE, ENABLE VOLTAGE
 vs
 TIME (START-UP)

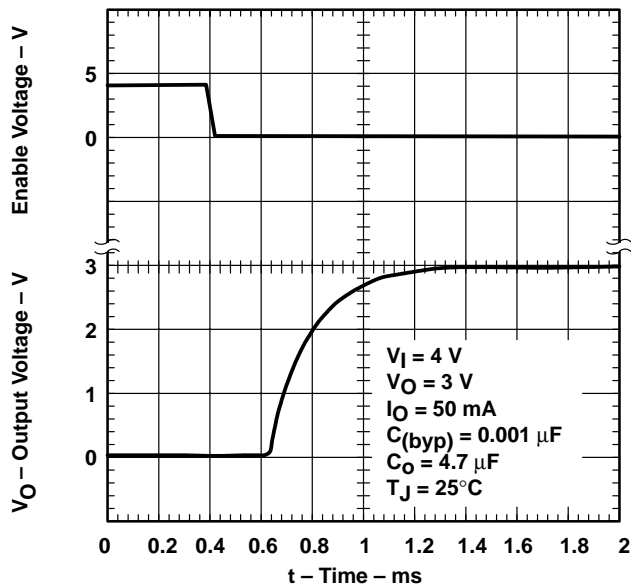

Figure 18

TPS79030
 OUTPUT VOLTAGE, ENABLE VOLTAGE
 vs
 TIME (START-UP)

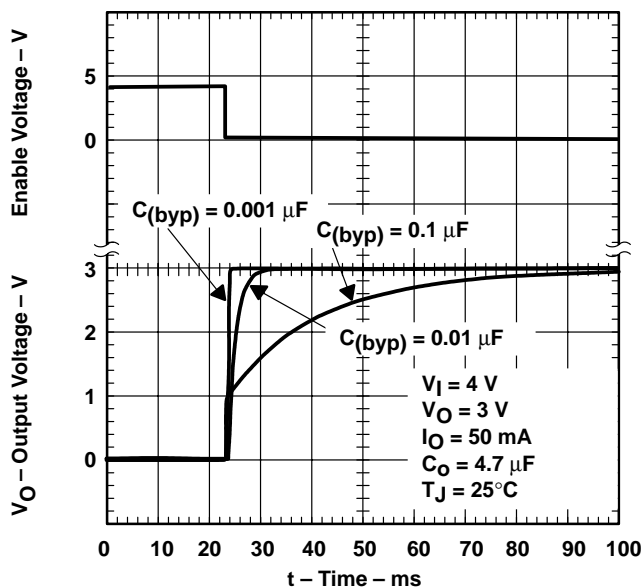

Figure 19



TYPICAL CHARACTERISTICS

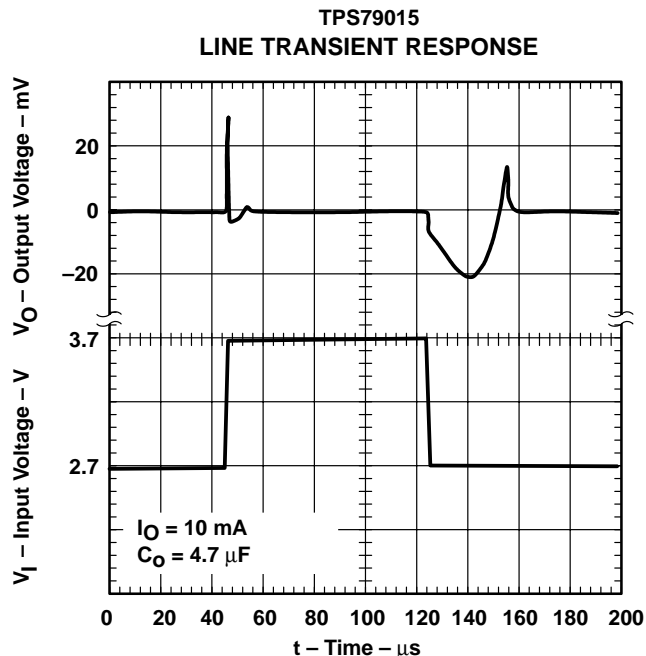

Figure 20

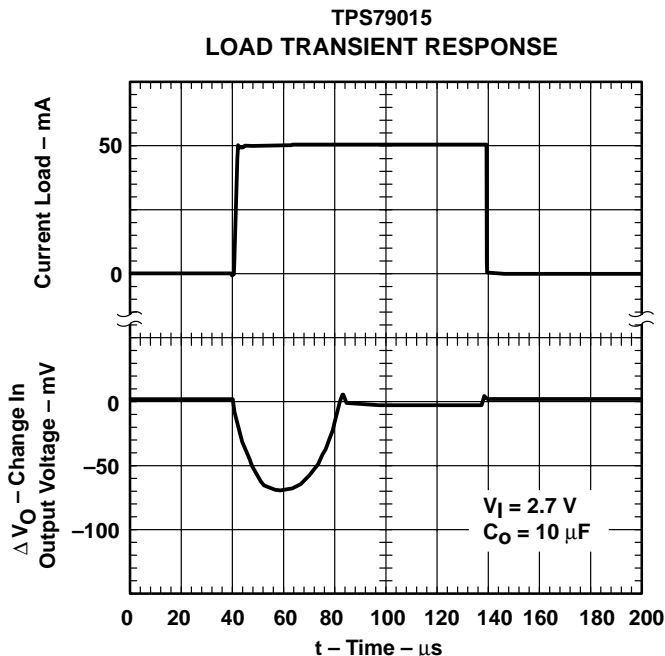

Figure 21

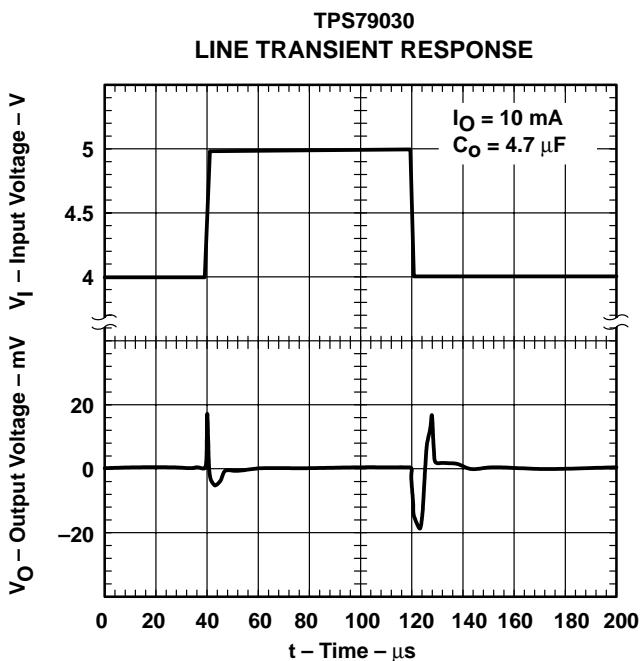

Figure 22

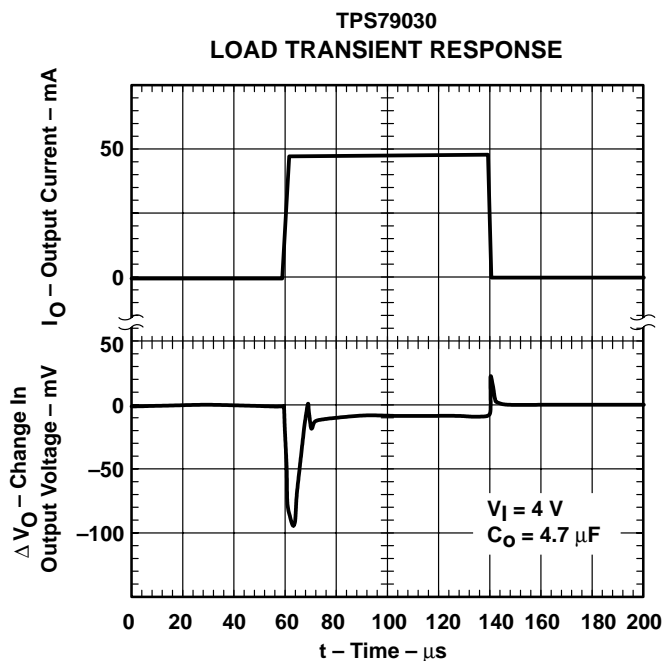

Figure 23

TPS79015, TPS79018, TPS79025, TPS79028, TPS79030
 ULTRALOW-POWER LOW-NOISE 50-mA
 LOW-DROPOUT LINEAR REGULATORS

SLVS299B – SEPTEMBER 2000 – REVISED MAY 2001

TYPICAL CHARACTERISTICS

TPS79030
 TYPICAL REGIONS OF STABILITY
 EQUIVALENT SERIES RESISTANCE (ESR)
 vs
 OUTPUT CURRENT

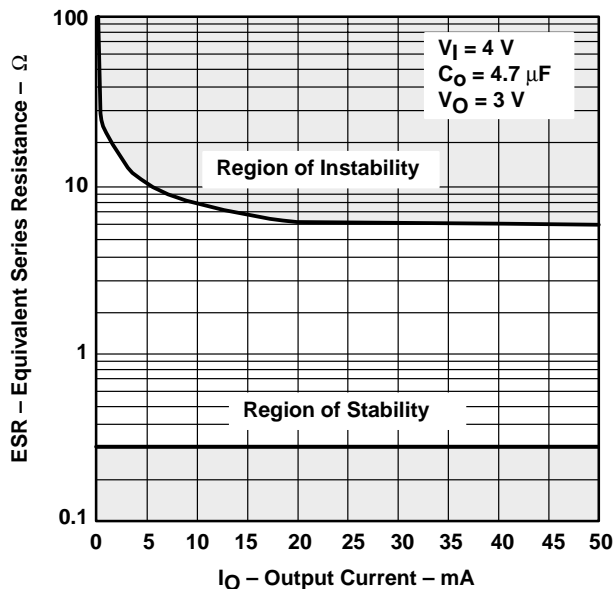

Figure 24

TPS79030
 TYPICAL REGIONS OF STABILITY
 EQUIVALENT SERIES RESISTANCE (ESR)
 vs
 OUTPUT CURRENT

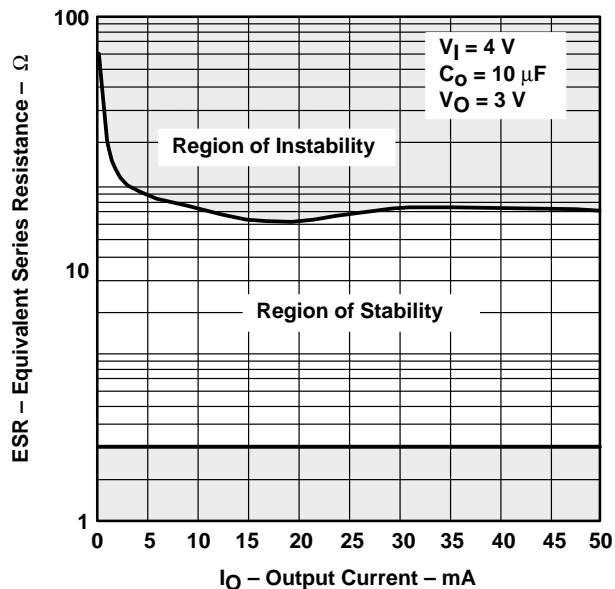

Figure 25

APPLICATION INFORMATION

The TPS790xx family of low-dropout (LDO) regulators have been optimized for use in battery-operated equipment. They feature extremely low dropout voltages, low quiescent current (17 μA typically), and enable inputs to reduce supply currents to less than 1 μA when the regulators are turned off.

A typical application circuit is shown in Figure 26.

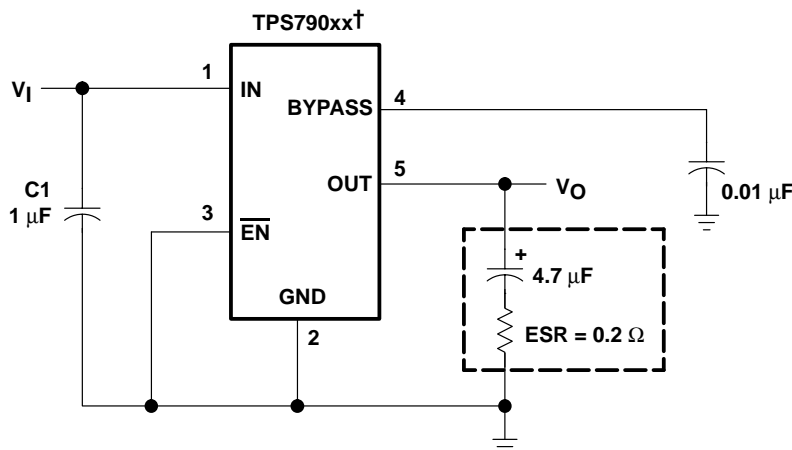

Figure 26. Typical Application Circuit

external capacitor requirements

Although not required, a 0.047- μF or larger ceramic input bypass capacitor, connected between IN and GND and located close to the TPS790xx, is recommended to improve transient response and noise rejection. A higher-value electrolytic input capacitor may be necessary if large, fast-rise-time load transients are anticipated and the device is located several inches from the power source.

Like all low dropout regulators, the TPS790xx requires an output capacitor connected between OUT and GND to stabilize the internal control loop. The minimum recommended capacitance is 4.7 μF . The ESR (equivalent series resistance) of the capacitor should be between 0.2 Ω and 10 Ω to ensure stability. Capacitor values larger than 4.7 μF are acceptable, and allow the use of smaller ESR values. Capacitances less than 4.7 μF are not recommended because they require careful selection of ESR to ensure stability. Solid tantalum electrolytic, aluminum electrolytic, and multilayer ceramic capacitors are all suitable, provided they meet the requirements described above. Most of the commercially available 4.7 μF surface-mount solid tantalum capacitors, including devices from Sprague, Kemet, and Nichico, meet the ESR requirements stated above. Multilayer ceramic capacitors may have very small equivalent series resistances and may thus require the addition of a low value series resistor to ensure stability.

CAPACITOR SELECTION

PART NO.	MFR.	VALUE	MAX ESR†	SIZE (H × L × W)†
T494B475K016AS	KEMET	4.7 μF	1.5 Ω	1.9 × 3.5 × 2.8
195D106x0016x2T	SPRAGUE	10 μF	1.5 Ω	1.3 × 7.0 × 2.7
695D106x003562T	SPRAGUE	10 μF	1.3 Ω	2.5 × 7.6 × 2.5
TPSC475K035R0600	AVX	4.7 μF	0.6 Ω	2.6 × 6.0 × 3.2

† Size is in mm. The ESR maximum resistance is in Ohms at 100 kHz and $T_A = 25^\circ\text{C}$. Contact the manufacturer for the minimum ESR values.

APPLICATION INFORMATION

external capacitor requirements (continued)

The external bypass capacitor, used in conjunction with an internal resistor to form a low-pass filter, should be a low ESR ceramic capacitor. For example, the TPS79030 exhibits only $56 \mu\text{V}_{\text{RMS}}$ of output voltage noise using a $0.01 \mu\text{F}$ ceramic bypass capacitor and a $10 \mu\text{F}$ ceramic output capacitors. Note that the output will start up slower as the bypass capacitance increases due to the RC time constant at the bypass pin that is created by the internal $150 \text{ k}\Omega$ resistor and external capacitor.

power dissipation and junction temperature

Specified regulator operation is assured to a junction temperature of 125°C ; the maximum junction temperature should be restricted to 125°C under normal operating conditions. This restriction limits the power dissipation the regulator can handle in any given application. To ensure the junction temperature is within acceptable limits, calculate the maximum allowable dissipation, $P_{\text{D(max)}}$, and the actual dissipation, P_{D} , which must be less than or equal to $P_{\text{D(max)}}$.

The maximum-power-dissipation limit is determined using the following equation:

$$P_{\text{D(max)}} = \frac{T_{\text{Jmax}} - T_{\text{A}}}{R_{\theta\text{JA}}}$$

Where:

T_{Jmax} is the maximum allowable junction temperature.

$R_{\theta\text{JA}}$ is the thermal resistance junction-to-ambient for the package, see the dissipation rating table.

T_{A} is the ambient temperature.

The regulator dissipation is calculated using:

$$P_{\text{D}} = (V_{\text{I}} - V_{\text{O}}) \times I_{\text{O}}$$

Power dissipation resulting from quiescent current is negligible. Excessive power dissipation will trigger the thermal protection circuit.

regulator protection

The TPS790xx PMOS-pass transistor has a built-in back diode that conducts reverse current when the input voltage drops below the output voltage (e.g., during power down). Current is conducted from the output to the input and is not internally limited. If extended reverse voltage operation is anticipated, external limiting might be appropriate.

The TPS790xx features internal current limiting and thermal protection. During normal operation, the TPS790xx limits output current to approximately 350 mA . When current limiting engages, the output voltage scales back linearly until the overcurrent condition ends. While current limiting is designed to prevent gross device failure, care should be taken not to exceed the power dissipation ratings of the package. If the temperature of the device exceeds approximately 165°C , thermal-protection circuitry shuts it down. Once the device has cooled down to below approximately 140°C , regulator operation resumes.

TPS79015, TPS79018, TPS79025, TPS79028, TPS79030
 ULTRALOW-POWER LOW-NOISE 50-mA
 LOW-DROPOUT LINEAR REGULATORS

SLVS299B – SEPTEMBER 2000 – REVISED MAY 2001

MECHANICAL DATA

DBV (R-PDSO-G5)

PLASTIC SMALL-OUTLINE

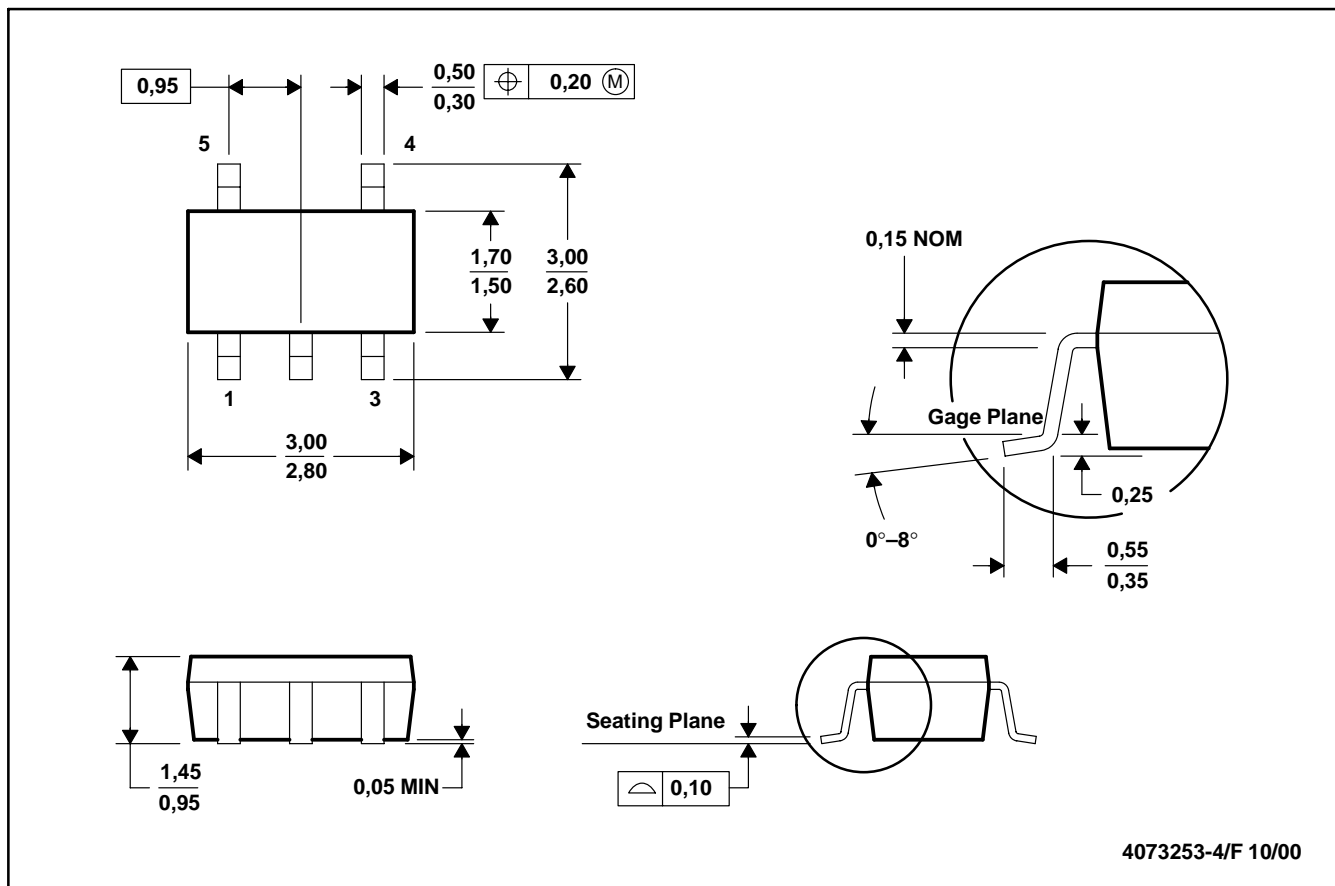

- NOTES: A. All linear dimensions are in millimeters.
 B. This drawing is subject to change without notice.
 C. Body dimensions do not include mold flash or protrusion.
 D. Falls within JEDEC MO-178

PACKAGING INFORMATION

Orderable Device	Status ⁽¹⁾	Package Type	Package Drawing	Pins	Package Qty	Eco Plan ⁽²⁾	Lead/Ball Finish	MSL Peak Temp ⁽³⁾
TPS79015DBVR	ACTIVE	SOT-23	DBV	5	3000	Green (RoHS & no Sb/Br)	CU NIPDAU	Level-1-260C-UNLIM
TPS79015DBVRG4	ACTIVE	SOT-23	DBV	5	3000	Green (RoHS & no Sb/Br)	CU NIPDAU	Level-1-260C-UNLIM
TPS79015DBVT	ACTIVE	SOT-23	DBV	5	250	Green (RoHS & no Sb/Br)	CU NIPDAU	Level-1-260C-UNLIM
TPS79018DBVR	ACTIVE	SOT-23	DBV	5	3000	Green (RoHS & no Sb/Br)	CU NIPDAU	Level-1-260C-UNLIM
TPS79018DBVRG4	ACTIVE	SOT-23	DBV	5	3000	Green (RoHS & no Sb/Br)	CU NIPDAU	Level-1-260C-UNLIM
TPS79018DBVT	ACTIVE	SOT-23	DBV	5	250	Green (RoHS & no Sb/Br)	CU NIPDAU	Level-1-260C-UNLIM
TPS79018DBVTG4	ACTIVE	SOT-23	DBV	5	250	Green (RoHS & no Sb/Br)	CU NIPDAU	Level-1-260C-UNLIM
TPS79025DBVR	ACTIVE	SOT-23	DBV	5	3000	Green (RoHS & no Sb/Br)	CU NIPDAU	Level-1-260C-UNLIM
TPS79025DBVRG4	ACTIVE	SOT-23	DBV	5	3000	Green (RoHS & no Sb/Br)	CU NIPDAU	Level-1-260C-UNLIM
TPS79025DBVT	ACTIVE	SOT-23	DBV	5	250	Green (RoHS & no Sb/Br)	CU NIPDAU	Level-1-260C-UNLIM
TPS79028DBVR	ACTIVE	SOT-23	DBV	5	3000	Green (RoHS & no Sb/Br)	CU NIPDAU	Level-1-260C-UNLIM
TPS79028DBVRG4	ACTIVE	SOT-23	DBV	5	3000	Green (RoHS & no Sb/Br)	CU NIPDAU	Level-1-260C-UNLIM
TPS79028DBVT	ACTIVE	SOT-23	DBV	5	250	Green (RoHS & no Sb/Br)	CU NIPDAU	Level-1-260C-UNLIM
TPS79028DBVTG4	ACTIVE	SOT-23	DBV	5	250	Green (RoHS & no Sb/Br)	CU NIPDAU	Level-1-260C-UNLIM
TPS79030DBVR	ACTIVE	SOT-23	DBV	5	3000	Green (RoHS & no Sb/Br)	CU NIPDAU	Level-1-260C-UNLIM
TPS79030DBVRG4	ACTIVE	SOT-23	DBV	5	3000	Green (RoHS & no Sb/Br)	CU NIPDAU	Level-1-260C-UNLIM
TPS79030DBVT	ACTIVE	SOT-23	DBV	5	250	Green (RoHS & no Sb/Br)	CU NIPDAU	Level-1-260C-UNLIM
TPS79030DBVTG4	ACTIVE	SOT-23	DBV	5	250	Green (RoHS & no Sb/Br)	CU NIPDAU	Level-1-260C-UNLIM

⁽¹⁾ The marketing status values are defined as follows:

ACTIVE: Product device recommended for new designs.

LIFEBUY: TI has announced that the device will be discontinued, and a lifetime-buy period is in effect.

NRND: Not recommended for new designs. Device is in production to support existing customers, but TI does not recommend using this part in a new design.

PREVIEW: Device has been announced but is not in production. Samples may or may not be available.

OBSOLETE: TI has discontinued the production of the device.

⁽²⁾ Eco Plan - The planned eco-friendly classification: Pb-Free (RoHS), Pb-Free (RoHS Exempt), or Green (RoHS & no Sb/Br) - please check <http://www.ti.com/productcontent> for the latest availability information and additional product content details.

TBD: The Pb-Free/Green conversion plan has not been defined.

Pb-Free (RoHS): TI's terms "Lead-Free" or "Pb-Free" mean semiconductor products that are compatible with the current RoHS requirements for all 6 substances, including the requirement that lead not exceed 0.1% by weight in homogeneous materials. Where designed to be soldered at high temperatures, TI Pb-Free products are suitable for use in specified lead-free processes.

Pb-Free (RoHS Exempt): This component has a RoHS exemption for either 1) lead-based flip-chip solder bumps used between the die and

package, or 2) lead-based die adhesive used between the die and leadframe. The component is otherwise considered Pb-Free (RoHS compatible) as defined above.

Green (RoHS & no Sb/Br): TI defines "Green" to mean Pb-Free (RoHS compatible), and free of Bromine (Br) and Antimony (Sb) based flame retardants (Br or Sb do not exceed 0.1% by weight in homogeneous material)

⁽³⁾ MSL, Peak Temp. -- The Moisture Sensitivity Level rating according to the JEDEC industry standard classifications, and peak solder temperature.

Important Information and Disclaimer:The information provided on this page represents TI's knowledge and belief as of the date that it is provided. TI bases its knowledge and belief on information provided by third parties, and makes no representation or warranty as to the accuracy of such information. Efforts are underway to better integrate information from third parties. TI has taken and continues to take reasonable steps to provide representative and accurate information but may not have conducted destructive testing or chemical analysis on incoming materials and chemicals. TI and TI suppliers consider certain information to be proprietary, and thus CAS numbers and other limited information may not be available for release.

In no event shall TI's liability arising out of such information exceed the total purchase price of the TI part(s) at issue in this document sold by TI to Customer on an annual basis.

IMPORTANT NOTICE

Texas Instruments Incorporated and its subsidiaries (TI) reserve the right to make corrections, modifications, enhancements, improvements, and other changes to its products and services at any time and to discontinue any product or service without notice. Customers should obtain the latest relevant information before placing orders and should verify that such information is current and complete. All products are sold subject to TI's terms and conditions of sale supplied at the time of order acknowledgment.

TI warrants performance of its hardware products to the specifications applicable at the time of sale in accordance with TI's standard warranty. Testing and other quality control techniques are used to the extent TI deems necessary to support this warranty. Except where mandated by government requirements, testing of all parameters of each product is not necessarily performed.

TI assumes no liability for applications assistance or customer product design. Customers are responsible for their products and applications using TI components. To minimize the risks associated with customer products and applications, customers should provide adequate design and operating safeguards.

TI does not warrant or represent that any license, either express or implied, is granted under any TI patent right, copyright, mask work right, or other TI intellectual property right relating to any combination, machine, or process in which TI products or services are used. Information published by TI regarding third-party products or services does not constitute a license from TI to use such products or services or a warranty or endorsement thereof. Use of such information may require a license from a third party under the patents or other intellectual property of the third party, or a license from TI under the patents or other intellectual property of TI.

Reproduction of information in TI data books or data sheets is permissible only if reproduction is without alteration and is accompanied by all associated warranties, conditions, limitations, and notices. Reproduction of this information with alteration is an unfair and deceptive business practice. TI is not responsible or liable for such altered documentation.

Resale of TI products or services with statements different from or beyond the parameters stated by TI for that product or service voids all express and any implied warranties for the associated TI product or service and is an unfair and deceptive business practice. TI is not responsible or liable for any such statements.

Following are URLs where you can obtain information on other Texas Instruments products and application solutions:

Products		Applications	
Amplifiers	amplifier.ti.com	Audio	www.ti.com/audio
Data Converters	dataconverter.ti.com	Automotive	www.ti.com/automotive
DSP	dsp.ti.com	Broadband	www.ti.com/broadband
Interface	interface.ti.com	Digital Control	www.ti.com/digitalcontrol
Logic	logic.ti.com	Military	www.ti.com/military
Power Mgmt	power.ti.com	Optical Networking	www.ti.com/opticalnetwork
Microcontrollers	microcontroller.ti.com	Security	www.ti.com/security
		Telephony	www.ti.com/telephony
		Video & Imaging	www.ti.com/video
		Wireless	www.ti.com/wireless

Mailing Address: Texas Instruments
Post Office Box 655303 Dallas, Texas 75265

Copyright © 2006, Texas Instruments Incorporated