

Nios[®] II

Nios II Processor Reference Handbook



101 Innovation Drive
San Jose, CA 95134
www.altera.com

NII5V1-9.0

Copyright © 2009 Altera Corporation. All rights reserved. Altera, The Programmable Solutions Company, the stylized Altera logo, specific device designations, and all other words and logos that are identified as trademarks and/or service marks are, unless noted otherwise, the trademarks and service marks of Altera Corporation in the U.S. and other countries. All other product or service names are the property of their respective holders. Altera products are protected under numerous U.S. and foreign patents and pending applications, maskwork rights, and copyrights. Altera warrants performance of its semiconductor products to current specifications in accordance with Altera's standard warranty, but reserves the right to make changes to any products and services at any time without notice. Altera assumes no responsibility or liability arising out of the application or use of any information, product, or service described herein except as expressly agreed to in writing by Altera Corporation. Altera customers are advised to obtain the latest version of device specifications before relying on any published information and before placing orders for products or services.



Chapter Revision Dates	ix
List of Figures	xi
List of Tables	xiii

Section I. Nios II Processor Design

Chapter 1. Introduction

Introduction	1-1
Nios II Processor System Basics	1-1
Getting Started with the Nios II Processor	1-2
Customizing Nios II Processor Designs	1-3
Configurable Soft-Core Processor Concepts	1-4
Configurable Soft-Core Processor	1-4
Flexible Peripheral Set and Address Map	1-4
Standard Peripherals	1-4
Custom Peripherals	1-5
Custom Instructions	1-5
Automated System Generation	1-5
OpenCore Plus Evaluation	1-5
Referenced Documents	1-6
Document Revision History	1-6

Chapter 2. Processor Architecture

Introduction	2-1
Processor Implementation	2-3
Register File	2-3
Arithmetic Logic Unit	2-3
Unimplemented Instructions	2-4
Custom Instructions	2-4
Floating-Point Instructions	2-4
Software Development Considerations	2-6
Reset and Debug Signals	2-7
Exception and Interrupt Controller	2-7
Exception Controller	2-7
Integral Interrupt Controller	2-8
Interrupt Vector Custom Instruction	2-8
Memory and I/O Organization	2-9
Instruction and Data Buses	2-10
Memory and Peripheral Access	2-11
Instruction Master Port	2-11
Data Master Port	2-11
Shared Memory for Instructions and Data	2-12
Cache Memory	2-12
Configurable Cache Memory Options	2-12
Effective Use of Cache Memory	2-12
Cache Bypass Methods	2-13

Tightly-Coupled Memory	2-13
Accessing Tightly-Coupled Memory	2-14
Effective Use of Tightly-Coupled Memory	2-14
Address Map	2-14
Memory Management Unit	2-14
Memory Protection Unit	2-15
JTAG Debug Module	2-16
JTAG Target Connection	2-17
Download and Execute Software	2-17
Software Breakpoints	2-17
Hardware Breakpoints	2-17
Hardware Triggers	2-17
Armed Triggers	2-18
Triggering on Ranges of Values	2-18
Trace Capture	2-18
Execution vs. Data Trace	2-19
Trace Frames	2-19
Referenced Documents	2-20
Document Revision History	2-20

Chapter 3. Programming Model

Introduction	3-1
Operating Modes	3-2
Supervisor Mode	3-2
User Mode	3-2
Memory Management Unit	3-3
Recommended Usage	3-3
Memory Management	3-3
Virtual Addressing	3-3
Memory Protection	3-4
Address Space and Memory Partitions	3-4
Virtual Memory Address Space	3-4
Physical Memory Address Space	3-5
Data Cacheability	3-6
TLB Organization	3-6
TLB Lookups	3-7
Memory Protection Unit	3-8
Memory Regions	3-8
Base Address	3-8
Region Type	3-9
Region Index	3-9
Region Size or Upper Address Limit	3-9
Access Permissions	3-9
Default Cacheability	3-9
Overlapping Regions	3-10
Enabling the MPU	3-10
General-Purpose Registers	3-10
Control Registers	3-11
The status Register	3-12
The estatus Register	3-12
The bstatus Register	3-13
The ienable Register	3-13
The ipending Register	3-13
The cpuid Register	3-13

The exception Register	3–13
The pteaddr Register	3–14
The tlbacc Register	3–14
The tlbmisc Register	3–15
The RD Flag	3–16
The WE Flag	3–17
The WAY Field	3–17
The PID Field	3–17
The DBL Flag	3–17
The BAD Flag	3–18
The PERM Flag	3–18
The D Flag	3–18
The badaddr Register	3–18
The config Register	3–19
The mpubase Register	3–19
The mpuacc Register	3–20
The MASK Field	3–21
The LIMIT Field	3–22
The C Flag	3–23
The PERM Field	3–23
The RD Flag	3–23
The WR Flag	3–23
Working with the MPU	3–24
MPU Region Read and Write Operations	3–24
MPU Initialization	3–25
Debugger Access	3–25
Exception Processing	3–25
Reset Exceptions	3–27
Break Exceptions	3–28
Processing a Break	3–28
Register Usage	3–28
Returning From a Break	3–29
Interrupt Exceptions	3–29
Instruction-Related Exceptions	3–30
Trap Instruction	3–31
Break Instruction	3–31
Unimplemented Instruction	3–31
Illegal Instruction	3–31
Supervisor-only Instruction	3–32
Supervisor-only Instruction Address	3–32
Supervisor-only Data Address	3–32
Misaligned Data Address	3–32
Misaligned Destination Address	3–33
Division Error	3–33
Fast TLB Miss	3–33
Double TLB Miss	3–34
TLB Permission Violation	3–34
MPU Region Violation	3–34
Other Exceptions	3–35
Processing Interrupt and Instruction-Related Exceptions	3–35
Determining the Cause of Interrupt and Instruction-Related Exceptions	3–36
With Extra Exception Information	3–36
Without Extra Exception Information	3–37
Nested Exception Precautions	3–37

Returning From Interrupt and Instruction-Related Exceptions	3-38
Return Address Considerations	3-38
Memory and Peripheral Access	3-38
Cache Memory	3-38
Virtual Address Aliasing	3-39
Instruction Set Categories	3-40
Data Transfer Instructions	3-40
Arithmetic and Logical Instructions	3-41
Move Instructions	3-41
Comparison Instructions	3-41
Shift and Rotate Instructions	3-42
Program Control Instructions	3-42
Other Control Instructions	3-43
Custom Instructions	3-44
No-Operation Instruction	3-44
Potential Unimplemented Instructions	3-44
Referenced Documents	3-45
Document Revision History	3-45

Chapter 4. Instantiating the Nios II Processor in SOPC Builder

Introduction	4-1
Core Nios II Page	4-1
Core Selection	4-2
Multiply and Divide Settings	4-3
Reset Vector	4-3
General Exception Vector	4-4
Memory Management Unit Settings	4-4
Fast TLB Miss Exception Vector	4-4
Memory Protection Unit Settings	4-5
Caches and Memory Interfaces Page	4-5
Instruction Master Settings	4-6
Data Master Settings	4-7
Advanced Features Page	4-8
Reset Signals	4-9
Control Registers	4-9
Exception Checking	4-10
MMU and MPU Settings Page	4-11
MMU	4-12
MPU	4-12
JTAG Debug Module Page	4-13
Debug Level Settings	4-13
Debug Signals	4-15
Break Vector	4-15
Advanced Debug Settings	4-15
Custom Instructions Page	4-16
Interrupt Vector Custom Instruction	4-17
Floating-Point Hardware Custom Instruction	4-17
Endian Converter Custom Instruction	4-18
Bitswap Custom Instruction	4-19
The Quartus II IP File	4-19
Referenced Documents	4-19
Document Revision History	4-19

Section II. Nios II Processor Implementation and Reference

Chapter 5. Nios II Core Implementation Details

Introduction	5-1
Device Family Support	5-3
Nios II/f Core	5-3
Overview	5-4
Arithmetic Logic Unit	5-4
Multiply and Divide Performance	5-4
Shift and Rotate Performance	5-6
Memory Access	5-6
Instruction and Data Master Ports	5-6
Instruction and Data Caches	5-6
Bursting	5-8
Tightly-Coupled Memory	5-9
Memory Management Unit	5-9
Micro Translation Lookaside Buffers	5-9
Memory Protection Unit	5-9
Execution Pipeline	5-10
Pipeline Stalls	5-10
Branch Prediction	5-11
Instruction Performance	5-11
Exception Handling	5-12
JTAG Debug Module	5-12
Nios II/s Core	5-12
Overview	5-13
Arithmetic Logic Unit	5-13
Multiply and Divide Performance	5-13
Shift and Rotate Performance	5-14
Memory Access	5-14
Instruction and Data Master Ports	5-14
Instruction Cache	5-15
Tightly-Coupled Memory	5-15
Execution Pipeline	5-15
Pipeline Stalls	5-16
Branch Prediction	5-16
Instruction Performance	5-17
Exception Handling	5-17
JTAG Debug Module	5-18
Nios II/e Core	5-18
Overview	5-18
Arithmetic Logic Unit	5-18
Memory Access	5-19
Instruction Execution Stages	5-19
Instruction Performance	5-19
Exception Handling	5-19
JTAG Debug Module	5-20
Referenced Documents	5-20
Document Revision History	5-20

Chapter 6. Nios II Processor Revision History

Introduction	6-1
Nios II Versions	6-1

Architecture Revisions	6-2
Core Revisions	6-3
Nios II/f Core	6-3
Nios II/s Core	6-4
Nios II/e Core	6-5
JTAG Debug Module Revisions	6-6
Referenced Documents	6-6
Document Revision History	6-6

Chapter 7. Application Binary Interface

Data Types	7-1
Memory Alignment	7-1
Register Usage	7-2
Stacks	7-3
Frame Pointer Elimination	7-4
Call Saved Registers	7-4
Further Examples of Stacks	7-4
Stack Frame for a Function With <code>alloca()</code>	7-4
Stack Frame for a Function with Variable Arguments	7-4
Stack Frame for a Function with Structures Passed By Value	7-5
Function Prologues	7-5
Prologue Variations	7-6
Arguments and Return Values	7-6
Arguments	7-7
Return Values	7-7
Relocation	7-8
Validated Relocation Types	7-9
Referenced Documents	7-9
Document Revision History	7-10

Chapter 8. Instruction Set Reference

Introduction	8-1
Word Formats	8-1
I-Type	8-1
R-Type	8-1
J-Type	8-2
Instruction Opcodes	8-2
Assembler Pseudo-Instructions	8-3
Assembler Macros	8-4
Instruction Set Reference	8-4
Referenced Documents	8-102
Document Revision History	8-102

Additional Information

How to Find Further Information	Info-1
How to Contact Altera	Info-1
Typographic Conventions	Info-1

The chapters in this book, *Nios II Processor Reference Handbook*, were revised on the following dates. Where chapters or groups of chapters are available separately, part numbers are listed.

- Chapter 1 Introduction
Revised: *March 2009*
Part Number: *NII51001-9.0.0*

- Chapter 2 Processor Architecture
Revised: *March 2009*
Part Number: *NII51002-9.0.0*

- Chapter 3 Programming Model
Revised: *March 2009*
Part Number: *NII51003-9.0.0*

- Chapter 4 Instantiating the Nios II Processor in SOPC Builder
Revised: *March 2009*
Part Number: *NII51004-9.0.0*

- Chapter 5 Nios II Core Implementation Details
Revised: *March 2009*
Part Number: *NII51015-9.0.0*

- Chapter 6 Nios II Processor Revision History
Revised: *March 2009*
Part Number: *NII51018-9.0.0*

- Chapter 7 Application Binary Interface
Revised: *March 2009*
Part Number: *NII51016-9.0.0*

- Chapter 8 Instruction Set Reference
Revised: *March 2009*
Part Number: *NII51017-9.0.0*

List of Figures

Figure 1–1: Example of a Nios II Processor System	1-3
Figure 2–1: Nios II Processor Core Block Diagram	2-2
Figure 2–2: Nios II Memory and I/O Organization	2-10
Figure 3–1: Division of Physical Memory	3-5
Figure 3–2: Relationship Between ienable, ipending, PIE and Hardware Interrupts	3-30
Figure 4–1: Core Nios II Page in the Nios II Processor MegaWizard	4-2
Figure 4–2: Caches and Memory Interfaces Page in the Nios II Processor MegaWizard	4-6
Figure 4–3: Advanced Features Page in the Nios II Processor MegaWizard	4-9
Figure 4–4: MMU and MPU Settings Page in the Nios II Processor MegaWizard	4-11
Figure 4–5: JTAG Debug Module Page in the Nios II Processor MegaWizard	4-14
Figure 4–6: Custom Instructions Page in the Nios II Processor MegaWizard	4-16
Figure 4–7: Floating Point Hardware Wizard	4-18
Figure 7–1: Stack Pointer, Frame Pointer and the Current Frame	7-3
Figure 7–2: Stack Frame after Calling alloca()	7-4
Figure 7–3: Stack Frame Using Variable Arguments	7-5

List of Tables

Table 1–1: Document Revision History	1-6
Table 2–1: Operations Supported by the Nios II ALU	2-4
Table 2–2: Hardware Conformance with IEEE 754-1985 Floating-Point Standard	2-5
Table 2–3: Floating-Point Constant Examples	2-6
Table 2–4: Interrupt Vector Custom Instruction	2-8
Table 2–5: Trigger Conditions	2-18
Table 2–6: Trigger Actions	2-18
Table 2–7: Document Revision History	2-20
Table 3–1: MMU Virtual Address Fields	3-4
Table 3–2: Virtual Memory Partitions	3-5
Table 3–3: TLB Tag Portion Contents	3-7
Table 3–4: TLB Data Portion Contents	3-7
Table 3–5: The Nios II General Purpose Registers	3-10
Table 3–6: Control Register Names and Bits	3-11
Table 3–7: status Control Register Fields	3-12
Table 3–8: status Control Register Field Descriptions	3-12
Table 3–9: estatus Control Register Fields	3-12
Table 3–10: bstatus Control Register Fields	3-13
Table 3–11: exception Control Register Field Descriptions	3-14
Table 3–12: exception Control Register Fields	3-14
Table 3–13: pteaddr Control Register Fields	3-14
Table 3–14: pteaddr Control Register Field Descriptions	3-14
Table 3–15: tlbacc Control Register Fields	3-15
Table 3–16: tlbacc Control Register Field Descriptions	3-15
Table 3–17: tlbmisc Control Register Fields	3-16
Table 3–18: tlbmisc Control Register Field Descriptions	3-16
Table 3–19: badaddr Control Register Fields	3-19
Table 3–20: badaddr Control Register Field Descriptions	3-19
Table 3–21: config Control Register Fields	3-19
Table 3–22: config Control Register Field Descriptions	3-19
Table 3–23: mpubase Control Register Fields	3-20
Table 3–24: mpubase Control Register Field Descriptions	3-20
Table 3–25: mpuacc Control Register Fields for MASK Variation	3-21
Table 3–26: mpuacc Control Register Fields for LIMIT Variation	3-21
Table 3–27: mpuacc Control Register Field Descriptions	3-21
Table 3–28: MASK Region Size Encodings	3-22
Table 3–29: Instruction Region Permission Values	3-23
Table 3–30: Data Region Permission Values	3-23
Table 3–31: Nios II Exceptions (In Decreasing Priority Order)	3-26
Table 3–32: Non-Break Exception Processing Actions	3-35
Table 3–33: Wide Data Transfer Instructions	3-40
Table 3–34: Narrow Data Transfer Instructions	3-40
Table 3–35: Arithmetic and Logical Instructions	3-41
Table 3–36: Move Instructions	3-41
Table 3–37: Comparison Instructions	3-42
Table 3–38: Shift and Rotate Instructions	3-42
Table 3–39: Unconditional Jump and Call Instructions	3-43

Table 3–40: Conditional-Branch Instructions	3-43
Table 3–41: Other Control Instructions	3-44
Table 3–42: Document Revision History	3-45
Table 4–1: Debug Configuration Features	4-13
Table 4–2: JTAG Debug Module Levels	4-14
Table 4–3: Document Revision History	4-20
Table 5–1: Nios II Processor Cores	5-1
Table 5–2: Device Family Support	5-3
Table 5–3: Hardware Multiply and Divide Details for the Nios II/f Core	5-5
Table 5–4: Cache Byte Address Fields	5-6
Table 5–5: Cache Virtual Byte Address Fields	5-7
Table 5–6: Cache Physical Byte Address Fields	5-7
Table 5–7: Data Cache Clearing Instructions	5-8
Table 5–8: Implementation Pipeline Stages for Nios II/f Core	5-10
Table 5–9: Instruction Execution Performance for Nios II/f Core 4byte/line data cache	5-11
Table 5–10: Hardware Multiply and Divide Details for the Nios II/s Core	5-14
Table 5–11: Instruction Byte Address Fields	5-15
Table 5–12: Implementation Pipeline Stages for Nios II/s Core	5-16
Table 5–13: Instruction Execution Performance for Nios II/s Core	5-17
Table 5–14: Instruction Execution Performance for Nios II/e Core	5-19
Table 5–15: Document Revision History	5-20
Table 6–1: Nios II Processor Revision History	6-1
Table 6–2: Nios II Architecture Revisions	6-2
Table 6–3: Nios II/f Core Revisions	6-3
Table 6–4: Nios II/s Core Revisions	6-4
Table 6–5: Nios II/e Core Revisions	6-5
Table 6–6: JTAG Debug Module Revisions	6-6
Table 6–7: Document Revision History	6-7
Table 7–1: Representation of Data Types	7-1
Table 7–2: Nios II ABI Register Usage	7-2
Table 7–3: Nios II Relocation Calculation	7-8
Table 7–4: Document Revision History	7-10
Table 8–1: OP Encodings	8-2
Table 8–2: OPX Encodings for R-Type Instructions	8-3
Table 8–3: Assembler Pseudo-Instructions	8-3
Table 8–4: Assembler Macros	8-4
Table 8–5: Notation Conventions	8-5
Table 8–6: Document Revision History	8-102

This section provides information about the Nios® II processor.

This section includes the following chapters:

- [Chapter 1, Introduction](#)
- [Chapter 2, Processor Architecture](#)
- [Chapter 3, Programming Model](#)
- [Chapter 4, Instantiating the Nios II Processor in SOPC Builder](#)

Introduction

This handbook is the primary reference for the Nios® II family of embedded processors. The handbook describes the Nios II processor from a high-level conceptual description to the low-level details of implementation. The chapters in this handbook define the Nios II processor architecture, the programming model, the instruction set, and more.

 This handbook is part of a larger collection of documents covering the Nios II processor and its usage that you can find on the [Literature: Nios II Processor](#) page on the Altera website.

This handbook assumes you have a basic familiarity with embedded processor concepts. You do not need to be familiar with any specific Altera® technology or with Altera development tools. This handbook intentionally minimizes discussion of hardware implementation details of the processor system. That said, the Nios II processors are designed for Altera field programmable gate array (FPGA) devices, and so this handbook does describe some FPGA implementation concepts. Your familiarity with FPGA technology provides a deeper understanding of the engineering trade-offs related to the design and implementation of the Nios II processor.

This *Introduction* chapter introduces the Altera® Nios® II embedded processor family. The chapter helps hardware and software engineers understand the similarities and differences between the Nios II processor and traditional embedded processors. This chapter contains the following sections:

- “Nios II Processor System Basics” on page 1–1
- “Getting Started with the Nios II Processor” on page 1–2
- “Customizing Nios II Processor Designs” on page 1–3
- “Configurable Soft-Core Processor Concepts” on page 1–4
- “OpenCore Plus Evaluation” on page 1–5

Nios II Processor System Basics

The Nios II processor is a general-purpose RISC processor core, providing:

- Full 32-bit instruction set, data path, and address space
- 32 general-purpose registers
- 32 external interrupt sources
- Single-instruction 32×32 multiply and divide producing a 32-bit result
- Dedicated instructions for computing 64-bit and 128-bit products of multiplication
- Floating-point instructions for single-precision floating-point operations

- Single-instruction barrel shifter
- Access to a variety of on-chip peripherals, and interfaces to off-chip memories and peripherals
- Hardware-assisted debug module enabling processor start, stop, step, and trace under integrated development environment (IDE) control
- Optional memory management unit (MMU) to support operating systems that require MMUs
- Optional memory protection unit (MPU)
- Software development environment based on the GNU C/C++ tool chain and Eclipse IDE
- Integration with Altera's SignalTap® II Embedded Logic Analyzer, enabling real-time analysis of instructions and data along with other signals in the FPGA design
- Instruction set architecture (ISA) compatible across all Nios II processor systems
- Performance up to 250 DMIPS

A Nios II processor system is equivalent to a microcontroller or “computer on a chip” that includes a processor and a combination of peripherals and memory on a single chip. A Nios II processor system consists of a Nios II processor core, a set of on-chip peripherals, on-chip memory, and interfaces to off-chip memory, all implemented on a single Altera device. Like a microcontroller family, all Nios II processor systems use a consistent instruction set and programming model.

Getting Started with the Nios II Processor

Getting started with the Nios II processor is similar to any other microcontroller family. The easiest way to start designing effectively is to purchase a development kit from Altera that includes a ready-made evaluation board and the Nios II Embedded Design Suite (EDS) containing all the software development tools necessary to write Nios II software.

The Nios II EDS contains the Nios II integrated development environment or Nios II IDE. The Nios II IDE is based on the GNU C/C++ compiler and the Eclipse IDE, and provides a familiar and established environment for software development. Using the Nios II IDE, you can immediately begin developing and simulating Nios II software applications.

The Nios II EDS also contains the Nios II software build tools. The Nios II software build tools provide a command line interface.

Using the Nios II hardware reference designs included in an Altera development kit, you can prototype an application running on a board before building a custom hardware platform. [Figure 1-1](#) shows an example of a Nios II processor reference design available in an Altera Nios II development kit.

Figure 1-1. Example of a Nios II Processor System

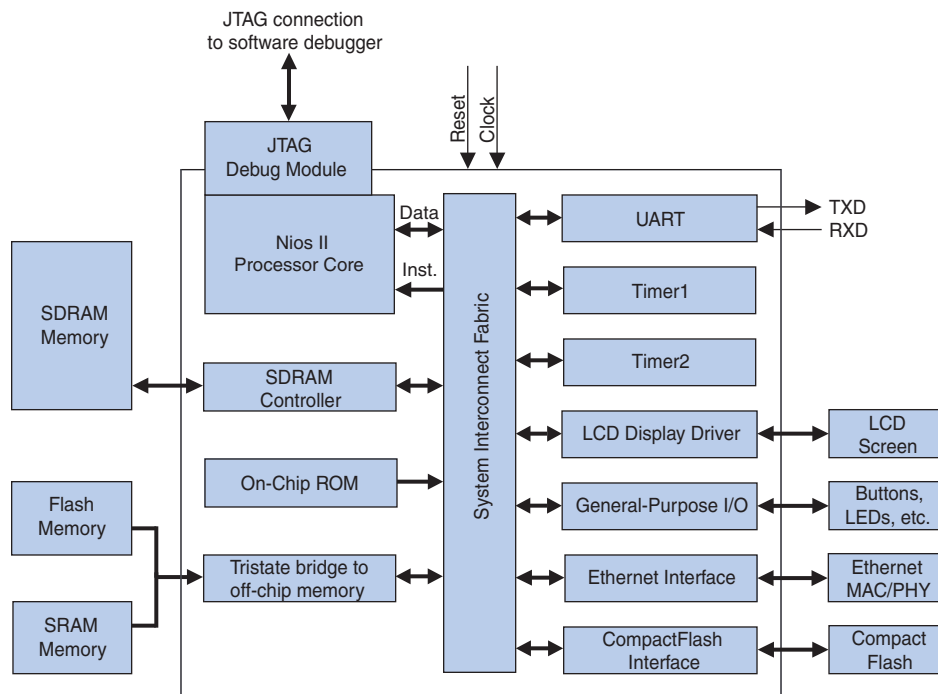

If the prototype system adequately meets design requirements using an Altera-provided reference design, you can copy the reference design and use it as is in the final hardware platform. Otherwise, you can customize the Nios II processor system until it meets cost or performance requirements.

Customizing Nios II Processor Designs

In practice, most FPGA designs implement some extra logic in addition to the processor system. Altera FPGAs provide flexibility to add features and enhance performance of the Nios II processor system. Conversely, you can eliminate unnecessary processor features and peripherals to fit the design in a smaller, lower-cost device.

Because the pins and logic resources in Altera devices are programmable, many customizations are possible:

- You can rearrange the pins on the chip to simplify the board design. For example, you can move address and data pins for external SDRAM memory to any side of the chip to shorten board traces.
- You can use extra pins and logic resources on the chip for functions unrelated to the processor. Extra resources can provide a few extra gates and registers as glue logic for the board design; or extra resources can implement entire systems. For example, a Nios II processor system consumes only 5% of a large Altera FPGA, leaving the rest of the chip's resources available to implement other functions.
- You can use extra pins and logic on the chip to implement additional peripherals for the Nios II processor system. Altera offers a library of peripherals that easily connect to Nios II processor systems.

Configurable Soft-Core Processor Concepts

This section introduces Nios II concepts that are unique or different from other discrete microcontrollers. The concepts described in this section provide a foundation for understanding the rest of the features discussed in this document.

For the most part, these concepts relate to the flexibility available to hardware designers to fine tune system implementation. Software programmers generally are not affected by the hardware implementation details, and can write programs without awareness of the configurable nature of the Nios II processor core.

Configurable Soft-Core Processor

The Nios II processor is a configurable soft-core processor, as opposed to a fixed, off-the-shelf microcontroller. In this context, configurable means that you can add or remove features on a system-by-system basis to meet performance or price goals. Soft-core means the processor core is not fixed in silicon and can be targeted to any Altera FPGA family.

Configurability does not require you to create a new Nios II processor configuration for every new design. Altera provides ready-made Nios II system designs that you can use as is. If these designs meet your system requirements, there is no need to configure the design further. In addition, software designers can use the Nios II instruction set simulator to begin writing and debugging Nios II applications before the final hardware configuration is determined.

Flexible Peripheral Set and Address Map

A flexible peripheral set is one of the most notable differences between Nios II processor systems and fixed microcontrollers. Because of the soft-core nature of the Nios II processor, you can easily build made-to-order Nios II processor systems with the exact peripheral set required for the target applications.

A corollary of flexible peripherals is a flexible address map. Altera provides software constructs to access memory and peripherals generically, independently of address location. Therefore, the flexible peripheral set and address map does not affect application developers.

There are two broad classes of peripherals: standard peripherals and custom peripherals.

Standard Peripherals

Altera provides a set of peripherals commonly used in microcontrollers, such as timers, serial communication interfaces, general-purpose I/O, SDRAM controllers, and other memory interfaces. The list of available peripherals continues to grow as Altera and third-party vendors release new soft-peripheral cores.



For details on the Altera-provided cores, refer to *Volume 5: Embedded Peripherals* of the *Quartus II Handbook*.

Custom Peripherals

You can also create custom peripherals and integrate them in Nios II processor systems. For performance-critical systems that spend most CPU cycles executing a specific section of code, it is a common technique to create a custom peripheral that implements the same function in hardware. This approach offers a double performance benefit: the hardware implementation is faster than software; and the processor is free to perform other functions in parallel while the custom peripheral operates on data.



For details on creating custom peripherals, refer to the *SOPC Builder Components* chapter in volume 4 of the *Quartus II Handbook*.

Custom Instructions

Like custom peripherals, custom instructions allow you to increase system performance by augmenting the processor with custom hardware. The soft-core nature of the Nios II processor enables you to integrate custom logic into the arithmetic logic unit (ALU). Similar to native Nios II instructions, custom instruction logic can take values from up to two source registers and optionally write back a result to a destination register.

Because the processor is implemented on reprogrammable Altera FPGAs, software and hardware engineers can work together to iteratively optimize the hardware and test the results of software running on hardware.

From the software perspective, custom instructions appear as machine-generated assembly macros or C functions, so programmers do not need to understand assembly language to use custom instructions.

Automated System Generation

Altera's SOPC Builder design tool fully automates the process of configuring processor features and generating a hardware design that you program in an FPGA. The SOPC Builder graphical user interface (GUI) enables you to configure Nios II processor systems with any number of peripherals and memory interfaces. You can create entire processor systems without performing any schematic or hardware description-language (HDL) design entry. SOPC Builder can also import HDL design files, providing an easy mechanism to integrate custom logic in a Nios II processor system.

After system generation, you can download the design onto a board, and debug software executing on the board. To the software developer, the processor architecture of the design is set. Software development proceeds in the same manner as for traditional, non-configurable processors.

OpenCore Plus Evaluation

You can evaluate the Nios II processor without a license. With Altera's free OpenCore Plus evaluation feature, you can perform the following actions:

- Simulate the behavior of a Nios II processor within your system
- Verify the functionality of your design, as well as evaluate its size and speed quickly and easily

- Generate time-limited device programming files for designs that include Nios II processors
- Program a device and verify your design in hardware

You only need to purchase a license for the Nios II processor when you are completely satisfied with its functionality and performance, and want to take your design to production.

 For more information about OpenCore Plus, refer to [AN 320: OpenCore Plus Evaluation of Megafunctions](#).

Referenced Documents

This chapter references the following documents:

- [Volume 5: Embedded Peripherals](#) of the *Quartus II Handbook*
- [SOPC Builder Components](#) chapter in volume 4 of the *Quartus II Handbook*
- [AN 320: OpenCore Plus Evaluation of Megafunctions](#)
- [Literature: Nios II Processor](#) page on the Altera website

Document Revision History

[Table 1-1](#) shows the revision history for this document.

Table 1-1. Document Revision History (Part 1 of 2)

Date & Document Version	Changes Made	Summary of Changes
March 2009 v9.0.0	Maintenance release.	—
November 2008 v8.1.0	Maintenance release.	—
May 2008 v8.0.0	Added MMU and MPU to bullet list of features.	Added MMU and MPU.
October 2007 v7.2.0	Added OpenCore Plus section.	—
May 2007 v7.1.0	<ul style="list-style-type: none"> ■ Added table of contents to Introduction section. ■ Added Referenced Documents section. 	—
March 2007 v7.0.0	Maintenance release.	—
November 2006 v6.1.0	Maintenance release.	—
May 2006 v6.0.0	<ul style="list-style-type: none"> ■ Added single precision floating-point and integration with SignalTap® II logic analyzer to features list. ■ Updated performance to 250 DMIPS. 	—

Table 1-1. Document Revision History (Part 2 of 2)

Date & Document Version	Changes Made	Summary of Changes
October 2005 v5.1.0	Maintenance release.	—
May 2005 v5.0.0	Maintenance release.	—
September 2004 v1.1	Updates for Nios II 1.01 release.	—
May 2004 v1.0	Initial release.	—

Introduction

This chapter describes the hardware structure of the Nios® II processor, including a discussion of all the functional units of the Nios II architecture and the fundamentals of the Nios II processor hardware implementation. This chapter contains the following sections:

- “Processor Implementation” on page 2–3
- “Register File” on page 2–3
- “Arithmetic Logic Unit” on page 2–3
- “Reset and Debug Signals” on page 2–7
- “Exception and Interrupt Controller” on page 2–7
- “Memory and I/O Organization” on page 2–9
- “JTAG Debug Module” on page 2–16

The Nios II architecture describes an instruction set architecture (ISA). The ISA in turn necessitates a set of functional units that implement the instructions. A Nios II processor core is a hardware design that implements the Nios II instruction set and supports the functional units described in this document. The processor core does not include peripherals or the connection logic to the outside world. It includes only the circuits required to implement the Nios II architecture.

Figure 2–1 shows a block diagram of the Nios II processor core.

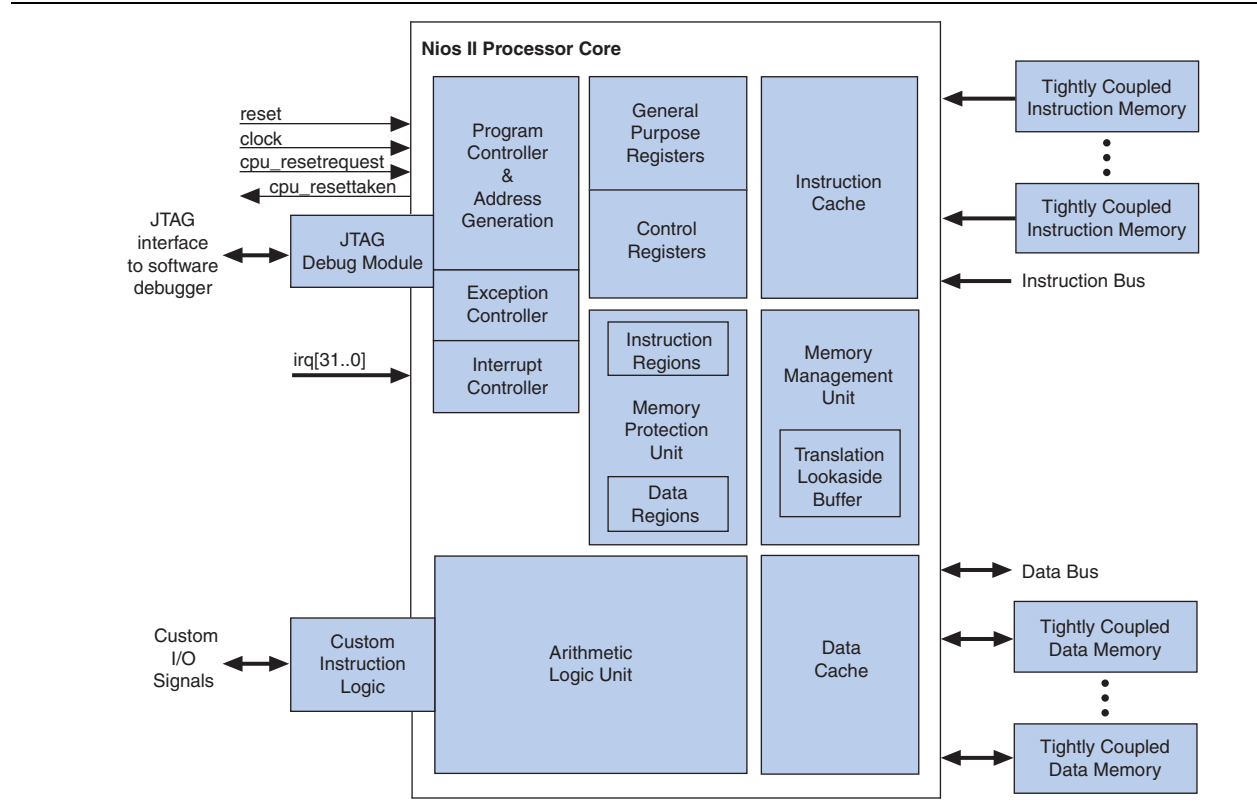
Figure 2-1. Nios II Processor Core Block Diagram

The Nios II architecture defines the following functional units:

- Register file
- Arithmetic logic unit (ALU)
- Interface to custom instruction logic
- Exception controller
- Interrupt controller
- Instruction bus
- Data bus
- Memory management unit (MMU)
- Memory protection unit (MPU)
- Instruction and data cache memories
- Tightly-coupled memory interfaces for instructions and data
- JTAG debug module

The following sections discuss hardware implementation details related to each functional unit.

Processor Implementation

The functional units of the Nios II architecture form the foundation for the Nios II instruction set. However, this does not indicate that any unit is implemented in hardware. The Nios II architecture describes an instruction set, not a particular hardware implementation. A functional unit can be implemented in hardware, emulated in software, or omitted entirely.

A Nios II implementation is a set of design choices embodied by a particular Nios II processor core. All implementations support the instruction set defined in the *Instruction Set Reference* chapter of the *Nios II Processor Reference Handbook*. Each implementation achieves specific objectives, such as smaller core size or higher performance. This allows the Nios II architecture to adapt to the needs of different target applications.

Implementation variables generally fit one of three trade-off patterns: more-or-less of a feature; inclusion-or-exclusion of a feature; hardware implementation or software emulation of a feature. An example of each trade-off follows:

- More or less of a feature—For example, to fine-tune performance, you can increase or decrease the amount of instruction cache memory. A larger cache increases execution speed of large programs, while a smaller cache conserves on-chip memory resources.
- Inclusion or exclusion of a feature—For example, to reduce cost, you can choose to omit the JTAG debug module. This decision conserves on-chip logic and memory resources, but it eliminates the ability to use a software debugger to debug applications.
- Hardware implementation or software emulation—For example, in control applications that rarely perform complex arithmetic, you can choose for the division instruction to be emulated in software. Removing the divide hardware conserves on-chip resources but increases the execution time of division operations.

 For details of which Nios II cores supports what features, refer to the *Nios II Core Implementation Details* chapter of the *Nios II Processor Reference Handbook*. For complete details of user-selectable parameters for the Nios II processor, refer to the *Instantiating the Nios II Processor in SOPC Builder* chapter of the *Nios II Processor Reference Handbook*.

Register File

The Nios II architecture supports a flat register file, consisting of thirty two 32-bit general-purpose integer registers, and up to thirty two 32-bit control registers. The architecture supports supervisor and user modes that allow system code to protect the control registers from errant applications.

The Nios II architecture allows for the future addition of floating-point registers.

Arithmetic Logic Unit

The Nios II ALU operates on data stored in general-purpose registers. ALU operations take one or two inputs from registers, and store a result back in a register. The ALU supports the data operations shown in [Table 2-1](#).

Table 2-1. Operations Supported by the Nios II ALU

Category	Details
Arithmetic	The ALU supports addition, subtraction, multiplication, and division on signed and unsigned operands.
Relational	The ALU supports the equal, not-equal, greater-than-or-equal, and less-than relational operations (==, != >=, <) on signed and unsigned operands.
Logical	The ALU supports AND, OR, NOR, and XOR logical operations.
Shift and Rotate	The ALU supports shift and rotate operations, and can shift/rotate data by 0 to 31 bit positions per instruction. The ALU supports arithmetic shift right and logical shift right/left. The ALU supports rotate left/right.

To implement any other operation, software computes the result by performing a combination of the fundamental operations in [Table 2-1](#).

Unimplemented Instructions

Some Nios II processor core implementations do not provide hardware to support the entire Nios II instruction set. In such a core, instructions without hardware support are known as unimplemented instructions.

The processor generates an exception whenever it issues an unimplemented instruction so your exception handler can call a routine that emulates the operation in software. Therefore, unimplemented instructions do not affect the programmer's view of the processor.

 For a list of potential unimplemented instructions, refer to the *Programming Model* chapter of the *Nios II Processor Reference Handbook*.

Custom Instructions

The Nios II architecture supports user-defined custom instructions. The Nios II ALU connects directly to custom instruction logic, enabling you to implement in hardware operations that are accessed and used exactly like native instructions.

 For further information, refer to the *Nios II Custom Instruction User Guide*.

Floating-Point Instructions

The Nios II architecture supports single precision floating-point instructions as specified by the IEEE Std 754-1985. The basic set of floating-point custom instructions includes single precision floating-point addition, subtraction, and multiplication. Floating-point division is available as an extension to the basic instruction set. These floating-point instructions are implemented as custom instructions. [Table 2-2](#) provides a detailed description of the conformance to IEEE 754-1985.

Table 2-2. Hardware Conformance with IEEE 754-1985 Floating-Point Standard

Feature		Implementation
Operations (1)	Addition	Implemented
	Subtraction	Implemented
	Multiplication	Implemented
	Division	Optional
Precision	Single	Implemented
	Double	Not implemented. Double precision operations are implemented in software.
Exception conditions	Invalid operation	Result is Not a Number (NaN)
	Division by zero	Result is \pm infinity
	Overflow	Result is \pm infinity
	Inexact	Result is a normal number
	Underflow	Result is ± 0
Rounding Modes	Round to nearest	Implemented
	Round toward zero	Not implemented
	Round toward +infinity	Not implemented
	Round toward -infinity	Not implemented
NaN	Quiet	Implemented
	Signaling	Not implemented
Subnormal (denormalized) numbers		Subnormal operands are treated as zero. The floating-point custom instructions do not generate subnormal numbers.
Software exceptions		Not implemented. IEEE 754-1985 exception conditions are detected and handled as shown elsewhere in this table.
Status flags		Not implemented. IEEE 754-1985 exception conditions are detected and handled as shown elsewhere in this table.

Notes to Table 2-2:

- (1) The Nios II Embedded Design Suite (EDS) provides software implementations of primitive floating-point operations other than addition, subtraction, multiplication, and division. This includes operations such as floating-point conversions and comparisons. The software implementations of these primitives are 100% compliant with IEEE 754-1985.

You can add floating-point custom instructions to any Nios II processor core using the Nios II Processor MegaWizard interface. The floating-point division hardware requires more resources than the other instructions. The MegaWizard interface allows you to omit the floating-point division hardware for cases in which code running on your hardware design does not make heavy use of floating-point division. When you omit the floating-point divide instruction, the Nios II compiler implements floating-point division in software.

 To add floating-point custom instructions to your Nios II processor core, refer to “Custom Instructions Page” in the *Instantiating the Nios II Processor in SOPC Builder* chapter of the *Nios II Processor Reference Handbook*.

The Nios II floating-point custom instructions are based on the Altera floating-point megafunctions.

 For details on each individual floating-point megafunction, including acceleration factors and device resource usage, refer to the [Literature: Megafunctions](#) page on the Altera website.

The Nios II software development tools recognize C code that takes advantage of the floating-point instructions present in the processor core. When the floating-point custom instructions are present in your target hardware, the Nios II compiler compiles your code to use the custom instructions for floating-point operations, including addition, subtraction, multiplication, division and the newlib math library.

Software Development Considerations

The best choice for your hardware design depends on a balance among floating-point usage, hardware resource usage, and performance. While the floating-point custom instructions speed up floating-point arithmetic, they substantially add to the size of your hardware design. If resource usage is an issue, consider reworking your algorithms to minimize floating-point arithmetic.

You can use `#pragma` directives in your software to compare hardware and software implementations of the floating-point instructions. The following `#pragma` directives instruct the Nios II compiler to ignore the floating-point instructions and generate software implementations. The scope of these `#pragma` directives is the entire C file.

- `#pragma no_custom_fadds`—Forces software implementation of floating-point add
- `#pragma no_custom_fsubs`—Forces software implementation of floating-point subtract
- `#pragma no_custom_fmuls`—Forces software implementation of floating-point multiply
- `#pragma no_custom_fdivs`—Forces software implementation of floating-point divide

 The Nios II instruction set simulator (ISS) does not support custom instructions. If you need to run your software on the ISS, disable the floating-point custom instructions in software with the `#pragma` directives.

All the floating-point custom instructions are single-precision operations. Double-precision operations are implemented in software. By default, the Nios II compiler treats floating-point constants as double-precision numbers. To use the floating-point custom instructions for operations with floating-point constants, append an “f” to the constant. This tells the compiler to treat the constant as a single-precision floating-point value, rather than promote the other variables in your equation to double precision numbers. [Table 2-3](#) shows code examples using constants.

Table 2-3. Floating-Point Constant Examples

Example Code	Precision	Floating-Point Custom Instruction Usage
<code>y = x × 4.67;</code>	Double	No
<code>y = x × 4.67f;</code>	Single	Yes

Reset and Debug Signals

The Nios II processor core supports the following two kinds of reset signals:

- `reset`—This is a global hardware reset signal that forces the processor core to reset immediately.
- `cpu_resetrequest`—This is an optional, local reset signal that causes the processor to reset without affecting other components in the Nios II system. The processor finishes executing any instructions in the pipeline, and then enters the reset state. This process can take several clock cycles, so be sure to continue asserting the `cpu_resetrequest` signal until the processor core asserts a `cpu_resettaken` signal.

The processor core asserts a `cpu_resettaken` signal for 1 cycle when the reset is complete and then periodically if `cpu_resetrequest` remains asserted. The processor remains in the reset state for as long as `cpu_resetrequest` is asserted. While the processor is in the reset state, it periodically reads from the reset address. It discards the result of the read, and remains in the reset state.

The processor does not respond to `cpu_resetrequest` when the processor is under the control of the JTAG debug module, that is, when the processor is paused. The processor responds to the `cpu_resetrequest` signal if the signal is asserted when the JTAG debug module relinquishes control, both momentarily during each single step as well as when you resume execution.

 For more information on adding reset signals to the Nios II processor, refer to “Advanced Features Page” in the *Instantiating the Nios II Processor in SOPC Builder* chapter of the *Nios II Processor Reference Handbook*.

The Nios II processor core also supports debug signals.

- `debugreq`—This is an optional signal that temporarily suspends the processor for debugging purposes. When you assert the signal, the processor pauses in the same manner as when a breakpoint is encountered, transfers execution to the routine located at the break address, and asserts a `debugack` signal. Asserting the `debugreq` signal when the processor is already paused has no effect.

 For more information on the break vector and adding debug signals to the Nios II processor, refer to “JTAG Debug Module Page” in the *Instantiating the Nios II Processor in SOPC Builder* chapter of the *Nios II Processor Reference Handbook*.

Exception and Interrupt Controller

Exception Controller

The Nios II architecture provides a simple, non-vectorized exception controller to handle all exception types. Each exception, including hardware interrupts, causes the processor to transfer execution to an exception address. An exception handler at this address determines the cause of the exception and dispatches an appropriate exception routine.

Exception addresses are specified in SOPC Builder at system generation time.

All exceptions are precise. Precise means that the processor has completed execution of all instructions preceding the faulting instruction and not started execution of instructions following the faulting instruction. Precise exceptions allow the processor to resume program execution once the exception handler clears the exception.

Integral Interrupt Controller

The Nios II architecture supports 32 external hardware interrupts. The processor core has 32 level-sensitive interrupt request (IRQ) inputs, `irq0` through `irq31`, providing a unique input for each interrupt source. IRQ priority is determined by software. The architecture supports nested interrupts.

The software can enable and disable any interrupt source individually through the `ienable` control register, which contains an interrupt-enable bit for each of the IRQ inputs. Software can enable and disable interrupts globally using the PIE bit of the `status` control register. A hardware interrupt is generated if and only if all of the following conditions are true:

- The PIE bit of the `status` register is 1
- An interrupt-request input, `irq<n>`, is asserted
- The corresponding bit `n` of the `ienable` register is 1

Interrupt Vector Custom Instruction

The Nios II processor core offers an interrupt vector custom instruction which accelerates interrupt vector dispatch. Include this custom instruction to reduce your program's interrupt latency.

The interrupt vector custom instruction is based on a priority encoder with one input for each interrupt connected to the Nios II processor. The cost of the interrupt vector custom instruction depends on the number of interrupts connected to the Nios II processor. The worst case is a system with 32 interrupts. In this case, the interrupt vector custom instruction consumes about 50 logic elements (LEs).

If you have a large number of interrupts connected, adding the interrupt vector custom instruction to your system might lower f_{MAX} .



For guidance in adding the interrupt vector custom instruction to the Nios II processor, refer to the *Instantiating the Nios II Processor in SOPC Builder* chapter of the *Nios II Processor Reference Handbook*.

Table 2-4 details the implementation of the interrupt vector custom instruction.

Table 2-4. Interrupt Vector Custom Instruction (Part 1 of 2)

`ALT_CI_EXCEPTION_VECTOR_N`

Operation: if (`ipending == 0`) | (`estatus.PIE == 0`)
 then `rC` ← negative value
 else `rC` ← $8 \times$ bit # of the least-significant 1 bit of the `ipending` register (`ct14`)

Assembler Syntax: custom `ALT_CI_EXCEPTION_VECTOR_N, rC, r0, r0`

Example: custom `ALT_CI_EXCEPTION_VECTOR_N, et, r0, r0`
 blt `et, r0, not_irq`

Table 2-4. Interrupt Vector Custom Instruction (Part 2 of 2)

Description:	The interrupt vector custom instruction accelerates interrupt vector dispatch. This custom instruction identifies the highest priority interrupt, generates the vector table offset, and stores this offset to rC. The instruction generates a negative offset if there is no hardware interrupt (that is, the exception is caused by a software condition, such as a trap).
Usage:	The interrupt vector custom instruction is used exclusively by the exception handler.
Exceptions:	None
Instruction Type:	R
Instruction Fields:	C = Register index of operand rC N = Value of ALT_CI_EXCEPTION_VECTOR_N

31	30	29	28	27	26	25	24	23	22	21	20	19	18	17	16	15	14	13	12	11	10	9	8	7	6	5	4	3	2	1	0
0				0				C				0	0	1	N								0x32								

 For an explanation of the instruction reference format, refer to the *Instruction Set Reference* chapter of the *Nios II Processor Reference Handbook*.

Memory and I/O Organization

This section explains hardware implementation details of the Nios II memory and I/O organization. The discussion covers both general concepts true of all Nios II processor systems, as well as features that might change from system to system.

The flexible nature of the Nios II memory and I/O organization are the most notable difference between Nios II processor systems and traditional microcontrollers. Because Nios II processor systems are configurable, the memories and peripherals vary from system to system. As a result, the memory and I/O organization varies from system to system.

A Nios II core uses one or more of the following to provide memory and I/O access:

- Instruction master port—An Avalon® Memory-Mapped (Avalon-MM) master port that connects to instruction memory via system interconnect fabric
- Instruction cache—Fast cache memory internal to the Nios II core
- Data master port—An Avalon-MM master port that connects to data memory and peripherals via system interconnect fabric
- Data cache—Fast cache memory internal to the Nios II core
- Tightly-coupled instruction or data memory port—Interface to fast on-chip memory outside the Nios II core

The Nios II architecture hides the hardware details from the programmer, so programmers can develop Nios II applications without specific knowledge of the hardware implementation.

 For details that affect programming issues, refer to the *Programming Model* chapter of the *Nios II Processor Reference Handbook*.

Figure 2-2 shows a diagram of the memory and I/O organization for a Nios II processor core.

Figure 2-2. Nios II Memory and I/O Organization

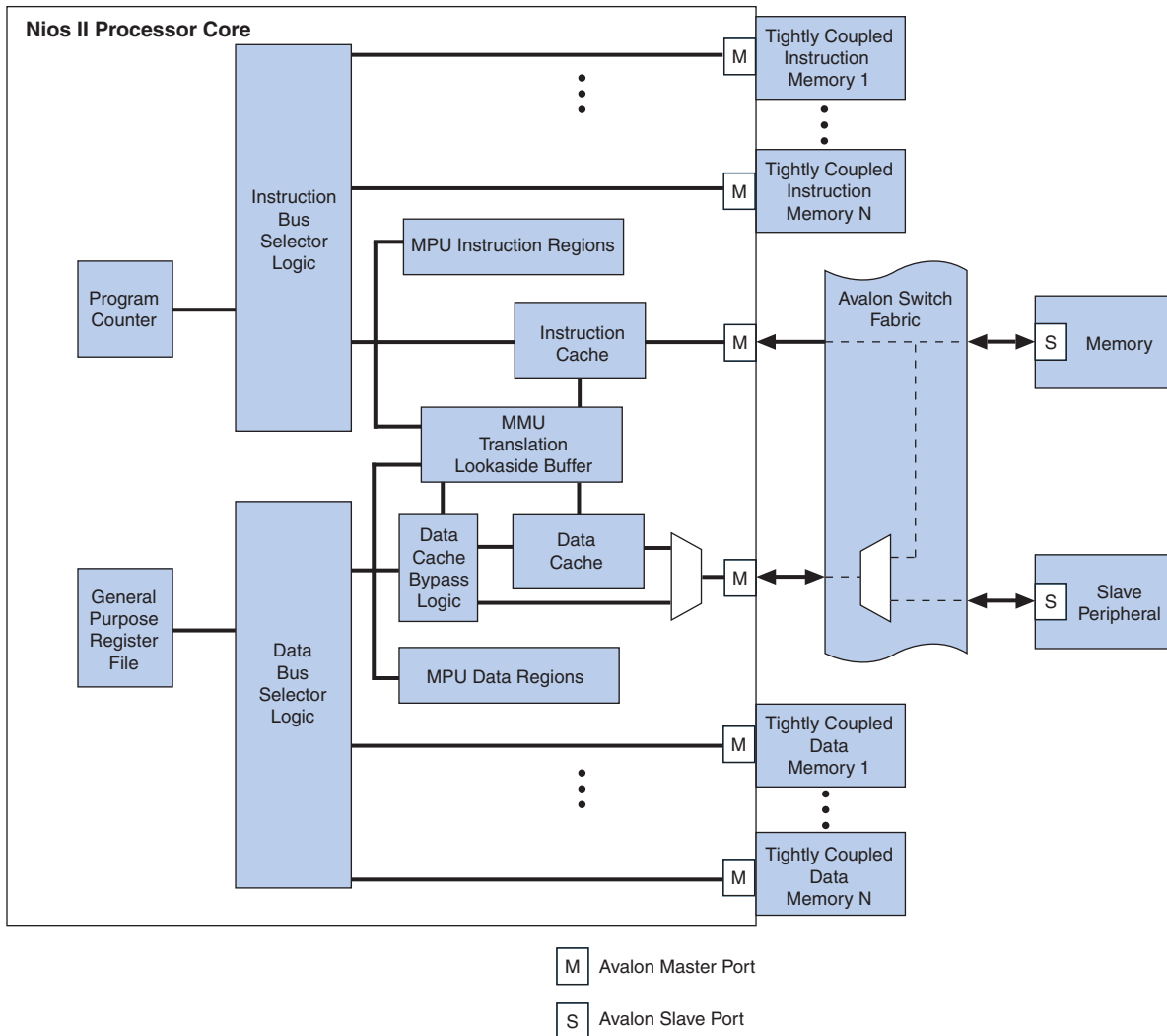

Instruction and Data Buses

The Nios II architecture supports separate instruction and data buses, classifying it as a Harvard architecture. Both the instruction and data buses are implemented as Avalon-MM master ports that adhere to the Avalon-MM interface specification. The data master port connects to both memory and peripheral components, while the instruction master port connects only to memory components.

 Refer to the *Avalon Interface Specifications* for details of the Avalon-MM interface.

Memory and Peripheral Access

The Nios II architecture provides memory-mapped I/O access. Both data memory and peripherals are mapped into the address space of the data master port. The Nios II architecture is little endian. Words and halfwords are stored in memory with the more-significant bytes at higher addresses.

The Nios II architecture does not specify anything about the existence of memory and peripherals; the quantity, type, and connection of memory and peripherals are system-dependent. Typically, Nios II processor systems contain a mix of fast on-chip memory and slower off-chip memory. Peripherals typically reside on-chip, although interfaces to off-chip peripherals also exist.

Instruction Master Port

The Nios II instruction bus is implemented as a 32-bit Avalon-MM master port. The instruction master port performs a single function: it fetches instructions to be executed by the processor. The instruction master port does not perform any write operations.

The instruction master port is a pipelined Avalon-MM master port. Support for pipelined Avalon-MM transfers minimizes the impact of synchronous memory with pipeline latency and increases the overall f_{MAX} of the system. The instruction master port can issue successive read requests before data has returned from prior requests. The Nios II processor can prefetch sequential instructions and perform branch prediction to keep the instruction pipe as active as possible.

The instruction master port always retrieves 32 bits of data. The instruction master port relies on dynamic bus-sizing logic contained in the system interconnect fabric. By virtue of dynamic bus sizing, every instruction fetch returns a full instruction word, regardless of the width of the target memory. Consequently, programs do not need to be aware of the widths of memory in the Nios II processor system.

The Nios II architecture supports on-chip cache memory for improving average instruction fetch performance when accessing slower memory. Refer to [“Cache Memory” on page 2-12](#) for details. The Nios II architecture supports tightly-coupled memory, which provides guaranteed low-latency access to on-chip memory. Refer to [“Tightly-Coupled Memory” on page 2-13](#) for details.

Data Master Port

The Nios II data bus is implemented as a 32-bit Avalon-MM master port. The data master port performs two functions:

- Read data from memory or a peripheral when the processor executes a load instruction
- Write data to memory or a peripheral when the processor executes a store instruction

Byte-enable signals on the master port specify which of the four byte-lane(s) to write during store operations. When the Nios II core is configured with a data cache line size greater than four bytes, the data master port supports pipelined Avalon-MM transfers. When the data cache line size is only four bytes, any memory pipeline latency is perceived by the data master port as wait states. Load and store operations can complete in a single clock-cycle when the data master port is connected to zero-wait-state memory.

The Nios II architecture supports on-chip cache memory for improving average data transfer performance when accessing slower memory. Refer to “[Cache Memory](#)” on page 2-12 for details. The Nios II architecture supports tightly-coupled memory, which provides guaranteed low-latency access to on-chip memory. Refer to “[Tightly-Coupled Memory](#)” on page 2-13 for details.

Shared Memory for Instructions and Data

Usually the instruction and data master ports share a single memory that contains both instructions and data. While the processor core has separate instruction and data buses, the overall Nios II processor system might present a single, shared instruction/data bus to the outside world. The outside view of the Nios II processor system depends on the memory and peripherals in the system and the structure of the system interconnect fabric.

The data and instruction master ports never cause a gridlock condition in which one port starves the other. For highest performance, assign the data master port higher arbitration priority on any memory that is shared by both instruction and data master ports.

Cache Memory

The Nios II architecture supports cache memories on both the instruction master port (instruction cache) and the data master port (data cache). Cache memory resides on-chip as an integral part of the Nios II processor core. The cache memories can improve the average memory access time for Nios II processor systems that use slow off-chip memory such as SDRAM for program and data storage.

The instruction and data caches are enabled perpetually at run-time, but methods are provided for software to bypass the data cache so that peripheral accesses do not return cached data. Cache management and cache coherency are handled by software. The Nios II instruction set provides instructions for cache management.

Configurable Cache Memory Options

The cache memories are optional. The need for higher memory performance (and by association, the need for cache memory) is application dependent. Many applications require the smallest possible processor core, and can trade-off performance for size.

A Nios II processor core might include one, both, or neither of the cache memories. Furthermore, for cores that provide data and/or instruction cache, the sizes of the cache memories are user-configurable. The inclusion of cache memory does not affect the functionality of programs, but it does affect the speed at which the processor fetches instructions and reads/writes data.

Effective Use of Cache Memory

The effectiveness of cache memory to improve performance is based on the following premises:

- Regular memory is located off-chip, and access time is long compared to on-chip memory
- The largest, performance-critical instruction loop is smaller than the instruction cache
- The largest block of performance-critical data is smaller than the data cache

Optimal cache configuration is application specific, although you can make decisions that are effective across a range of applications. For example, if a Nios II processor system includes only fast, on-chip memory (i.e., it never accesses slow, off-chip memory), an instruction or data cache is unlikely to offer any performance gain. As another example, if the critical loop of a program is 2 KBytes, but the size of the instruction cache is 1 KByte, an instruction cache does not improve execution speed. In fact, an instruction cache may degrade performance in this situation.

If an application always requires certain data or sections of code to be located in cache memory for performance reasons, the tightly-coupled memory feature might provide a more appropriate solution. Refer to “[Tightly-Coupled Memory](#)” on page 2-13 for details.

Cache Bypass Methods

The Nios II architecture provides the following methods for bypassing the data cache:

- I/O load and store instructions
- Bit-31 cache bypass

I/O Load and Store Instructions Method

The load and store I/O instructions such as `ldio` and `stio` bypass the data cache and force an Avalon-MM data transfer to a specified address.

The Bit-31 Cache Bypass Method

The bit-31 cache bypass method on the data master port uses bit 31 of the address as a tag that indicates whether the processor should transfer data to/from cache, or bypass it. This is a convenience for software, which might need to cache certain addresses and bypass others. Software can pass addresses as parameters between functions, without having to specify any further information about whether the addressed data is cached or not.



To determine which cores implement which cache bypass methods, refer to the [Nios II Core Implementation Details](#) chapter of the *Nios II Processor Reference Handbook*.

Tightly-Coupled Memory

Tightly-coupled memory provides guaranteed low-latency memory access for performance-critical applications. Compared to cache memory, tightly-coupled memory provides the following benefits:

- Performance similar to cache memory
- Software can guarantee that performance-critical code or data is located in tightly-coupled memory
- No real-time caching overhead, such as loading, invalidating, or flushing memory

Physically, a tightly-coupled memory port is a separate master port on the Nios II processor core, similar to the instruction or data master port. A Nios II core can have zero, one, or multiple tightly-coupled memories. The Nios II architecture supports tightly-coupled memories for both instruction and data access. Each tightly-coupled memory port connects directly to exactly one memory with guaranteed low, fixed latency. The memory is external to the Nios II core and is usually located on chip.

Accessing Tightly-Coupled Memory

Tightly-coupled memories occupy normal address space, the same as other memory devices connected via system interconnect fabric. The address ranges for tightly-coupled memories (if any) are determined at system generation time.

Software accesses tightly-coupled memory using regular load and store instructions. From the software's perspective, there is no difference accessing tightly-coupled memory compared to other memory.

Effective Use of Tightly-Coupled Memory

A system can use tightly-coupled memory to achieve maximum performance for accessing a specific section of code or data. For example, interrupt-intensive applications can place exception handler code into a tightly-coupled memory to minimize interrupt latency. Similarly, compute-intensive digital signal processing (DSP) applications can place data buffers into tightly-coupled memory for the fastest possible data access.

If the application's memory requirements are small enough to fit entirely on chip, it is possible to use tightly-coupled memory exclusively for code and data. Larger applications must selectively choose what to include in tightly-coupled memory to maximize the cost-performance trade-off.

Address Map

The address map for memories and peripherals in a Nios II processor system is design dependent. You specify the address map at system generation time.

There are three addresses that are part of the processor and deserve special mention:

- Reset address
- Exception address
- Break handler address

Programmers access memories and peripherals by using macros and drivers. Therefore, the flexible address map does not affect application developers.

Memory Management Unit

The optional Nios II MMU provides the following features and functionality:

- Virtual to physical address mapping
- Memory protection
- 32-bit virtual and physical addresses, mapping a 4 GByte virtual address space into as much as 4 GBytes of physical memory
- 4 KByte page and frame size
- Low 512 MBytes of physical address space available for direct access

- Hardware translation lookaside buffers (TLBs), accelerating address translation
 - Separate TLBs for instruction and data accesses
 - Read, write, and execute permissions controlled per page
 - Default caching behavior controlled per page
 - TLBs acting as n -way set-associative caches for software page tables
 - TLB sizes and associativities configurable at system generation
- Format of page tables (or equivalent data structures) determined by system software
- Replacement policy for TLB entries determined by system software
- Write policy for TLB entries determined by system software
- All exceptions precise

 For further details on the MMU implementation, refer to the *Programming Model* chapter of the *Nios II Processor Reference Handbook*.

You can optionally include the MMU when you instantiate the Nios II processor in your Nios II hardware system. When present, the MMU is always enabled, and the data and instruction caches are virtually-indexed, physically-tagged caches. Several parameters are available, allowing you to optimize the MMU for your system needs.

For complete details of user-selectable parameters for the Nios II MMU, refer to the *Instantiating the Nios II Processor in SOPC Builder* chapter of the *Nios II Processor Reference Handbook*.

 The Nios II MMU is optional and mutually exclusive from the Nios II MPU. Nios II systems can include either an MMU or MPU, but cannot include both an MMU and MPU in the same design.

Memory Protection Unit

The optional Nios II MPU provides the following features and functionality:

- Memory protection
- Up to 32 instruction regions and 32 data regions
- Variable instruction and data region sizes
- Amount of region memory defined by size or upper address limit
- Read and write access permissions for data regions
- Execute access permissions for instruction regions
- Overlapping regions
- All exceptions precise

 For further details on the MPU implementation, refer to the *Programming Model* chapter of the *Nios II Processor Reference Handbook*.

You can optionally include the MPU when you instantiate the Nios II processor in your Nios II hardware system. When present, the MPU is always enabled. Several parameters are available, allowing you to optimize the MPU for your system needs.

 For complete details of user-selectable parameters for the Nios II MPU, refer to the *Instantiating the Nios II Processor in SOPC Builder* chapter of the *Nios II Processor Reference Handbook*.

 The Nios II MPU is optional and mutually exclusive from the Nios II MMU. Nios II systems can include either an MPU or MMU, but cannot include both an MPU and MMU in the same design.

JTAG Debug Module

The Nios II architecture supports a JTAG debug module that provides on-chip emulation features to control the processor remotely from a host PC. PC-based software debugging tools communicate with the JTAG debug module and provide facilities, such as the following features:

- Downloading programs to memory
- Starting and stopping execution
- Setting breakpoints and watchpoints
- Analyzing registers and memory
- Collecting real-time execution trace data

 The Nios II MMU does not support the JTAG debug module trace.

The debug module connects to the JTAG circuitry in an Altera® FPGA. External debugging probes can then access the processor via the standard JTAG interface on the FPGA. On the processor side, the debug module connects to signals inside the processor core. The debug module has non-maskable control over the processor, and does not require a software stub linked into the application under test. All system resources visible to the processor in supervisor mode are available to the debug module. For trace data collection, the debug module stores trace data in memory either on-chip or in the debug probe.

The debug module gains control of the processor either by asserting a hardware break signal, or by writing a break instruction into program memory to be executed. In both cases, the processor transfers execution to the routine located at the break address. The break address is specified in SOPC Builder at system generation time.

Soft-core processors such as the Nios II processor offer unique debug capabilities beyond the features of traditional, fixed processors. The soft-core nature of the Nios II processor allows you to debug a system in development using a full-featured debug core, and later remove the debug features to conserve logic resources. For the release version of a product, the JTAG debug module functionality can be reduced, or removed altogether.

The following sections describe the capabilities of the Nios II JTAG debug module hardware. The usage of all hardware features is dependent on host software, such as the Nios II IDE, which manages the connection to the target processor and controls the debug process.

JTAG Target Connection

The JTAG target connection provides the ability to connect to the processor through the standard JTAG pins on the Altera FPGA. This provides basic capabilities to start and stop the processor, and examine and edit registers and memory. The JTAG target connection is the minimum requirement for the Nios II IDE flash programmer.



While the processor has no minimum clock frequency requirements, Altera recommends that your design's system clock frequency be at least four times the JTAG clock frequency to ensure that the on-chip instrumentation (OCI) core functions properly.

Download and Execute Software

Downloading software refers to the ability to download executable code and data to the processor's memory via the JTAG connection. After downloading software to memory, the JTAG debug module can then exit debug mode and transfer execution to the start of executable code.

Software Breakpoints

Software breakpoints allow you to set a breakpoint on instructions residing in RAM. The software breakpoint mechanism writes a break instruction into executable code stored in RAM. When the processor executes the break instruction, control is transferred to the JTAG debug module.

Hardware Breakpoints

Hardware breakpoints allow you to set a breakpoint on instructions residing in nonvolatile memory, such as flash memory. The hardware breakpoint mechanism continuously monitors the processor's current instruction address. If the instruction address matches the hardware breakpoint address, the JTAG debug module takes control of the processor.

Hardware breakpoints are implemented using the JTAG debug module's hardware trigger feature.

Hardware Triggers

Hardware triggers activate a debug action based on conditions on the instruction or data bus during real-time program execution. Triggers can do more than halt processor execution. For example, a trigger can be used to enable trace data collection during real-time processor execution.

Table 2-5 lists all the conditions that can cause a trigger. Hardware trigger conditions are based on either the instruction or data bus. Trigger conditions on the same bus can be logically ANDed, enabling the JTAG debug module to trigger, for example, only on write cycles to a specific address.

Table 2-5. Trigger Conditions

Condition	Bus	Description
Specific address	Data, Instruction	Trigger when the bus accesses a specific address.
Specific data value	Data	Trigger when a specific data value appears on the bus.
Read cycle	Data	Trigger on a read bus cycle.
Write cycle	Data	Trigger on a write bus cycle.
Armed	Data, Instruction	Trigger only after an armed trigger event. Refer to “Armed Triggers” on page 2-18.
Range	Data	Trigger on a range of address values, data values, or both. Refer to “Triggering on Ranges of Values” on page 2-18.

When a trigger condition occurs during processor execution, the JTAG debug module triggers an action, such as halting execution, or starting trace capture. Table 2-6 lists the trigger actions supported by the Nios II JTAG debug module.

Table 2-6. Trigger Actions

Action	Description
Break	Halt execution and transfer control to the JTAG debug module.
External trigger	Assert a trigger signal output. This trigger output can be used, for example, to trigger an external logic analyzer.
Trace on	Turn on trace collection.
Trace off	Turn off trace collection.
Trace sample (1)	Store one sample of the bus to trace buffer.
Arm	Enable an armed trigger.

Notes to Table 2-6:

(1) Only conditions on the data bus can trigger this action.

Armed Triggers

The JTAG debug module provides a two-level trigger capability, called armed triggers. Armed triggers enable the JTAG debug module to trigger on event B, only after event A. In this example, event A causes a trigger action that enables the trigger for event B.

Triggering on Ranges of Values

The JTAG debug module can trigger on ranges of data or address values on the data bus. This mechanism uses two hardware triggers together to create a trigger condition that activates on a range of values within a specified range.

Trace Capture

Trace capture refers to ability to record the instruction-by-instruction execution of the processor as it executes code in real-time. The JTAG debug module offers the following trace features:

- Capture execution trace (instruction bus cycles).
- Capture data trace (data bus cycles).

- For each data bus cycle, capture address, data, or both.
- Start and stop capturing trace in real time, based on triggers.
- Manually start and stop trace under host control.
- Optionally stop capturing trace when trace buffer is full, leaving the processor executing.
- Store trace data in on-chip memory buffer in the JTAG debug module. (This memory is accessible only through the JTAG connection.)
- Store trace data to larger buffers in an off-chip debug probe.

Certain trace features require additional licensing or debug tools from third-party debug providers. For example, an on-chip trace buffer is a standard feature of the Nios II processor, but using an off-chip trace buffer requires additional debug software and hardware provided by First Silicon Solutions (FS2) or Lauterbach GmbH.



For details, refer to the FS2 website (www.fs2.com) and the Lauterbach GmbH website (www.lauterbach.com).

Execution vs. Data Trace

The JTAG debug module supports tracing the instruction bus (execution trace), the data bus (data trace), or both simultaneously. Execution trace records only the addresses of the instructions executed, enabling you to analyze where in memory (i.e., in which functions) code executed. Data trace records the data associated with each load and store operation on the data bus.

The JTAG debug module can filter the data bus trace in real time to capture the following:

- Load addresses only
- Store addresses only
- Both load and store addresses
- Load data only
- Load address and data
- Store address and data
- Address and data for both loads and stores
- Single sample of the data bus upon trigger event

Trace Frames

A frame is a unit of memory allocated for collecting trace data. However, a frame is not an absolute measure of the trace depth.

To keep pace with the processor executing in real time, execution trace is optimized to store only selected addresses, such as branches, calls, traps, and interrupts. From these addresses, host-side debug software can later reconstruct an exact instruction-by-instruction execution trace. Furthermore, execution trace data is stored in a compressed format, such that one frame represents more than one instruction. As a result of these optimizations, the actual start and stop points for trace collection during execution might vary slightly from the user-specified start and stop points.

Data trace stores 100% of requested loads and stores to the trace buffer in real time. When storing to the trace buffer, data trace frames have lower priority than execution trace frames. Therefore, while data frames are always stored in chronological order, execution and data trace are not guaranteed to be exactly synchronized with each other.

Referenced Documents

This chapter references the following documents:

- *Programming Model* chapter of the *Nios II Processor Reference Handbook*
- *Instantiating the Nios II Processor in SOPC Builder* chapter of the *Nios II Processor Reference Handbook*
- *Nios II Core Implementation Details* chapter of the *Nios II Processor Reference Handbook*
- *Instruction Set Reference* chapter of the *Nios II Processor Reference Handbook*
- *Developing Programs Using the Hardware Abstraction Layer* chapter of the *Nios II Software Developer's Handbook*
- *Nios II Custom Instruction User Guide*
- *Avalon Interface Specifications*
- *AN 391: Profiling Nios II Systems*
- [Literature: Megafunctions](#) page on the Altera website

Document Revision History

Table 2-7 shows the revision history for this document.

Table 2-7. Document Revision History (Part 1 of 2)

Date & Document Version	Changes Made	Summary of Changes
March 2009 v9.0.0	Maintenance release.	—
November 2008 v8.1.0	<ul style="list-style-type: none"> ■ Expanded floating-point instructions information. ■ Updated description of optional <code>cpu_resetrequest</code> and <code>cpu_resettaken</code> signals. ■ Added description of optional <code>debugreq</code> and <code>debugack</code> signals. 	—
May 2008 v8.0.0	Added MMU and MPU sections.	Added MMU and MPU.

Table 2-7. Document Revision History (Part 2 of 2)

Date & Document Version	Changes Made	Summary of Changes
October 2007 v7.2.0	Maintenance release.	—
May 2007 v7.1.0	<ul style="list-style-type: none"> ■ Added table of contents to Introduction section. ■ Added Referenced Documents section. 	—
March 2007 v7.0.0	Maintenance release.	—
November 2006 v6.1.0	Described interrupt vector custom instruction.	Interrupt vector custom instruction added.
May 2006 v6.0.0	<ul style="list-style-type: none"> ■ Added description of optional <code>cpu_resetrequest</code> and <code>cpu_resettaken</code>. ■ Added section on single precision floating-point instructions. 	—
October 2005 v5.1.0	Maintenance release.	—
May 2005 v5.0.0	Added tightly-coupled memory.	—
December 2004 v1.2	Added new control register <code>ctl5</code> .	—
September 2004 v1.1	Updates for Nios II 1.01 release.	—
May 2004 v1.0	Initial release.	—

Introduction

This chapter describes the Nios® II programming model, covering processor features at the assembly language level. Fully understanding the contents of this chapter requires prior knowledge of computer architecture, operating systems, virtual memory and memory management, software processes and process management, exception handling, and instruction sets. This chapter assumes you have a detailed understanding of the aforementioned concepts and focuses on how these concepts are specifically implemented in the Nios II processor. Where possible, this chapter uses industry-standard terminology.

This chapter discusses the following topics from the system programmer's perspective:

- Operating modes, [page 3-2](#)—Defines the relationships between executable code and memory.
- Memory management unit (MMU), [page 3-3](#)—Describes virtual memory support for full-featured operating systems.
- Memory protection unit (MPU), [page 3-8](#)—Describes memory protection without virtual memory management.
- General-purpose registers, [page 3-10](#)—Describes the Nios II general register set.
- Control registers, [page 3-11](#)—Describes the Nios II control register set.
- Exception processing, [page 3-25](#)—Describes how the Nios II processor responds to exceptions.
- Processor reset state, [page 3-27](#)—Describes how the Nios II processor responds to a processor reset signal.
- Hardware-assisted debug processing, [page 3-28](#)—Describes how the Nios II processor responds to break exceptions.
- Hardware interrupts, [page 3-29](#)—Describes how the Nios II processor responds to hardware interrupts.
- Memory, cache memory, and peripheral organization, [page 3-38](#)—Describes how the Nios II processor interfaces with memory and peripherals.
- Instruction set categories, [page 3-40](#)—Introduces the Nios II instruction set.
- Custom instructions, [page 3-44](#)—Describes the scope of Nios II custom instructions.



Because of the flexibility and capability range of the Nios II processor, this chapter covers topics that support a variety of operating systems and runtime environments. While reading, be aware that all sections might not apply to you. For example, if you are using a minimal system runtime environment, you can skip the sections covering operating modes, the MMU, the MPU, or the control registers exclusively used by the MMU and MPU.

 High-level software development tools are not discussed here. Refer to the *Nios II Software Developer's Handbook* for information about developing software.

Operating Modes

Operating modes control how the processor operates, manages system memory, and accesses peripherals. The Nios II architecture supports these operating modes:

- Supervisor mode
- User mode

The following sections define the modes, their relationship to your system software and application code, and their relationship to the Nios II MMU and Nios II MPU. Refer to “[Memory Management Unit](#)” on page 3-3 for more information about the Nios II MMU. Refer to “[Memory Protection Unit](#)” on page 3-8 for more information about the Nios II MPU.

Supervisor Mode

Supervisor mode allows unrestricted operation of the processor. All code has access to all processor instructions and resources. The processor may perform any operation the Nios II architecture provides. Any instruction may be executed, any I/O operation may be initiated, and any area of memory may be accessed.

Operating systems and other system software run in supervisor mode. In systems with an MMU, application code runs in user mode, and the operating system, running in supervisor mode, controls the application's access to memory and peripherals. In systems with an MPU, your system software controls the mode in which your application code runs. In Nios II systems without an MMU or MPU, all application and system code runs in supervisor mode.

Code that needs direct access to and control of the processor runs in supervisor mode. For example, the processor enters supervisor mode whenever a processor exception (including processor reset or break) occurs. Software debugging tools also use supervisor mode to implement features such as breakpoints and watchpoints.



For systems without an MMU or MPU, all code runs in supervisor mode.

User Mode

User mode is available only when the Nios II processor in your hardware design includes an MMU or MPU. User mode exists solely to support operating systems. Operating systems (that make use of the processor's user mode) run your application code in user mode. The user mode capabilities of the processor are a subset of the supervisor mode capabilities. Only a subset of the instruction set is available in user mode.

The operating system determines which memory addresses are accessible to user mode applications. Attempts by user mode applications to access memory locations without user access enabled are not permitted and cause an exception. Code running in user mode uses system calls to make requests to the operating system to perform I/O operations, manage memory, and access other system functionality in the supervisor memory.

The Nios II MMU statically divides the 32-bit virtual address space into user and supervisor partitions. Refer to [“Address Space and Memory Partitions” on page 3-4](#) for more information about the MMU memory partitions. The MMU provides operating systems access permissions on a per-page basis. Refer to [“Virtual Addressing” on page 3-3](#) for more information about MMU pages.

The Nios II MPU supervisor and user memory divisions are determined by the operating system or runtime environment. The MPU provides user access permissions on a region basis. Refer to [“Memory Regions” on page 3-8](#) for more information about MPU regions.

Memory Management Unit

The Nios II processor provides an MMU to support full-featured operating systems. Operating systems that require virtual memory rely on an MMU to manage the virtual memory. When present, the MMU manages memory accesses including translation of virtual addresses to physical addresses, memory protection, cache control, and software process memory allocation.

Recommended Usage

Including the Nios II MMU in your Nios II hardware system is optional. The MMU is only useful with an operating system that takes advantage of it.

Many Nios II systems have simpler requirements where minimal system software or a small-footprint operating system (such as Altera® HAL or a third party real-time operating system) is sufficient. Such software is unlikely to function correctly in a hardware system with an MMU-based Nios II processor. Do not include an MMU in your Nios II system unless your operating system requires it.



The Altera HAL and HAL-based real-time operating systems do not support the MMU.

If your system needs memory protection, but not virtual memory management, refer to [“Memory Protection Unit” on page 3-8](#).

Memory Management

Memory management comprises two key functions:

- Virtual addressing—Mapping a virtual memory space into a physical memory space
- Memory protection—Allowing access only to certain memory under certain conditions

Virtual Addressing

A virtual address is the address that software uses. A physical address is the address which the hardware outputs on the address lines of the Avalon® bus. The Nios II MMU divides virtual memory into 4 KByte pages and physical memory into 4 KByte frames.

The MMU contains a hardware translation lookaside buffer (TLB). The operating system is responsible for creating and maintaining a page table (or equivalent data structures) in memory. The hardware TLB acts as a software managed cache for the page table. The MMU does not perform any operations on the page table, such as hardware table walks. Therefore the operating system is free to implement its page table in any appropriate manner.

Table 3-1 shows how the Nios II MMU divides up the virtual address. There is a 20 bit virtual page number (VPN) and a 12 bit page offset.

Table 3-1. MMU Virtual Address Fields

31	30	29	28	27	26	25	24	23	22	21	20	19	18	17	16	15	14	13	12	11	10	9	8	7	6	5	4	3	2	1	0
Virtual Page Number																				Page Offset											

As input, the TLB takes a VPN plus a process identifier (to guarantee uniqueness). As output, the TLB provides the corresponding physical frame number (PFN).

Distinct processes can use the same virtual address space. The process identifier, concatenated with the virtual address, distinguishes identical virtual addresses in separate processes. To determine the physical address, the Nios II MMU translates a VPN to a PFN and then concatenates the PFN with the page offset. The bits in the page offset are not translated.

Memory Protection

The Nios II MMU maintains read, write, and execute permissions for each page. The TLB provides the permission information when translating a VPN. The operating system can control whether or not each process is allowed to read data from, write data to, or execute instructions on each particular page. The MMU also controls whether accesses to each data page are cacheable or uncacheable by default.

Whenever an instruction attempts to access a page that either has no TLB mapping, or lacks the appropriate permissions, the MMU generates a precise exception. Precise exceptions enable the system software to update the TLB, and then re-execute the instruction if desired.

Address Space and Memory Partitions

The MMU provides a 4 GByte virtual address space, and is capable of addressing up to 4 GBytes of physical memory.



The amount of actual physical memory, determined by the configuration of your hardware system, might be less than the available 4 GBytes of physical address space.

Virtual Memory Address Space

The 4 GByte virtual memory space is divided into partitions. The upper 2 GBytes of memory is reserved for the operating system and the lower 2 GBytes is reserved for user processes. Table 3-2 names and describes the partitions.

Table 3-2. Virtual Memory Partitions

Partition	Virtual Address Range	Used By	Memory Access	User Mode Access	Default Data Cacheability
I/O (1)	0xE0000000-0xFFFFFFFF	Operating system	Bypasses TLB	No	Disabled
Kernel (1)	0xC0000000-0xDFFFFFFF	Operating system	Bypasses TLB	No	Enabled
Kernel MMU (1)	0x80000000-0xBFFFFFFF	Operating system	Uses TLB	No	Set by TLB
User	0x00000000-0x7FFFFFFF	User processes	Uses TLB	Set by TLB	Set by TLB

Note to Table 3-2:

(1) Supervisor-only partition

Each partition has a specific size, purpose, and relationship to the TLB:

- The 512 MByte I/O partition provides access to peripherals.
- The 512 MByte kernel partition provides space for the operating system kernel.
- The 1 GByte kernel MMU partition is used by the TLB miss handler and kernel processes.
- The 2 GByte user partition is used by application processes.

I/O and kernel partitions bypass the TLB. The kernel MMU and user partitions use the TLB. If all software runs in the kernel partition, the MMU is effectively disabled.

Physical Memory Address Space

The 4 GByte physical memory is divided into low memory and high memory. The lowest 0.5 GBytes of physical address space is low memory. The upper 3.5 GBytes of physical address space is high memory. Figure 3-1 shows how physical memory is divided.

Figure 3-1. Division of Physical Memory

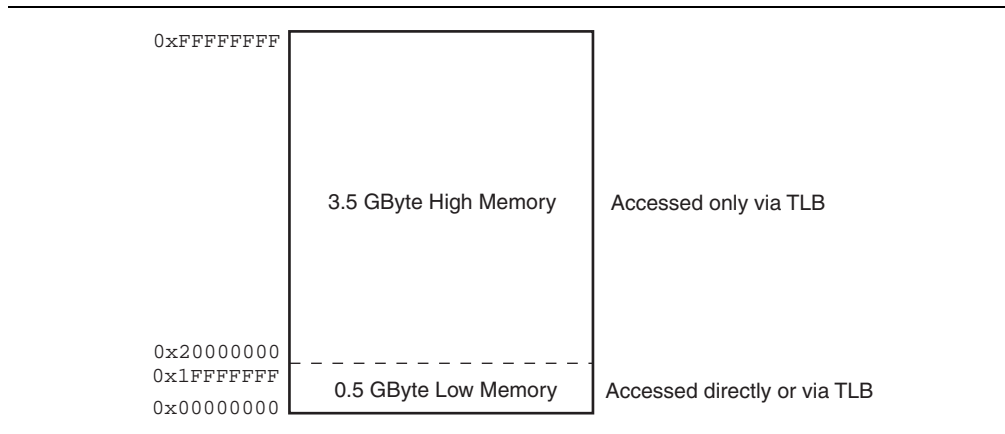

High physical memory can only be accessed through the TLB. Any physical address in low memory (29-bits or less) can be accessed through the TLB or by bypassing the TLB. When bypassing the TLB, a 29-bit physical address is computed by clearing the top three bits of the 32-bit virtual address.



To function correctly, the base physical address of all exception vectors (reset, general exception, break, and fast TLB miss) must point to low physical memory so that hardware can correctly map their virtual addresses into the kernel partition. This restriction is enforced by the Nios II Processor MegaWizard interface in SOPC Builder.

Data Cacheability

Each partition has a rule that determines the default data cacheability property of each memory access. When data cacheability is enabled on a partition of the address space, a data access to that partition can be cached, if a data cache is present in the system. When data cacheability is disabled, all access to that partition goes directly to the Avalon switch fabric. Bit 31 is not used to specify data cacheability, as it is in Nios II cores without MMUs. Virtual memory partitions that bypass the TLB have a default data cacheability property, as shown in [Table 3-2](#). For partitions that are mapped through the TLB, data cacheability is controlled by the TLB on a per-page basis.

Non-I/O load and store instructions use the default data cacheability property. I/O load and store instructions are always non-cacheable, so they ignore the default data cacheability property.

TLB Organization

A TLB functions as a cache for the operating system's page table. In Nios II processors with an MMU, one main TLB is shared by instruction and data accesses. The TLB is stored in on-chip RAM and handles translations for instruction fetches and instructions that perform data accesses.

The TLB is organized as an n -way set-associative cache. The software specifies the way (set) when loading a new entry.



You can configure the number of TLB entries and the number of ways (set associativity) of the TLB in SOPC Builder at system generation time. By default, the TLB is a 16-way cache. The default number of entries depends on the target device, as follows:

- Cyclone®, Cyclone II, Stratix®, Stratix II, Stratix II GX—128 entries, requiring one M4K RAM
- Cyclone III, Stratix III, Stratix IV—256 entries, requiring one M9K RAM

For further detail, refer to the *Instantiating the Nios II Processor in SOPC Builder* chapter of the *Nios II Processor Reference Handbook*.

The operating system software is responsible for guaranteeing that multiple TLB entries do not map the same virtual address. The hardware behavior is undefined when multiple entries map the same virtual address.

Each TLB entry consists of a tag and data portion. This is analogous to the tag and data portion of instruction and data caches.

 Refer to the *Nios II Core Implementation Details* chapter of the *Nios II Processor Reference Handbook* for details on instruction and data caches.

The tag portion of a TLB entry contains information used when matching a virtual address to a TLB entry. [Table 3-3](#) describes the tag portion of a TLB entry.

Table 3-3. TLB Tag Portion Contents

Field Name	Description
VPN	VPN is the virtual page number field. This field is compared with the top 20 bits of the virtual address.
PID	PID is the process identifier field. This field is compared with the value of the current process identifier stored in the <code>tlbmisc</code> control register, effectively extending the virtual address. The field size is configurable at system generation time, and can be between 8 and 14 bits.
G	G is the global flag. When <code>G = 1</code> , the PID is ignored in the TLB lookup.

The TLB data portion determines how to translate a matching virtual address to a physical address. [Table 3-4](#) describes the data portion of a TLB entry.

Table 3-4. TLB Data Portion Contents

Field Name	Description
PFN	PFN is the physical frame number field. This field specifies the upper bits of the physical address. The size of this field depends on the range of physical addresses present in the system. The maximum size is 20 bits.
C	C is the cacheable flag. Determines the default data cacheability of a page. Can be overridden for data accesses using I/O load and store family of Nios II instructions.
R	R is the readable flag. Allows load instructions to read a page.
W	W is the writeable flag. Allows store instructions to write a page.
X	X is the executable flag. Allows instruction fetches from a page.

 Because there is no “valid bit” in the TLB entry, the operating system software invalidates the TLB by writing unique VPN values from the I/O partition of virtual addresses into each TLB entry.

TLB Lookups

A TLB lookup attempts to convert a virtual address (VADDR) to a physical address (PADDR).

The TLB lookup algorithm for instruction fetches is as follows:

```

if (VPN match and (G = 1 or PID match))
    if (X = 1)
        PADDR = concat(PFN, VADDR[11:0])
    else
        take TLB permission violation exception
else
    if (EH bit of status register = 1)
        take double TLB miss exception
    else
        take fast TLB miss exception
    
```

Refer to [“Instruction-Related Exceptions”](#) on page 3-30 for details on TLB exceptions.

The TLB lookup algorithm for data accesses is as follows:

```
if (VPN match and (G = 1 or PID match))
    if ((load and R = 1) or (store and W = 1) or flushda)
        PADDR = concatenate(PFN, VADDR[11:0])
    else
        take TLB permission violation exception
else
    if (EH bit of status register = 1)
        take double TLB miss exception
    else
        take fast TLB miss exception
```

Memory Protection Unit

The Nios II processor provides an MPU for operating systems and runtime environments that desire memory protection but do not require virtual memory management. For information about memory protection with virtual memory management, refer to [“Memory Management Unit” on page 3-3](#).

When present and enabled, the MPU monitors all Nios II instruction fetches and data memory accesses to protect against errant software execution. The MPU is a hardware facility that system software uses to define memory regions and their associated access permissions. The MPU triggers a precise exception if software attempts to access a memory region in violation of its permissions, allowing you to intervene and handle the exception as appropriate. The precise exception effectively prevents the illegal access to memory.

The MPU extends the Nios II processor to support user mode and supervisor mode. Typically, system software runs in supervisor mode and end-user applications run in user mode, although all software can run in supervisor mode if desired. System software defines which MPU regions belong to supervisor mode and which belong to user mode.

Memory Regions

The MPU contains up to 32 instruction regions and 32 data regions. Each region is defined by the following attributes:

- Base address
- Region type
- Region index
- Region size or upper address limit
- Access permissions
- Default cacheability (data regions only)

Base Address

The base address specifies the lowest address of the region. The base address is aligned on a region-sized boundary. For example, a 4 Kbyte region must have a base address that is a multiple of 4 Kbytes. If the base address is not properly aligned, the behavior is undefined.

Region Type

Each region is identified as either an instruction region or a data region.

Region Index

Each region has an index ranging from zero to the number of regions of its region type minus one. Index zero has the highest priority.

Region Size or Upper Address Limit

An SOPC Builder generation-time option controls whether the amount of memory in the region is defined by size or upper address limit. The size is an integer power of two bytes. The limit is the highest address of the region plus one. The minimum supported region size is 64 bytes but can be configured at system generation time for larger minimum sizes to save logic resources. The maximum supported region size equals the Nios II address space (a function of the address ranges of slaves connected to the Nios II masters). Any access outside of the Nios II address space is considered not to match any region and triggers an MPU region violation exception.

When regions are defined by size, the size is encoded as a binary mask to facilitate the following MPU region address range matching:

```
(address & region_mask) == region_base_address
```

When regions are defined by limit, the limit is encoded as an unsigned integer to facilitate the following MPU region address range matching:

```
(address >= region_base) && (address < region_limit)
```

The region limit uses a less-than instead of a less-than-or-equal-to comparison because less-than provides a more efficient implementation. The limit is one bit larger than the address so that full address range may be included in a range. Defining the region by limit results in slower and larger address range match logic than defining by size but allows finer granularity in region sizes.

Access Permissions

The access permissions consist of execute permissions for instruction regions and read/write permissions for data regions. Any instruction that performs a memory access that violates the access permissions triggers an exception. Additionally, any instruction that performs a memory access that does not match any region triggers an exception.

Default Cacheability

The default cacheability specifies whether normal load and store instructions access the data cache or bypass the data cache. The default cacheability is only present for data regions. You can override the default cacheability by using the `ldio` or `stio` instructions. The bit 31 cache bypass feature is available when the MPU is present. Refer to [“Cache Memory” on page 3-38](#) for more information on cache bypass.

Overlapping Regions

The memory addresses of regions can overlap. Overlapping regions have several uses including placing markers or small holes inside of a larger region. For example, the stack and heap may be located in the same region. To detect stack/heap overflows, you can define a small region between the stack and heap with no access permissions and assign it a higher priority than the larger region. Any access attempts to the hole region trigger an exception informing system software about the stack/heap overflow.

If regions overlap so that a particular access matches more than one region, the region with the highest priority (lowest index) determines the access permissions and default cacheability.

Enabling the MPU

The MPU is disabled on system reset. System software enables and disables the MPU by writing to a control register. Before enabling the MPU, you must create at least one instruction and one data region, otherwise unexpected results can occur. Refer to “Working with the MPU” on page 3-24 for more information.

General-Purpose Registers

The Nios II architecture provides thirty-two 32-bit general-purpose registers, r0 through r31, as shown in Table 3-5. Some registers have names recognized by the assembler. For example, the zero register (r0) always returns the value zero, and writing to zero has no effect. The ra register (r31) holds the return address used by procedure calls and is implicitly accessed by call and ret instructions. C and C++ compilers use a common procedure-call convention, assigning specific meaning to registers r1 through r23 and r26 through r28.

Table 3-5. The Nios II General Purpose Registers (Part 1 of 2)

Register	Name	Function	Register	Name	Function
r0	zero	0x00000000	r16		
r1	at	Assembler temporary	r17		
r2		Return value	r18		
r3		Return value	r19		
r4		Register arguments	r20		
r5		Register arguments	r21		
r6		Register arguments	r22		
r7		Register arguments	r23		
r8		Caller-saved register	r24	et	Exception temporary
r9		Caller-saved register	r25	bt	Breakpoint temporary (1)
r10		Caller-saved register	r26	gp	Global pointer
r11		Caller-saved register	r27	sp	Stack pointer
r12		Caller-saved register	r28	fp	Frame pointer
r13		Caller-saved register	r29	ea	Exception return address
r14		Caller-saved register	r30	ba	Breakpoint return address (1)

Table 3-5. The Nios II General Purpose Registers (Part 2 of 2)

Register	Name	Function	Register	Name	Function
r15		Caller-saved register	r31	ra	Return address

Notes to Table 3-5:

(1) This register is used exclusively by the JTAG debug module.



For more information, refer to the *Application Binary Interface* chapter of the *Nios II Processor Reference Handbook*.

Control Registers

Control registers report the status and change the behavior of the processor. Control registers are accessed differently than the general-purpose registers. The special instructions `rdctl` and `wrctl` provide the only means to read and write to the control registers and are only available in supervisor mode.



When writing to control registers, all undefined bits must be written as zero.

The Nios II architecture supports up to 32 control registers. Table 3-6 shows details of the currently-defined control registers. All non-reserved control registers have names recognized by the assembler.

Table 3-6. Control Register Names and Bits

Register	Name	Register Contents
0	<code>status</code>	Refer to Table 3-7 on page 3-12
1	<code>estatus</code>	Refer to Table 3-9 on page 3-12
2	<code>bstatus</code>	Refer to Table 3-10 on page 3-13
3	<code>ienable</code>	Interrupt-enable bits
4	<code>ipending</code>	Pending-interrupt bits
5	<code>cpuid</code>	Unique processor identifier
6	Reserved	Reserved
7	<code>exception</code>	Refer to Table 3-11 on page 3-14
8	<code>pteaddr (1)</code>	Refer to Table 3-13 on page 3-14
9	<code>tlbacc (1)</code>	Refer to Table 3-15 on page 3-15
10	<code>tlbmisc (1)</code>	Refer to Table 3-17 on page 3-16
11	Reserved	Reserved
12	<code>badaddr</code>	Refer to Table 3-19 on page 3-19
13	<code>config (2)</code>	Refer to Table 3-21 on page 3-19
14	<code>mpubase (2)</code>	Refer to Table 3-23 on page 3-20
15	<code>mpuacc (2)</code>	Refer to Table 3-25 on page 3-21
16-31	Reserved	Reserved

Notes to Table 3-6:

(1) Available only when the MMU is present. Otherwise reserved.

(2) Available only when the MPU is present. Otherwise reserved.

The following sections describe the non-reserved control registers.

The status Register

The value in the `status` register controls the state of the Nios II processor. All status bits are cleared at processor reset. Some bits are exclusively used by and available only to certain features of the processor. Table 3-7 shows the layout of the `status` register.

Table 3-7. status Control Register Fields

31	30	29	28	27	26	25	24	23	22	21	20	19	18	17	16	15	14	13	12	11	10	9	8	7	6	5	4	3	2	1	0
Reserved																											EH	U	PIE		

Table 3-8 gives details of the fields defined in the `status` register.

Table 3-8. status Control Register Field Descriptions

Bit	Description	Access	Reset	Available
EH (1)	EH is the exception handler bit. The processor sets EH to one when an exception occurs (including breaks). Software clears EH to zero when ready to handle exceptions again. EH is used by the MMU to determine whether a TLB miss exception is a fast TLB miss or a double TLB miss. In systems without an MMU, EH is always zero.	Read/Write	0	MMU only
U (1)	U is the user mode bit. When U = 1, the processor operates in user mode. When U = 0, the processor operates in supervisor mode. In systems without an MMU, U is always zero.	Read/Write	0	MMU or MPU only
PIE	PIE is the processor interrupt-enable bit. When PIE = 0, interrupts are ignored. When PIE = 1, interrupts can be taken, depending on the value of the <code>ienable</code> register.	Read/Write	0	Always

Notes to Table 3-8:

- (1) The state where both EH and U are one is illegal and causes undefined results.

The estatus Register

The `estatus` register holds a saved copy of the `status` register during non-break exception processing. Table 3-9 shows the layout of the `status` register.

Table 3-9. estatus Control Register Fields

31	30	29	28	27	26	25	24	23	22	21	20	19	18	17	16	15	14	13	12	11	10	9	8	7	6	5	4	3	2	1	0
Reserved																											EEH	EU	EPIE		

The names of the defined bits are the same as the `status` register bits prepended with the letter E. Table 3-8 also describes the details of the fields defined in the `estatus` register.

The exception handler can examine `estatus` to determine the pre-exception status of the processor. When returning from an exception, the `eret` instruction causes the processor to copy `estatus` back to `status`, restoring the pre-exception value of `status`. Refer to “Exception Processing” on page 3-25 for more information.

The bstatus Register

The `bstatus` register holds a saved copy of the status register during break exception processing. Table 3-10 shows the layout of the status register.

Table 3-10. bstatus Control Register Fields

31	30	29	28	27	26	25	24	23	22	21	20	19	18	17	16	15	14	13	12	11	10	9	8	7	6	5	4	3	2	1	0
Reserved																											BEH	BU	BPIE		

The names of the defined bits are the same as the status register bits prepended with the letter B. Table 3-8 also describes the details of the fields defined in the `estatus` register.

When a break occurs, the value of the status register is copied into `bstatus`. Using `bstatus`, the debugger can restore the status register to the value prior to the break. The `bret` instruction causes the processor to copy `bstatus` back to status. Refer to “Processing a Break” on page 3-28 for more information.

The ienable Register

The `ienable` register controls the handling of external hardware interrupts. Each bit of the `ienable` register corresponds to one of the interrupt inputs, `irq0` through `irq31`. A value of one in bit n means that the corresponding `irqn` interrupt is enabled; a bit value of zero means that the corresponding interrupt is disabled. Refer to “Exception Processing” on page 3-25 for more information.

The ipending Register

The value of the `ipending` register indicates the value of the interrupt signals driven into the processor. A value of one in bit n means that the corresponding `irqn` input is asserted. Writing a value to the `ipending` register has no effect.

The cpuid Register

The `cpuid` register holds a constant value that uniquely identifies each processor in a multi-processor system. The `cpuid` value is determined at system generation time and is guaranteed to be unique for each processor in the system. Writing to the `cpuid` register has no effect.

The exception Register

When the extra exception information option is enabled, the Nios II processor provides information useful to system software for exception processing in the `exception` and `badaddr` registers when an exception occurs. When your system contains an MMU or MPU, the extra exception information is always enabled. When no MMU or MPU is present, the Nios II Megawizard interface gives you the option to have the processor provide the extra exception information.

To see how to control the extra exception information option, refer to the *Instantiating the Nios II Processor in SOPC Builder* chapter of the *Nios II Processor Reference Handbook*. Table 3-11 shows the layout of the `exception` register.

Table 3-11. exception Control Register Field Descriptions

Field	Description	Access	Reset	Available
CAUSE	CAUSE is written by the Nios II processor when any non-break exception occurs. CAUSE contains a code for the highest-priority exception occurring at the time. The Cause column in Table 3-31 on page 3-26 shows the CAUSE field value for each exception.	Read	0	Only with extra exception information

[Table 3-12](#) gives details of the fields defined in the exception register.

Table 3-12. exception Control Register Fields

31	30	29	28	27	26	25	24	23	22	21	20	19	18	17	16	15	14	13	12	11	10	9	8	7	6	5	4	3	2	1	0
Reserved																								CAUSE			Rsvd				

The pteaddr Register

The `pteaddr` register contains the virtual address of the operating system's page table and is only available in systems with an MMU. The `pteaddr` register layout accelerates fast TLB miss exception handling. [Table 3-13](#) shows the layout of the `pteaddr` register.

Table 3-13. pteaddr Control Register Fields

31	30	29	28	27	26	25	24	23	22	21	20	19	18	17	16	15	14	13	12	11	10	9	8	7	6	5	4	3	2	1	0
PTBASE											VPN																Rsvd				

[Table 3-14](#) gives details of the fields defined in the `pteaddr` register.

Table 3-14. pteaddr Control Register Field Descriptions

Field	Description	Access	Reset	Available
PTBASE	PTBASE is the base virtual address of the page table.	Read/Write	0	Only with MMU
VPN	VPN is the virtual page number. VPN can be set by both hardware and software.	Read/Write	0	Only with MMU

Software writes to the PTBASE field when switching processes. Hardware never writes to the PTBASE field.

Software writes to the VPN field when writing a TLB entry. Hardware writes to the VPN field on a fast TLB miss exception, a TLB permission violation exception, or on a TLB read operation. The VPN field is not written on any exceptions taken when an exception is already active, that is, when `status.EH` is already one.

The tlbacc Register

The `tlbacc` register is used to access TLB entries and is only available in systems with an MMU. The `tlbacc` register holds values that software will write into a TLB entry or has previously read from a TLB entry. The `tlbacc` register provides access to only a portion of a complete TLB entry. `pteaddr.VPN` and `tlbmisc.PID` hold the remaining TLB entry fields.

[Table 3-15](#) shows the layout of the `tlbacc` register.

Table 3-15. tlbacc Control Register Fields

31	30	29	28	27	26	25	24	23	22	21	20	19	18	17	16	15	14	13	12	11	10	9	8	7	6	5	4	3	2	1	0
IG								C	R	W	X	G	PFN																		

Table 3-16 gives details of the fields defined in the tlbacc register.

Table 3-16. tlbacc Control Register Field Descriptions

Field	Description	Access	Reset	Available
IG	IG is ignored by hardware and available to hold operating system specific information. Read as zero but can be written as non-zero.	Read/Write	0	Only with MMU
C	C is the data cacheable flag. When C = 0, data accesses are uncacheable. When C = 1, data accesses are cacheable.	Read/Write	0	Only with MMU
R	R is the readable flag. When R = 0, load instructions are not allowed to access memory. When R = 1, load instructions are allowed to access memory.	Read/Write	0	Only with MMU
W	W is the writable flag. When W = 0, store instructions are not allowed to access memory. When W = 1, store instructions are allowed to access memory.	Read/Write	0	Only with MMU
X	X is the executable flag. When X = 0, instructions are not allowed to execute. When X = 1, instructions are allowed to execute.	Read/Write	0	Only with MMU
G	G is the global flag. When G = 0, tlbmisc.PID is included in the TLB lookup. When G = 1, tlbmisc.PID is ignored and only the virtual page number is used in the TLB lookup.	Read/Write	0	Only with MMU
PFN	PFN is the physical frame number field. All unused upper bits must be zero.	Read/Write	0	Only with MMU

Issuing a wrctl instruction to the tlbacc register writes the tlbacc register with the specified value. If tlbmisc.WE = 1, the wrctl instruction also initiates a TLB write operation, which writes a TLB entry. The TLB entry written is specified by the line portion of pteaddr.VPN and the tlbmisc.WAY field. The value written is specified by the value written into tlbacc along with the values of pteaddr.VPN and tlbmisc.PID. A TLB write operation also increments tlbmisc.WAY, allowing software to quickly modify TLB entries.

Issuing a rdctl instruction to the tlbacc register returns the value of the tlbacc register. The tlbacc register is written by hardware when software triggers a TLB read operation (that is, when wrctl sets tlbmisc.RD to one).

The tlbacc register format is the recommended format for entries in the operating system page table. The IG bits are ignored by the hardware on wrctl to tlbacc and read back as zero on rdctl from tlbacc. The operating system can use the IG bits to hold operating system specific information without having to clear these bits to zero on a TLB write operation.

The tlbmisc Register

The tlbmisc register contains the remaining TLB-related fields and is only available in systems with an MMU. Table 3-17 shows the layout of the tlbmisc register.

Table 3-17. tlbmisc Control Register Fields

31	30	29	28	27	26	25	24	23	22	21	20	19	18	17	16	15	14	13	12	11	10	9	8	7	6	5	4	3	2	1	0
Reserved											WAY (1)			RD	WE	PID (1)											DBL	BAD	PERM	D	

Notes to Table 3-17:

(1) This field size is variable. Unused upper bits must be written as zero.

Table 3-18 gives details of the fields defined in the `tlbmisc` register.

Table 3-18. tlbmisc Control Register Field Descriptions

Field	Description	Access	Reset	Available
WAY	The WAY field controls the mapping from the VPN to a particular TLB entry.	Read/Write	0	Only with MMU
RD	RD is the read flag. Setting RD to one triggers a TLB read operation.	Write	0	Only with MMU
WE	WE is the TLB write enable flag. When WE = 1, a write to <code>tlbacc</code> writes through to a TLB entry.	Read/Write	0	Only with MMU
PID	PID is the process identifier field.	Read/Write	0	Only with MMU
DBL (1)	DBL is the double TLB miss exception flag.	Read	0	Only with MMU
BAD (1)	BAD is the bad virtual address exception flag.	Read	0	Only with MMU
PERM (1)	PERM is the TLB permission violation exception flag.	Read	0	Only with MMU
D	D is the data access exception flag. When D = 1, the exception is a data access exception. When D = 0, the exception is an instruction access exception.	Read	0	Only with MMU

Notes to Table 3-18:

(1) You can also use `exception.CAUSE` to determine these exceptions.

The sections below provide further details of the `tlbmisc` fields.

The RD Flag

System software triggers a TLB read operation by setting `tlbmisc.RD` (with a `wrc1l` instruction). A TLB read operation loads the following register fields with the contents of a TLB entry:

- The tag portion of `pteaddr.VPN`
- `tlbmisc.PID`
- The `tlbacc` register

The TLB entry to be read is specified by the following values:

- the line portion of `pteaddr.VPN`
- `tlbmisc.WAY`

When system software changes the fields that specify the TLB entry, there is no immediate effect on `ptaddr.VPN`, `tlbmisc.PID`, or the `tlbacc` register. The registers retain their previous values until the next TLB read operation is initiated. For example, when the operating system sets `ptaddr.VPN` to a new value, the contents of `tlbacc` continues to reflect the previous TLB entry. `tlbacc` does not contain the new TLB entry until after an explicit TLB read.

The WE Flag

When `WE = 1`, a write to `tlbacc` writes the `tlbacc` register and a TLB entry. When `WE = 0`, a write to `tlbacc` only writes the `tlbacc` register.

Hardware sets the `WE` flag to one on a TLB permission violation exception, and on a TLB miss exception when `status.EH = 0`. When a TLB write operation writes the `tlbacc` register, the write operation also writes to a TLB entry when `WE = 1`.

The WAY Field

The `WAY` field controls the mapping from the `VPN` to a particular TLB entry. `WAY` specifies the set to be written to in the TLB. The MMU increments `WAY` when system software performs a TLB write operation. Unused upper bits in `WAY` must be written as zero.



The number of ways (sets) is configurable in SOPC Builder at generation time, up to a maximum of 16.

The PID Field

`PID` is a unique identifier for the current process that effectively extends the virtual address. The process identifier can be less than 14 bits. Any unused upper bits must be zero.

`tlbmisc.PID` contains the `PID` field from a TLB tag. The operating system must set the `PID` field when switching processes, and before each TLB write operation.



Use of the process identifier is optional. To implement memory management without process identifiers, clear `tlbmisc.PID` to zero. Without a process identifier, all processes share the same virtual address space.

The MMU sets `tlbmisc.PID` on a TLB read operation. When the software triggers a TLB read, by setting `tlbmisc.RD` to one with the `wrc1` instruction, the `PID` value read from the TLB has priority over the value written by the `wrc1` instruction.

The size of the `PID` field is configured in SOPC Builder at system generation, and can be from 8 to 14 bits. If system software defines a process identifier smaller than the `PID` field, unused upper bits must be written as zero.

The DBL Flag

During a general exception, the processor sets `DBL` to one when a double TLB miss condition exists. Otherwise, the processor clears `DBL` to zero.

The `DBL` flag indicates whether the most recent exception is a double TLB miss condition. When a general exception occurs, the MMU sets `DBL` to one if a double TLB miss is detected, and clears `DBL` to zero otherwise.

The BAD Flag

During a general exception, the processor sets BAD to one when a bad virtual address condition exists, and clears BAD to zero otherwise. The following exceptions set the BAD flag to one:

- Supervisor-only instruction address
- Supervisor-only data address
- Misaligned data address
- Misaligned destination address

Refer to [Table 3-31 on page 3-26](#) for more information on these exceptions.

The PERM Flag

During a general exception, the processor sets PERM to one for a TLB permission violation exception, and clears PERM to zero otherwise.

The D Flag

The D flag indicates whether the exception is an instruction access exception or a data access exception. During a general exception, the processor sets D to one when the exception is related to a data access, and clears D to zero for all other non-break exceptions.

The following exceptions set the D flag to one:

- Fast TLB miss (data)
- Double TLB miss (data)
- TLB permission violation (read or write)
- Misaligned data address
- Supervisor-only data address

The badaddr Register

When the extra exception information option is enabled, the Nios II processor provides information useful to system software for exception processing in the `exception` and `badaddr` registers when an exception occurs. When your system contains an MMU or MPU, the extra exception information is always enabled. When no MMU or MPU is present, the Nios II Megawizard interface gives you the option to have the processor provide the extra exception information.

To see how to control the extra exception information option, refer to the *Instantiating the Nios II Processor in SOPC Builder* chapter of the *Nios II Processor Reference Handbook*.

When the option for extra exception information is enabled and a processor exception occurs, the `badaddr` register contains the byte instruction or data address associated with certain exceptions at the time the exception occurred. [Table 3-31 on page 3-26](#) shows which exceptions write the `badaddr` register along with the value written. [Table 3-19](#) shows the layout of the `badaddr` register.

Table 3-19. badaddr Control Register Fields

31	30	29	28	27	26	25	24	23	22	21	20	19	18	17	16	15	14	13	12	11	10	9	8	7	6	5	4	3	2	1	0
BADDR																															

Table 3-20 gives details of the fields defined in the badaddr register.

Table 3-20. badaddr Control Register Field Descriptions

Field	Description	Access	Reset	Available
BADDR	BADDR contains the byte instruction address or data address associated with an exception when certain exceptions occur. The Address column of Table 3-31 on page 3-26 shows which exceptions write the BADDR field.	Read	0	Only with extra exception information

The BADDR field allows up to a 32-bit instruction address or data address. If an MMU or MPU is present, the BADDR field is 32 bits because MMU and MPU instruction and data addresses are always full 32-bit values. When an MMU is present, the BADDR field contains the virtual address.

If there is no MMU or MPU and the Nios II address space is less than 32 bits, unused high-order bits are written and read as zero. If there is no MMU, bit 31 of a data address (used to bypass the data cache) is always zero in the BADDR field.

The config Register

The config register configures Nios II runtime behaviors that do not need to be preserved during exception processing (in contrast to the information in the status register). Table 3-21 shows the layout of the config register.

Table 3-21. config Control Register Fields

31	30	29	28	27	26	25	24	23	22	21	20	19	18	17	16	15	14	13	12	11	10	9	8	7	6	5	4	3	2	1	0
Reserved																															PE

Table 3-22 gives details of the fields defined in the config register

Table 3-22. config Control Register Field Descriptions

Field	Description	Access	Reset	Available
PE	PE is the memory protection enable bit. When PE =1, the MPU is enabled. When PE = 0, the MPU is disabled. In systems without an MPU, PE is always zero.	Read/Write	0	Only with MPU

The mpubase Register

The mpubase register works in conjunction with the mpuacc register to set and retrieve MPU region information and is only available in systems with an MPU. Table 3-23 shows the layout of the mpubase register.

Table 3–23. mpubase Control Register Fields

31	30	29	28	27	26	25	24	23	22	21	20	19	18	17	16	15	14	13	12	11	10	9	8	7	6	5	4	3	2	1	0
0						BASE (2)																INDEX (1)			D						

Notes to Table 3–23:

- (1) This field size is variable. Unused upper bits must be written as zero.
 (2) This field size is variable. Unused upper bits and unused lower bits must be written as zero.

Table 3–24 gives details of the fields defined in the mpubase register

Table 3–24. mpubase Control Register Field Descriptions

Field	Description	Access	Reset	Available
BASE	BASE is the base memory address of the region identified by the INDEX and D fields.	Read/Write	0	Only with MPU
INDEX	INDEX is the region index number.	Read/Write	0	Only with MPU
D	D is the region access bit. When D = 1, INDEX refers to a data region. When D = 0, INDEX refers to an instruction region.	Read/Write	0	Only with MPU

The BASE field specifies the base address of an MPU region. The 25-bit BASE field corresponds to bits 6 through 30 of the base address, making the base address always a multiple of 64 bytes. If the minimum region size set in SOPC Builder at generation time is larger than 64 bytes, unused low-order bits of the BASE field must be written as zero and are read as zero. For example, if the minimum region size is 1024 bytes, the four least-significant bits of the BASE field (bits 6 through 9 of the mpubase register) must be zero. Similarly, if the Nios II address space is less than 31 bits, unused high-order bits must also be written as zero and are read as zero.

The INDEX and D fields specify the region information to access when an MPU region read or write operation is performed. The D field specifies whether the region is a data region or an instruction region. The INDEX field specifies which of the 32 data or instruction regions to access. If there are fewer than 32 instruction or 32 data regions, unused high-order bits must be written as zero and are read as zero.

Refer to “MPU Region Read and Write Operations” on page 3–24 for more information on MPU region read and write operations.

The mpuacc Register

The mpuacc register works in conjunction with the mpubase register to set and retrieve MPU region information and is only available in systems with an MPU. The mpuacc register consists of attributes that will be set or have been retrieved which define the MPU region. The mpuacc register only holds a portion of the attributes that define an MPU region. The remaining portion of the MPU region definition is held by the BASE field of the mpubase register.

An SOPC Builder generation-time option controls whether the mpuacc register contains a MASK or LIMIT field. Table 3–25 shows the layout of the mpuacc register with the MASK field. Table 3–26 shows the layout of the mpuacc register with the LIMIT field.

Table 3-25. mpuacc Control Register Fields for MASK Variation

31	30	29	28	27	26	25	24	23	22	21	20	19	18	17	16	15	14	13	12	11	10	9	8	7	6	5	4	3	2	1	0									
0																									MASK (1)										C	PERM			RD	WR
Note to Table 3-25: (1) This field size is variable. Unused upper bits and unused lower bits must be written as zero.																																								

Table 3-26. mpuacc Control Register Fields for LIMIT Variation

31	30	29	28	27	26	25	24	23	22	21	20	19	18	17	16	15	14	13	12	11	10	9	8	7	6	5	4	3	2	1	0									
																									LIMIT (1)										C	PERM			RD	WR
Note to Table 3-26: (1) This field size is variable. Unused upper bits and unused lower bits must be written as zero.																																								

Table 3-27 gives details of the fields defined in the mpuacc register.

Table 3-27. mpuacc Control Register Field Descriptions

Field	Description	Access	Reset	Available
MASK (1)	MASK specifies the size of the region.	Read/Write	0	Only with MPU
LIMIT (1)	LIMIT specifies the upper address limit of the region.	Read/Write	0	Only with MPU
C	C is the data cacheable flag. C only applies to MPU data regions and determines the default cacheability of a data region. When C = 0, the data region is uncacheable. When C = 1, the data region is cacheable.	Read/Write	0	Only with MPU
PERM	PERM specifies the access permissions for the region.	Read/Write	0	Only with MPU
RD	RD is the read region flag. When RD = 1, wrctl instructions to the mpuacc register perform a read operation.	Write	0	Only with MPU
WE	WR is the write region flag. When WR = 1, wrctl instructions to the mpuacc register perform a write operation.	Write	0	Only with MPU
Note to Table 3-27: (1) The MASK and LIMIT fields are mutually exclusive. Refer to Table 3-25 and Table 3-26.				

The sections below provide further details of the mpuacc fields.

The MASK Field

When the amount of memory reserved for a region is defined by size, the MASK field specifies the size of the memory region. The MASK field is the same number of bits as the BASE field of the mpubase register.

 Unused high-order or low-order bits must be written as zero and are read as zero.

Table 3-28 shows the MASK field encodings for all possible region sizes in a full 31-bit byte address space.

Table 3–28. MASK Region Size Encodings

MASK Encoding	Region Size
0x1FFFFFFF	64 bytes
0x1FFFFFFE	128 bytes
0x1FFFFFFC	256 bytes
0x1FFFFFF8	512 bytes
0x1FFFFFF0	1 Kbyte
0x1FFFFFFE0	2 Kbytes
0x1FFFFFFC0	4 Kbytes
0x1FFFFFF80	8 Kbytes
0x1FFFFF00	16 Kbytes
0x1FFFE000	32 Kbytes
0x1FFFC000	64 Kbytes
0x1FFF8000	128 Kbytes
0x1FFF0000	256 Kbytes
0x1FFE0000	512 Kbytes
0x1FFC0000	1 Mbyte
0x1FF80000	2 Mbytes
0x1FF00000	4 Mbytes
0x1FE00000	8 Mbytes
0x1FC00000	16 Mbytes
0x1F800000	32 Mbytes
0x1F000000	64 Mbytes
0x1E000000	128 Mbytes
0x1C000000	256 Mbytes
0x18000000	512 Mbytes
0x10000000	1 Gbyte
0x00000000	2 Gbytes

Bit 31 of the `mpuacc` register is not used by the MASK field. Because memory region size is already a power of two, one less bit is needed. The MASK field contains the following value, where `region_size` is in bytes:

```
MASK = 0x1FFFFFFF << log2(region_size >> 6)
```

The LIMIT Field

When the amount of memory reserved for a region is defined by an upper address limit, the LIMIT field specifies the upper address of the memory region plus one. For example, to achieve a memory range for byte addresses `0x4000` to `0x4fff` with a 256 byte minimum region size, the BASE field of the `mpubase` register is set to `0x40` (`0x4000 >> 8`) and the LIMIT field is set to `0x50` (`0x5000 >> 8`). Because the LIMIT field is one more bit than the number of bits of the BASE field of the `mpubase` register, bit 31 of the `mpuacc` register is available to the LIMIT field.

The C Flag

The C flag determines the default data cacheability of an MPU region. The C flag only applies to data regions. For instruction regions, the C bit must be written with 0 and is always read as 0.

When data cacheability is enabled on a data region, a data access to that region can be cached, if a data cache is present in the system. You can override the default cacheability and force an address to non-cacheable with an `ldio` or `stio` instruction.



The bit 31 cache bypass feature is supported when the MPU is present. Refer to “Cache Memory” on page 3-38 for more information on cache bypass.

The PERM Field

The PERM field specifies the allowed access permissions. Table 3-29 shows possible values of the PERM field for instruction regions and Table 3-30 shows possible values of the PERM field for data regions.

Table 3-29. Instruction Region Permission Values

Value	Supervisor Permissions	User Permissions
0	None	None
1	Execute	None
2	Execute	Execute

Table 3-30. Data Region Permission Values

Value	Supervisor Permissions	User Permissions
0	None	None
1	Read	None
2	Read	Read
4	Read/Write	None
5	Read/Write	Read
6	Read/Write	Read/Write



Unlisted table values are reserved and must not be used. If you use reserved values, the resulting behavior is undefined.

The RD Flag

Setting the RD flag signifies that an MPU region read operation should be performed when a `wrctl` instruction is issued to the `mpuacc` register. Refer to “MPU Region Read and Write Operations” on page 3-24 for more information. The RD flag always returns 0 when read by a `rdctl` instruction.

The WR Flag

Setting the WR flag signifies that an MPU region write operation should be performed when a `wrctl` instruction is issued to the `mpuacc` register. Refer to “MPU Region Read and Write Operations” on page 3-24 for more information. The WR flag always returns 0 when read by a `rdctl` instruction.

 Setting both the RD and WR flags to one results in undefined behavior.

Working with the MPU

This section provides a basic overview of MPU initialization and the MPU region read and write operations.

MPU Region Read and Write Operations

MPU region read and write operations are operations that access MPU region attributes through the `mpubase` and `mpuacc` control registers. The `mpubase.BASE`, `mpuacc.MASK`, `mpuacc.LIMIT`, `mpuacc.C`, and `mpuacc.PERM` fields comprise the MPU region attributes.

MPU region read operations retrieve the current values for the attributes of a region. Each MPU region read operation consists of the following actions:

- Execute a `wrc1` instruction to the `mpubase` register with the `mpubase.INDEX` and `mpubase.D` fields set to identify the MPU region.
- Execute a `wrc1` instruction to the `mpuacc` register with the `mpuacc.RD` field set to one and the `mpuacc.WR` field cleared to zero. This action loads the `mpubase` and `mpuacc` register values.
- Execute a `rdc1` instruction to the `mpubase` register to read the loaded the `mpubase` register value.
- Execute a `rdc1` instruction to the `mpuacc` register to read the loaded the `mpuacc` register value.

The MPU region read operation retrieves `mpubase.BASE`, `mpuacc.MASK` or `mpuacc.LIMIT`, `mpuacc.C`, and `mpuacc.PERM` values for the MPU region.

 Values for the `mpubase` register are not actually retrieved until the `wrc1` instruction to the `mpuacc` register is performed.

MPU region write operations set new values for the attributes of a region. Each MPU region write operation consists of the following actions:

- Execute a `wrc1` instruction to the `mpubase` register with the `mpubase.INDEX` and `mpubase.D` fields set to identify the MPU region.
- Execute a `wrc1` instruction to the `mpuacc` register with the `mpuacc.WR` field set to one and the `mpuacc.RD` field cleared to zero.

The MPU region write operation sets the values for `mpubase.BASE`, `mpuacc.MASK` or `mpuacc.LIMIT`, `mpuacc.C`, and `mpuacc.PERM` as the new attributes for the MPU region.

Normally, a `wrc1` instruction flushes the pipeline to guarantee that any side effects of writing control registers take effect immediately after the `wrc1` instruction completes execution. However, `wrc1` instructions to the `mpubase` and `mpuacc` control registers do not automatically flush the pipeline. Instead, system software is responsible for flushing the pipeline as needed (either by using a `flushp` instruction or a `wrc1` instruction to a register that does flush the pipeline). Because a context switch typically requires reprogramming the MPU regions for the new thread, flushing the pipeline on each `wrc1` instruction would create unnecessary overhead.

MPU Initialization

Your system software must provide a data structure that contains the region information described in “[Memory Regions](#)” on page 3-8 for each active thread. The data structure ideally contains two 32-bit values that correspond to the `mpubase` and `mpuacc` register formats.

The MPU is disabled on system reset. Before enabling the MPU, Altera recommends initializing all MPU regions. Enable desired instruction and data regions by writing each region’s attributes to the `mpubase` and `mpuacc` registers as described in “[MPU Region Read and Write Operations](#)” on page 3-24. You must also disable unused regions. When using region size, clear `mpuacc.MASK` to zero. When using limit, set the `mpubase.BASE` to a non-zero value and clear `mpuacc.LIMIT` to zero.



You must enable at least one instruction and one data region, otherwise unpredictable behavior might occur.

To perform a context switch, use a `wrc1` to write a zero to the `PE` field of the `config` register to disable the MPU, define all MPU regions from the new thread’s data structure, and then use another `wrc1` to write a one to `config.PE` to enable the MPU.

Define each region using the pair of `wrc1` instructions described in “[MPU Region Read and Write Operations](#)” on page 3-24. Repeat this dual `wrc1` instruction sequence until all desired regions are defined.

Debugger Access

The debugger can access all MPU-related control registers using the normal `wrc1` and `rdc1` instructions. During debugging, the Nios II ignores the MPU, effectively temporarily disabling it.

Exception Processing

An exception is a transfer of control away from a program’s normal flow of execution, caused by an event, either internal or external to the processor, which requires immediate attention. Exception processing is the act of responding to an exception, and then returning to the pre-exception execution state.

Each of the Nios II exceptions falls into one of the following categories:

- Reset exceptions
- Break exceptions

- Interrupt exceptions
- Instruction-related exceptions

Table 3-31 shows all possible Nios II exceptions in order of highest to lowest priority. The following table columns specify information for the exceptions:

- Exception—Gives the name of the exception.
- Type—Specifies the exception type.
- Available—Specifies when support for that exception is present.
- Cause—Specifies the value of the CAUSE field of the exception register, for exceptions that write the exception.CAUSE field.
- Address—Specifies the instruction or data address associated with the exception.
- Vector—Specifies which exception vector address the processor passes control to when the exception occurs.

Table 3-31. Nios II Exceptions (In Decreasing Priority Order) (Part 1 of 2)

Exception	Type	Available	Cause	Address	Vector
Reset	Reset	Always	0		Reset
Hardware Break	Break	Always	—		Break
Processor-only Reset Request	Reset	Always	1		Reset
Interrupt	Interrupt	Always	2	ea-4 (2)	General exception
Supervisor-only Instruction Address (1)	Instruction-related	MMU	9	ea-4 (2)	General exception
Fast TLB Miss (instruction) (1)	Instruction-related	MMU	12	pteaddr.VPN, ea-4 (2)	Fast TLB Miss exception
Double TLB Miss (instruction) (1)	Instruction-related	MMU	12	pteaddr.VPN, ea-4 (2)	General exception
TLB Permission Violation (execute) (1)	Instruction-related	MMU	13	pteaddr.VPN, ea-4 (2)	General exception
MPU Region Violation (instruction) (1)	Instruction-related	MPU	16	ea-4 (2)	General exception
Supervisor-only Instruction	Instruction-related	MMU or MPU	10	ea-4 (2)	General exception
Trap Instruction	Instruction-related	Always	3	ea-4 (2)	General exception
Illegal Instruction	Instruction-related	Illegal instruction detection on, MMU, or MPU	5	ea-4 (2)	General exception
Unimplemented Instruction	Instruction-related	Always	4	ea-4 (2)	General exception
Break Instruction	Instruction-related	Always	—	ba-4 (2)	Break
Supervisor-only Data Address	Instruction-related	MMU	11	badaddr (data address)	General exception
Misaligned Data Address	Instruction-related	Illegal memory access detection on, MMU, or MPU	6	badaddr (data address)	General exception

Table 3-31. Nios II Exceptions (In Decreasing Priority Order) (Part 2 of 2)

Exception	Type	Available	Cause	Address	Vector
Misaligned Destination Address	Instruction-related	Illegal memory access detection on, MMU, or MPU	7	badaddr (destination address)	General exception
Division Error	Instruction-related	Division error detection on	8	ea-4 (2)	General exception
Fast TLB Miss (data)	Instruction-related	MMU	12	pteaddr.VPN, badaddr (data address)	Fast TLB Miss exception
Double TLB Miss (data)	Instruction-related	MMU	12	pteaddr.VPN, badaddr (data address)	General exception
TLB Permission Violation (read)	Instruction-related	MMU	14	pteaddr.VPN, badaddr (data address)	General exception
TLB Permission Violation (write)	Instruction-related	MMU	15	pteaddr.VPN, badaddr (data address)	General exception
MPU Region Violation (data)	Instruction-related	MPU	17	badaddr (data address)	General exception

Notes to Table 3-31:

- (1) It is possible for any instruction fetch to cause this exception.
- (2) Refer to Table 3-6 on page 3-11 for descriptions of the ea and ba registers.

The following sections describe each exception type in detail.

Reset Exceptions

When a processor reset signal is asserted, the Nios II processor performs the following steps:

1. Clears the `status` register to 0x0.
2. Invalidates the instruction-cache line associated with the reset vector.
3. Begins executing the reset handler, located at the reset vector.

Clearing the `status` register disables hardware interrupts. If the MMU or MPU is present, clearing the `status` register forces the processor into supervisor mode.

Invalidating the reset cache line guarantees that instruction fetches for reset code comes from uncached memory.

Aside from the instruction-cache line associated with the reset vector, the contents of the cache memories are indeterminate after reset. To ensure cache coherency after reset, the reset handler located at the reset vector must immediately initialize the instruction cache. Next, either the reset handler or a subsequent routine should proceed to initialize the data cache.

The reset state is undefined for all other system components, including but not limited to:

- General-purpose registers, except for `zero` (r0) which is permanently zero.

- Control registers, except for `status` which is reset to 0x0.
- Instruction and data memory.
- Cache memory, except for the instruction-cache line associated with the reset vector.
- Peripherals. Refer to the appropriate peripheral data sheet or specification for reset conditions.
- Custom instruction logic. Refer to the *Nios II Custom Instruction User Guide* for reset conditions.
- Nios II C-to-hardware (C2H) acceleration compiler logic.

Break Exceptions

A break is a transfer of control away from a program's normal flow of execution for the purpose of debugging. Software debugging tools can take control of the Nios II processor via the JTAG debug module.

Break processing is the means by which software debugging tools implement debug and diagnostic features, such as breakpoints and watchpoints. Break processing is a type of exception processing, but the break mechanism is independent from general exception processing. A break can occur during exception processing, enabling debug tools to debug exception handlers.

The processor enters the break processing state under either of the following conditions:

- The processor executes the `break` instruction. This is often referred to as a software break.
- The JTAG debug module asserts a hardware break.

Processing a Break

A break causes the processor to take the following steps:

1. Stores the contents of the `status` register to `bstatus`.
2. Clears `status.PIE` to zero, disabling external processor interrupts.
3. Writes the address of the instruction following the break to the `ba` register (`r30`).
4. Clears `status.U` to zero, forcing the processor into supervisor mode, when the system contains an MMU or MPU.
5. Sets `status.EH` to one, indicating the processor is handling an exception, when the system contains an MMU.
6. Transfers execution to the break handler, stored at the break vector specified at system generation time.

Register Usage

The `bstatus` control register and general-purpose registers `bt` (`r25`) and `ba` (`r30`) are reserved for debugging. Code is not prevented from writing to these registers, but debug code might overwrite the values. The break handler can use `bt` (`r25`) to help save additional registers.

Returning From a Break

After processing a break, the break handler releases control of the processor by executing a `bret` instruction. The `bret` instruction restores `status` by copying the contents of `bstatus` and returns program execution to the address in the `ba` register (`r30`). Aside from `bt`, all registers are guaranteed to be returned to their pre-break state after returning from the break handler.

Interrupt Exceptions

An external source such as a peripheral device can request a hardware interrupt by asserting one of the processor's 32 interrupt-request inputs, `irq0` through `irq31`. A hardware interrupt is generated if and only if all three of these conditions are true:

- The `PIE` bit of the `status` control register is one.
- An interrupt-request input, `irqn`, is asserted.
- The corresponding bit `n` of the `ienable` control register is one.

Upon hardware interrupt, the processor clears the `PIE` bit to zero, disabling further interrupts, and performs the other steps outlined in “[Processing Interrupt and Instruction-Related Exceptions](#)” on page 3-35.

The value of the `ipending` control register shows which interrupt requests (IRQ) are pending. By peripheral design, an IRQ bit is guaranteed to remain asserted until the processor explicitly responds to the peripheral. [Figure 3-2](#) shows the relationship between `ipending`, `ienable`, `PIE`, and the generation of an interrupt.

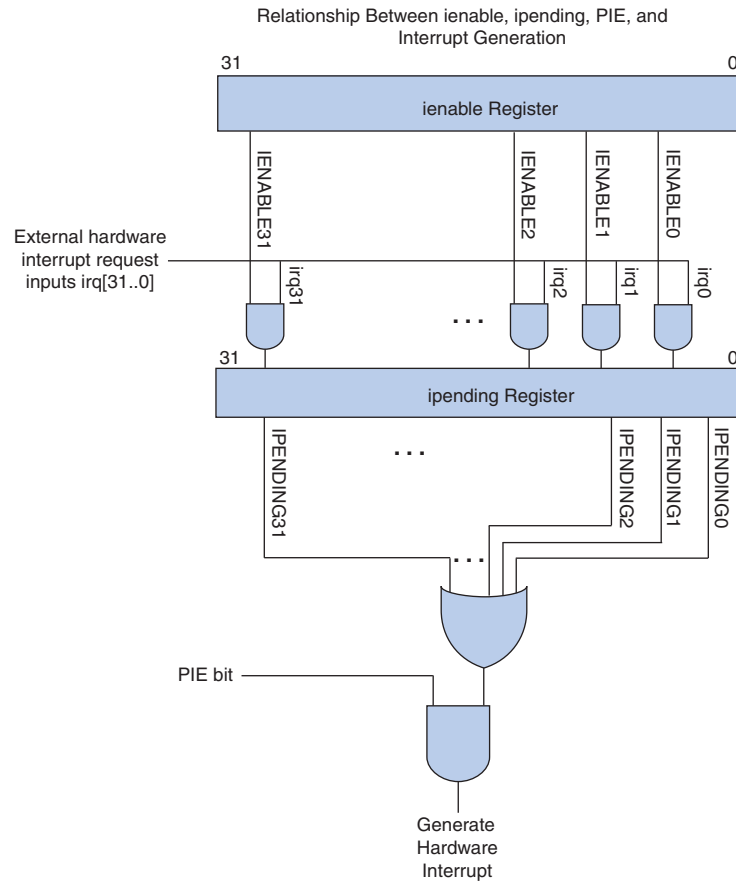
Figure 3–2. Relationship Between `ienable`, `ipending`, `PIE` and Hardware Interrupts

A software exception routine determines which of the pending interrupts has the highest priority, and then transfers control to the appropriate interrupt service routine (ISR). The ISR stops the interrupt from being visible (either by clearing it at the source or masking it using `ienable`) before returning and/or before re-enabling `PIE`. The ISR also saves `estatus` and `ea` (`r29`) before re-enabling `PIE`.

Interrupts can be re-enabled by writing one to the `PIE` bit, thereby allowing the current ISR to be interrupted. Typically, the exception routine adjusts `ienable` so that IRQs of equal or lower priority are disabled before re-enabling interrupts. Refer to “[Nested Exception Precautions](#)” on page 3–37 for more information.

Instruction-Related Exceptions

Instruction-related exceptions occur during execution of Nios II instructions and perform the steps outlined in “[Processing Interrupt and Instruction-Related Exceptions](#)” on page 3–35.

The Nios II processor generates the following instruction-related exceptions. All instruction-related exceptions are precise.

- Trap instruction
- Break instruction

- Unimplemented instruction
- Illegal instruction
- Supervisor-only instruction
- Supervisor-only instruction address
- Supervisor-only data address
- Misaligned data address
- Misaligned destination address
- Division error
- Fast TLB miss
- Double TLB miss
- TLB permission violation
- MPU region violation

Trap Instruction

When a program issues the `trap` instruction, it generates a software trap exception. A program typically issues a software trap when the program requires servicing by the operating system. The general exception handler for the operating system determines the reason for the trap and responds appropriately.

Break Instruction

The break instruction is treated as a break exception. Refer to [“Break Exceptions” on page 3-28](#) for details.

Unimplemented Instruction

When the processor issues a valid instruction that is not implemented in hardware, an unimplemented instruction exception is generated. The general exception handler determines which instruction generated the exception. If the instruction is not implemented in hardware, control is passed to an exception routine that might choose to emulate the instruction in software. Refer to [“Potential Unimplemented Instructions” on page 3-44](#) for more information.

Illegal Instruction

Illegal instructions are instructions with an undefined opcode or opcode-extension field. The Nios II processor can check for illegal instructions and generate an exception when an illegal instruction is encountered. When your system contains an MMU or MPU, illegal instruction checking is always on. When no MMU or MPU is present, you have the option to have the processor check for illegal instructions.



To see how to control this option, refer to the [Instantiating the Nios II Processor in SOPC Builder](#) chapter of the *Nios II Processor Reference Handbook*.

When the processor issues an instruction with an undefined opcode or opcode-extension field, and illegal instruction exception checking is turned on, an illegal instruction exception is generated.

 Refer to the OP Encodings and OPX Encodings for R-Type Instructions tables in the *Instruction Set Reference* chapter of the *Nios II Processor Reference Handbook* to see the unused opcodes and opcode extensions.

 All undefined opcodes are reserved. The processor does occasionally use some undefined encodings internally. Executing one of these undefined opcodes does not trigger an illegal instruction exception. Refer to the *Nios II Core Implementation Details* chapter of the *Nios II Processor Reference Handbook* for details on each specific Nios II core.

Supervisor-only Instruction

When your system contains an MMU or MPU and the processor is in user mode (`status.U = 1`), executing a supervisor-only instruction results in a supervisor-only instruction exception. The supervisor-only instructions are `initd`, `initi`, `eret`, `bret`, `rdctl`, and `wrctl`.

This exception is implemented only in Nios II processors configured to use supervisor mode and user mode. Refer to “[Operating Modes](#)” on page 3-2 for more information.

Supervisor-only Instruction Address

When your system contains an MMU and the processor is in user mode (`status.U = 1`), attempts to access a supervisor-only instruction address result in a supervisor-only instruction address exception. Any instruction fetch can cause this exception. For definitions of supervisor-only address ranges, refer to [Table 3-2 on page 3-5](#).

This exception is implemented only in Nios II processors that include the MMU.

Supervisor-only Data Address

When your system contains an MMU and the processor is in user mode (`status.U = 1`), any attempt to access a supervisor-only data address results in a supervisor-only data address exception. Instructions that can cause a supervisor-only data address exception are all loads, all stores, and `flushda`.

This exception is implemented only in Nios II processors that include the MMU.

Misaligned Data Address

The Nios II processor can check for misaligned data addresses of load and store instructions and generate an exception when a misaligned data address is encountered. When your system contains an MMU or MPU, misaligned data address checking is always on. When no MMU or MPU is present, you have the option to have the processor check for misaligned data addresses.

 To see how to control this option, refer to the *Instantiating the Nios II Processor in SOPC Builder* chapter of the *Nios II Processor Reference Handbook*.

A data address is considered misaligned if the byte address is not a multiple of the width of the load or store instruction data width (four bytes for word, two bytes for half-word). Byte load and store instructions are always aligned so never take a misaligned address exception.

Misaligned Destination Address

The Nios II processor can check for misaligned destination addresses of the `callr`, `jmp`, `ret`, `eret`, `bret`, and all branch instructions and generate an exception when a misaligned destination address is encountered. When your system contains an MMU or MPU, misaligned destination address checking is always on. When no MMU or MPU is present, you have the option to have the processor check for misaligned destination addresses.

 To see how to control this option, refer to the *Instantiating the Nios II Processor in SOPC Builder* chapter of the *Nios II Processor Reference Handbook*.

A destination address is considered misaligned if the target byte address of the instruction is not a multiple of four.

Division Error

The Nios II processor can check for division errors and generate an exception when a division error is encountered.

 To see how to control this option, refer to the *Instantiating the Nios II Processor in SOPC Builder* chapter of the *Nios II Processor Reference Handbook*.

The division error exception detects divide instructions that produce a quotient that can't be represented. The two cases are divide by zero and a signed division that divides the largest negative number -2147483648 (0x80000000) by -1 (0xffffffff). Division error detection is only available if divide instructions are supported by hardware.

Fast TLB Miss

Fast TLB miss exceptions are implemented only in Nios II processors that include the MMU. The MMU has a special exception vector (fast TLB miss), specified in SOPC Builder at system generation time, specifically to handle TLB miss exceptions quickly. Whenever the processor cannot find a TLB entry matching the VPN (optionally extended by a process identifier), the result is a TLB miss exception. At the time of the exception, the processor first checks `status.EH`. When `status.EH = 0`, no other exception is already in process, so the processor considers the TLB miss a fast TLB miss, sets `status.EH` to one, and transfers control to the fast TLB miss exception handler (rather than to the general exception handler).

There are two kinds of fast TLB miss exceptions:

- Fast TLB miss (instruction)—Any instruction fetch can cause this exception.
- Fast TLB miss (data)—Load, store, `initda`, and `flushda` instructions can cause this exception.

The fast TLB miss exception handler can inspect the `tlbmisc.D` field to determine which kind of fast TLB miss exception occurred.

Double TLB Miss

Double TLB miss exceptions are implemented only in Nios II processors that include the MMU. When a TLB miss exception occurs while software is currently processing an exception (that is, when `status.EH = 1`), a double TLB miss exception is generated. Specifically, whenever the processor cannot find a TLB entry matching the VPN (optionally extended by a process identifier) and `status.EH = 1`, the result is a double TLB miss exception. The most common scenario is that a double TLB miss exception occurs during processing of a fast TLB miss exception. The processor preserves register values from the original exception and transfers control to the general exception handler which processes the newly-generated exception.

There are two kinds of double TLB miss exceptions:

- Double TLB miss (instruction)—Any instruction fetch can cause this exception.
- Double TLB miss (data)—Load, store, `initda`, and `flushda` instructions can cause this exception.

The general exception handler can inspect either the `exception.CAUSE` or `tlbmisc.D` field to determine which kind of double TLB miss exception occurred.

TLB Permission Violation

TLB permission violation exceptions are implemented only in Nios II processors that include the MMU. When a TLB entry is found matching the VPN (optionally extended by a process identifier), but the permissions do not allow the access to complete, a TLB permission violation exception is generated.

There are three kinds of TLB permission violation exceptions:

- TLB permission violation (execute)—Any instruction fetch can cause this exception.
- TLB permission violation (read)—Any load instruction can cause this exception.
- TLB permission violation (write)—Any store instruction can cause this exception.

The general exception handler can inspect the `exception.CAUSE` field to determine which permissions were violated.



The data cache management instructions (`initd`, `initda`, `flushd`, and `flushda`) ignore the TLB permissions and do not generate TLB permission violation exceptions.

MPU Region Violation

MPU region violation exceptions are implemented only in Nios II processors that include the MPU. An MPU region violation exception is generated under any of the following conditions:

- An instruction fetch or data address matched a region but the permissions for that region did not allow the action to complete.
- An instruction fetch or data address did not match any region.

The general exception handler reads the MPU region attributes to determine if the address did not match any region or which permissions were violated.

There are two kinds of MPU region violation exceptions:

- MPU region violation (instruction)—Any instruction fetch can cause this exception.
- MPU region violation (data)—Load, store, `initda`, and `flushda` instructions can cause this exception.

The general exception handler can inspect the `exception.CAUSE` field to determine which kind of MPU region violation exception occurred.

Other Exceptions

The previous sections describe all of the exception types defined by the Nios II architecture at the time of publishing. However, some processor implementations might generate exceptions that do not fall into the above categories. Therefore, a robust exception handler must provide a safe response (such as issuing a warning) in the event that it cannot identify the cause of an exception.

Processing Interrupt and Instruction-Related Exceptions

Except for the break instruction (refer to “[Processing a Break](#)” on page 3-28), this section describes the actions the processor takes in response to interrupt and instruction-related exceptions. [Table 3-32](#) lists all possible non-break exception processing actions performed by hardware. Check marks indicate which actions apply to each of the processor scenarios, namely, systems without an MMU, systems with an MMU, and systems with an MMU that is currently processing an exception. For systems with an MMU, `status.EH` indicates whether or not exception processing is already in progress. When `status.EH = 1`, exception processing is already in progress and the states of the exception registers are preserved to retain the original exception states.

Table 3-32. Non-Break Exception Processing Actions (Part 1 of 2)

Processor Actions (in order of occurrence)	No MMU	MMU and EH = 0	MMU and EH = 1
Copies the contents of the <code>status</code> control register to the <code>estatus</code> control register, saving the processor’s pre-exception status.	✓	✓	
Clears <code>status.PIE</code> to zero, disabling external processor interrupts.	✓	✓	✓
Writes the address of the instruction following the exception to the <code>ea</code> register (<code>r29</code>).	✓	✓	
Clears <code>status.U</code> to zero, forcing the processor into supervisor mode.		✓	✓
Sets <code>status.EH</code> to one, indicating the processor is handling an exception.		✓	
If fast TLB miss or a TLB permission violation exception, writes the VPN of the address triggering the exception to <code>pteaddr.VPN</code> .		✓	
Conditionally writes to <code>tlbmisc.D</code> . Refer to “ The D Flag ” on page 3-18 for more information.		✓	
Conditionally writes to <code>tlbmisc.DBL</code> . Refer to “ The DBL Flag ” on page 3-17 for more information.		✓	✓
Conditionally writes to <code>tlbmisc.PERM</code> . Refer to “ The PERM Flag ” on page 3-18 for more information.		✓	✓
Conditionally writes to <code>tlbmisc.BAD</code> . Refer to “ The BAD Flag ” on page 3-18 for more information.		✓	✓

Table 3-32. Non-Break Exception Processing Actions (Part 2 of 2)

Processor Actions (in order of occurrence)	No MMU	MMU and EH = 0	MMU and EH = 1
Passes control to the general exception vector, invoking the general exception handler	✓		✓
Passes control to an exception handler: <ul style="list-style-type: none"> ■ If the exception is a TLB miss, control passes to the fast TLB miss exception vector, invoking the fast TLB miss handler. ■ If the exception is not a TLB miss, control passes to the general exception vector, invoking the general exception handler 		✓	

The fast TLB miss exception handler is a routine that handles only the fast TLB miss exception. It is built for speed to process TLB misses quickly.

The general exception handler is a routine that determines the cause of each exception (including the double TLB miss exception), and then dispatches an exception routine to respond to the exception. The address of the general exception handler, specified in SOPC Builder at system generation time, is called the exception vector in the Nios II Megawizard interface. At run time this address is fixed, and software cannot modify it. Programmers do not directly access exception vectors, and can write programs without awareness of the address.

The fast TLB miss exception handler only handles the fast TLB miss exception. The fast TLB miss exception handler address, specified in SOPC Builder at system generation time, is called the fast TLB miss exception vector in the Nios II Megawizard interface.



For a detailed discussion of writing programs to take advantage of exception and interrupt handling, refer to the *Exception Handling* chapter of the *Nios II Software Developer's Handbook*.

Determining the Cause of Interrupt and Instruction-Related Exceptions

The general exception handler must determine the cause of each exception and then transfer control to an appropriate exception routine.

With Extra Exception Information

When you have included the extra exception information in your Nios II system, the CAUSE field of the `exception` register (refer to “[The exception Register](#)” on [page 3-13](#)) contains a code for the highest-priority exception occurring at the time and the BADDR field of the `badaddr` register (refer to “[The badaddr Register](#)” on [page 3-18](#)) contains the byte instruction address or data address for certain exceptions. Refer to [Table 3-31 on page 3-26](#) for more information.

To determine the cause of an exception, simply read the cause of the exception from `exception.CAUSE` and then transfer control to the appropriate exception routine.



Extra exception information is always enabled in Nios II systems containing an MMU or MPU.

Without Extra Exception Information

When you have not included the extra exception information in your Nios II system, your exception handler must determine the cause of exception itself. For this reason, Altera recommends always enabling the extra exception information.

When the extra exception information is not available, use the following sequence to determine the cause of an exception:

```
/* Check for interrupt exceptions first*/
if (estatus.EPIE == 1 and ipending != 0) {
    handle interrupt

/* Decode exception from instruction */
/* Note: Because the exception register is included with the MMU and */
/* MPU, you never need to determine MMU or MPU exceptions by decoding */
} else {
    decode instruction at $ea-4
    if (instruction is trap)
        handle trap exception
    else if (instruction is load or store)
        handle misaligned data address exception
    else if (instruction is branch, bret, callr, eret, jmp, or ret)
        handle misaligned destination address exception
    else if (instruction is unimplemented)
        handle unimplemented instruction exception
    else if (instruction is illegal)
        handle illegal instruction exception
    else if (instruction is divide) {
        if (denominator == 0)
            handle division error exception
        else if (instruction is signed divide and numerator == 0x80000000
            and denominator == 0xffffffff)
            handle division error exception
    }
}

/* Not any known exception */
} else {
    handle unknown exception (could be spurious interrupt)
}
}
```

Nested Exception Precautions

Exception routines must take special precautions before any of the following actions:

- Issuing a trap instruction
- Issuing a potentially unimplemented instruction
- Re-enabling hardware interrupts



For details about unimplemented instructions, refer to the *Processor Architecture* chapter of the *Nios II Processor Reference Handbook*.

Before allowing any of these actions, the exception routine must save `estatus` and `ea` (r29), then restore them properly before returning to preserve the pre-exception state of the exception registers.

Returning From Interrupt and Instruction-Related Exceptions

The `eret` instruction is used to resume execution at the pre-exception address. Except for the `et` register (r24), the exception routine must restore any registers modified during exception processing before returning.

When executing the `eret` instruction, the processor performs the following tasks:

1. Copies the contents of `estatus` to `status`
2. Transfers program execution to the address in the `ea` register (r29)

Return Address Considerations

The return address requires some consideration when returning from exception processing routines. After an exception occurs, `ea` contains the address of the instruction following the point where the exception occurred.

When returning from instruction-related exceptions, execution must resume from the instruction following the instruction where the exception occurred. Therefore, `ea` contains the correct return address.

On the other hand, hardware interrupt exceptions must resume execution from the interrupted instruction itself. In this case, the exception handler must subtract 4 from `ea` to point to the interrupted instruction.

Memory and Peripheral Access

Nios II addresses are 32 bits, allowing access up to a 4 gigabyte address space. Nios II core implementations without MMUs restrict addresses to 31 bits or fewer. The MMU supports the full 32-bit physical address.



For details, refer to the *Nios II Core Implementation Details* chapter of the *Nios II Processor Reference Handbook*.

Peripherals, data memory, and program memory are mapped into the same address space. The locations of memory and peripherals within the address space are determined at system generation time. Reading or writing to an address that does not map to a memory or peripheral produces an undefined result.

The processor's data bus is 32 bits wide. Instructions are available to read and write byte, half-word (16-bit), or word (32-bit) data.

The Nios II architecture is little endian. For data wider than 8 bits stored in memory, the more-significant bits are located in higher addresses.

The Nios II architecture supports register+immediate addressing.

Cache Memory

The Nios II architecture and instruction set accommodate the presence of data cache and instruction cache memories. Cache management is implemented in software by using cache management instructions. Instructions are provided to initialize the cache, flush the caches whenever necessary, and to bypass the data cache to properly access memory-mapped peripherals.

The Nios II architecture provides the following mechanisms to bypass the cache:

- When no MMU is present, bit 31 of the address is reserved for bit-31 cache bypass. With bit-31 cache bypass, the address space of processor cores is 2 GBytes, and the high bit of the address controls the caching of data memory accesses.
- When the MMU is present, cacheability is controlled by the MMU, and bit 31 functions as a normal address bit. For details, refer to “[Address Space and Memory Partitions](#)” on page 3-4, and “[TLB Organization](#)” on page 3-6.
- Cache bypass instructions, such as `ldwio` and `stwio`.

Refer to the *Nios II Core Implementation Details* chapter of the *Nios II Processor Reference Handbook* for details of which processor cores implement bit-31 cache bypass. Refer to *Instruction Set Reference* chapter of the *Nios II Processor Reference Handbook* for details of the cache bypass instructions.

Code written for a processor core with cache memory behaves correctly on a processor core without cache memory. The reverse is not true. If it is necessary for a program to work properly on multiple Nios II processor core implementations, the program must behave as if the instruction and data caches exist. In systems without cache memory, the cache management instructions perform no operation, and their effects are benign.

For a complete discussion of cache management, refer to the *Cache and Tightly Coupled Memory* chapter of the *Nios II Software Developer's Handbook*.

Some consideration is necessary to ensure cache coherency after processor reset. Refer to “[Reset Exceptions](#)” on page 3-27 for more information.

For details on the cache architecture and the memory hierarchy refer to the *Processor Architecture* chapter of the *Nios II Processor Reference Handbook*.

Virtual Address Aliasing

A virtual address alias occurs when two virtual addresses map to the same physical address. When an MMU and caches are present and the caches are larger than a page (4 KBytes), the operating system must prevent illegal virtual address aliases. Because the caches are virtually-indexed and physically-tagged, a portion of the virtual address is used to select the cache line. If the cache is 4 KBytes or less in size, the portion of the virtual address used to select the cache line fits with bits 11:0 of the virtual address which have the same value as bits 11:0 of the physical address (they are untranslated bits of the page offset). However, if the cache is larger than 4 KBytes, bits beyond the page offset (bits 12 and up) are used to select the cache line and these bits are allowed to be different than the corresponding physical address.

For example, in a 64 KByte direct-mapped cache with a 16-byte line, bits 15:4 are used to select the line. Assume that virtual address `0x1000` is mapped to physical address `0xF000` and virtual address `0x2000` is also mapped to physical address `0xF000`. This is an illegal virtual address alias because accesses to virtual address `0x1000` use line `0x1` and accesses to virtual address `0x2000` use line `0x2` even though they map to the same physical address. This results in two copies of the same physical address in the cache. With an n -byte direct-mapped cache, there could be $n/4096$ copies of the same physical address in the cache if illegal virtual address aliases are not prevented. The bits of the virtual address that are used to select the line and are translated bits

(bits 12 and up) are known as the color of the address. An operating system avoids illegal virtual address aliases by ensuring that if multiple virtual addresses map the same physical address, the virtual addresses have the same color. Note though, the color of the virtual addresses does not need to be the same as the color as the physical address because the cache tag contains all the bits of the PFN.

Instruction Set Categories

This section introduces the Nios II instructions categorized by type of operation performed.

Data Transfer Instructions

The Nios II architecture is a load-store architecture. Load and store instructions handle all data movement between registers, memory, and peripherals. Memories and peripherals share a common address space. Some Nios II processor cores use memory caching and/or write buffering to improve memory bandwidth. The architecture provides instructions for both cached and uncached accesses.

Table 3-33 describes the wide (32-bit) load and store instructions.

Table 3-33. Wide Data Transfer Instructions

Instruction	Description
ldw stw	The ldw and stw instructions load and store 32-bit data words from/to memory. The effective address is the sum of a register's contents and a signed immediate value contained in the instruction. Memory transfers can be cached or buffered to improve program performance. This caching and buffering might cause memory cycles to occur out of order, and caching might suppress some cycles entirely. Data transfers for I/O peripherals should use ldwio and stwio.
ldwio stwio	ldwio and stwio instructions load and store 32-bit data words from/to peripherals without caching and buffering. Access cycles for ldwio and stwio instructions are guaranteed to occur in instruction order and are never suppressed.

The data transfer instructions in Table 3-34 support byte and half-word transfers.

Table 3-34. Narrow Data Transfer Instructions

Instruction	Description
ldb ldbu stb ldh ldhu sth	ldb, ldbu, ldh and ldhu load a byte or half-word from memory to a register. ldb and ldh sign-extend the value to 32 bits, and ldbu and ldhu zero-extend the value to 32 bits. stb and sth store byte and half-word values, respectively. Memory accesses can be cached or buffered to improve performance. To transfer data to I/O peripherals, use the "io" versions of the instructions, described below.
ldbio ldbuio stbio ldhio ldhuio sthio	These operations load/store byte and half-word data from/to peripherals without caching or buffering.

Arithmetic and Logical Instructions

Logical instructions support `and`, `or`, `xor`, and `nor` operations. Arithmetic instructions support addition, subtraction, multiplication, and division operations. Refer to [Table 3-35](#).

Table 3-35. Arithmetic and Logical Instructions

Instruction	Description
<code>and</code> <code>or</code> <code>xor</code> <code>nor</code>	These are the standard 32-bit logical operations. These operations take two register values and combine them bit-wise to form a result for a third register.
<code>andi</code> <code>ori</code> <code>xori</code>	These operations are immediate versions of the <code>and</code> , <code>or</code> , and <code>xor</code> instructions. The 16-bit immediate value is zero-extended to 32 bits, and then combined with a register value to form the result.
<code>andhi</code> <code>orhi</code> <code>xorhi</code>	In these versions of <code>and</code> , <code>or</code> , and <code>xor</code> , the 16-bit immediate value is shifted logically left by 16 bits to form a 32-bit operand. Zeroes are shifted in from the right.
<code>add</code> <code>sub</code> <code>mul</code> <code>div</code> <code>divu</code>	These are the standard 32-bit arithmetic operations. These operations take two registers as input and store the result in a third register.
<code>addi</code> <code>subi</code> <code>muli</code>	These instructions are immediate versions of the <code>add</code> , <code>sub</code> , and <code>mul</code> instructions. The instruction word includes a 16-bit signed value.
<code>mulxss</code> <code>mulxuu</code>	These instructions provide access to the upper 32 bits of a 32x32 multiplication operation. Choose the appropriate instruction depending on whether the operands should be treated as signed or unsigned values. It is not necessary to precede these instructions with a <code>mul</code> .
<code>mulxsu</code>	This instruction is used in computing a 128-bit result of a 64x64 signed multiplication.

Move Instructions

These instructions provide move operations to copy the value of a register or an immediate value to another register. Refer to [Table 3-36](#).

Table 3-36. Move Instructions

Instruction	Description
<code>mov</code> <code>movhi</code> <code>movi</code> <code>movui</code> <code>movia</code>	<code>mov</code> copies the value of one register to another register. <code>movi</code> moves a 16-bit signed immediate value to a register, and sign-extends the value to 32 bits. <code>movui</code> and <code>movhi</code> move an immediate 16-bit value into the lower or upper 16-bits of a register, inserting zeros in the remaining bit positions. Use <code>movia</code> to load a register with an address.

Comparison Instructions

The Nios II architecture supports a number of comparison instructions. All of these compare two registers or a register and an immediate value, and write either one (if true) or zero to the result register. These instructions perform all the equality and relational operators of the C programming language. Refer to [Table 3-37](#).

Table 3-37. Comparison Instructions

Instruction	Description
<code>cmpeq</code>	<code>==</code>
<code>cmpne</code>	<code>!=</code>
<code>cmpge</code>	signed <code>>=</code>
<code>cmpgeu</code>	unsigned <code>>=</code>
<code>cmpgt</code>	signed <code>></code>
<code>cmpgtu</code>	unsigned <code>></code>
<code>cmple</code>	unsigned <code><=</code>
<code>cmpleu</code>	unsigned <code><=</code>
<code>cmplt</code>	signed <code><</code>
<code>cmpltu</code>	unsigned <code><</code>
<code>cmpeqi</code> <code>cmpnei</code> <code>cmpgei</code> <code>cmpgeui</code> <code>cmpgti</code> <code>cmpgtui</code> <code>cmplei</code> <code>cmpleui</code> <code>cmplti</code> <code>cmpltui</code>	These instructions are immediate versions of the comparison operations. They compare the value of a register and a 16-bit immediate value. Signed operations sign-extend the immediate value to 32-bits. Unsigned operations fill the upper bits with zero.

Shift and Rotate Instructions

The following instructions provide shift and rotate operations. The number of bits to rotate or shift can be specified in a register or an immediate value. Refer to [Table 3-38](#).

Table 3-38. Shift and Rotate Instructions

Instruction	Description
<code>rol</code> <code>ror</code> <code>roli</code>	The <code>rol</code> and <code>roli</code> instructions provide left bit-rotation. <code>roli</code> uses an immediate value to specify the number of bits to rotate. The <code>ror</code> instructions provides right bit-rotation. There is no immediate version of <code>ror</code> , because <code>roli</code> can be used to implement the equivalent operation.
<code>sll</code> <code>slli</code> <code>sra</code> <code>srl</code> <code>srai</code> <code>srl</code>	These shift instructions implement the <code><<</code> and <code>>></code> operators of the C programming language. The <code>sll</code> , <code>slli</code> , <code>srl</code> , <code>srl</code> instructions provide left and right logical bit-shifting operations, inserting zeros. The <code>sra</code> and <code>srai</code> instructions provide arithmetic right bit-shifting, duplicating the sign bit in the most significant bit. <code>slli</code> , <code>srl</code> and <code>srai</code> use an immediate value to specify the number of bits to shift.

Program Control Instructions

The Nios II architecture supports the unconditional jump and call instructions listed in [Table 3-39](#). These instructions do not have delay slots.

Table 3-39. Unconditional Jump and Call Instructions

Instruction	Description
call	This instruction calls a subroutine using an immediate value as the subroutine's absolute address, and stores the return address in register <i>ra</i> .
callr	This instruction calls a subroutine at the absolute address contained in a register, and stores the return address in register <i>ra</i> . This instruction serves the roll of dereferencing a C function pointer.
ret	The <code>ret</code> instruction is used to return from subroutines called by <code>call</code> or <code>callr</code> . <code>ret</code> loads and executes the instruction specified by the address in register <i>ra</i> .
jmp	The <code>jmp</code> instruction jumps to an absolute address contained in a register. <code>jmp</code> is used to implement switch statements of the C programming language.
jmp _i	The <code>jmp_i</code> instruction jumps to an absolute address using an immediate value to determine the absolute address.
or	This instruction branches relative to the current instruction. A signed immediate value gives the offset of the next instruction to execute.

The conditional-branch instructions compare register values directly, and branch if the expression is true. Refer to [Table 3-40](#). The conditional branches support the equality and relational comparisons of the C programming language:

- == and !=
- < and <= (signed and unsigned)
- > and >= (signed and unsigned)

The conditional-branch instructions do not have delay slots.

Table 3-40. Conditional-Branch Instructions

Instruction	Description
bge bgeu bgt bgtu ble bleu blt bltu beq bne	These instructions provide relative branches that compare two register values and branch if the expression is true. Refer to “Comparison Instructions” on page 3-41 for a description of the relational operations implemented.

Other Control Instructions

[Table 3-41](#) shows other control instructions.

Table 3-41. Other Control Instructions

Instruction	Description
trap eret	The <code>trap</code> and <code>eret</code> instructions generate and return from exceptions. These instructions are similar to the <code>call/ret</code> pair, but are used for exceptions. <code>trap</code> saves the <code>status</code> register in the <code>estatus</code> register, saves the return address in the <code>ea</code> register, and then transfers execution to the general exception handler. <code>eret</code> returns from exception processing by restoring <code>status</code> from <code>estatus</code> , and executing the instruction specified by the address in <code>ea</code> .
break bret	The <code>break</code> and <code>bret</code> instructions generate and return from breaks. <code>break</code> and <code>bret</code> are used exclusively by software debugging tools. Programmers never use these instructions in application code.
rdctl wrctl	These instructions read and write control registers, such as the <code>status</code> register. The value is read from or stored to a general-purpose register.
flushd flushda flushi initd initda initi	These instructions are used to manage the data and instruction cache memories.
flushp	This instruction flushes all pre-fetched instructions from the pipeline. This is necessary before jumping to recently-modified instruction memory.
sync	This instruction ensures that all previously-issued operations have completed before allowing execution of subsequent load and store operations.

Custom Instructions

The `custom` instruction provides low-level access to custom instruction logic. The inclusion of custom instructions is specified in SOPC Builder at system generation time, and the function implemented by custom instruction logic is design dependent.

 For further details, refer to the “Custom Instructions” section of the *Processor Architecture* chapter of the *Nios II Processor Reference Handbook* and the *Nios II Custom Instruction User Guide*.

Machine-generated C functions and assembly macros provide access to custom instructions, and hide implementation details from the user. Therefore, most software developers never use the `custom` assembly instruction directly.

No-Operation Instruction

The Nios II assembler provides a no-operation instruction, `nop`.

Potential Unimplemented Instructions

Some Nios II processor cores do not support all instructions in hardware. In this case, the processor generates an exception after issuing an unimplemented instruction. Only the following instructions can generate an unimplemented instruction exception:

- `mul`
- `muli`
- `mulxss`

- mulxsu
- mulxuu
- div
- divu
- initda

All other instructions are guaranteed not to generate an unimplemented instruction exception.

An exception routine must exercise caution if it uses these instructions, because they could generate another exception before the previous exception is properly handled. Refer to “[Unimplemented Instruction](#)” on page 3-31 for more information regarding unimplemented instruction processing.

Referenced Documents

This chapter references the following documents:

- *Nios II Software Developer’s Handbook*
- *Processor Architecture* chapter of the *Nios II Processor Reference Handbook*
- *Application Binary Interface* chapter of the *Nios II Processor Reference Handbook*
- *Instruction Set Reference* chapter of the *Nios II Processor Reference Handbook*
- *Instantiating the Nios II Processor in SOPC Builder* chapter of the *Nios II Processor Reference Handbook*
- *Nios II Core Implementation Details* chapter of the *Nios II Processor Reference Handbook*
- *Exception Handling* chapter of the *Nios II Software Developer’s Handbook*
- *Cache and Tightly Coupled Memory* chapter of the *Nios II Software Developer’s Handbook*
- *Processor Architecture* chapter of the *Nios II Processor Reference Handbook*
- *Nios II Custom Instruction User Guide*

Document Revision History

Table 3-42 shows the revision history for this document.

Table 3-42. Document Revision History (Part 1 of 2)

Date & Document Version	Changes Made	Summary of Changes
March 2009 v9.0.0	Maintenance release.	—
November 2008 v8.1.0	Maintenance release.	—

Table 3-42. Document Revision History (Part 2 of 2)

Date & Document Version	Changes Made	Summary of Changes
May 2008 v8.0.0	Added text to describe the MMU, MPU, and advanced exceptions.	Added MMU, MPU, and advanced exceptions.
October 2007 v7.2.0	<ul style="list-style-type: none"> ■ Reworked text to refer to break and reset as exceptions. ■ Grouped exceptions, break, reset, and interrupts all under Exception Processing. ■ Added table showing all Nios II exceptions (by priority). ■ Removed “ctl” references to control registers. ■ Added <code>jmp i</code> instruction to tables. 	—
May 2007 v7.1.0	<ul style="list-style-type: none"> ■ Added table of contents to Introduction section. ■ Added Referenced Documents section. 	—
March 2007 v7.0.0	Maintenance release.	—
November 2006 v6.1.0	Maintenance release.	—
May 2006 v6.0.0	Maintenance release.	—
October 2005 v5.1.0	Maintenance release.	—
May 2005 v5.0.0	Maintenance release.	—
September 2004 v1.1	<ul style="list-style-type: none"> ■ Added details for new control register <code>ctl15</code>. ■ Updated details of debug and break processing to reflect new behavior of the <code>break</code> instruction. 	—
May 2004 v1.0	Initial release.	—

Introduction

This chapter describes the Nios® II Processor MegaWizard interface in SOPC Builder. This chapter contains the following sections:

- “Core Nios II Page” on page 4-1
- “Caches and Memory Interfaces Page” on page 4-5
- “Advanced Features Page” on page 4-8
- “JTAG Debug Module Page” on page 4-13
- “Custom Instructions Page” on page 4-16

The Nios II Processor MegaWizard interface allows you to specify the processor features for a particular Nios II hardware system. This chapter covers only the features of the Nios II processor that you can configure with the Nios II Processor MegaWizard interface. It is not a user guide for creating complete Nios II processor systems.

 To get started using SOPC Builder to design custom Nios II systems, refer to the *Nios II Hardware Development Tutorial*. Nios II development kits also provide a number of ready-made example hardware designs that demonstrate several different configurations of the Nios II processor.

The Nios II Processor MegaWizard interface has several pages. The following sections describe the settings available on each page.

 Due to evolution and improvement of the Nios II Processor MegaWizard interface, the figures in this chapter might not match the exact screens that appear in SOPC Builder.

Core Nios II Page

The **Core Nios II** page presents the main settings for configuring the Nios II processor. [Figure 4-1](#) shows an example of the **Core Nios II** page.

Figure 4-1. Core Nios II Page in the Nios II Processor MegaWizard

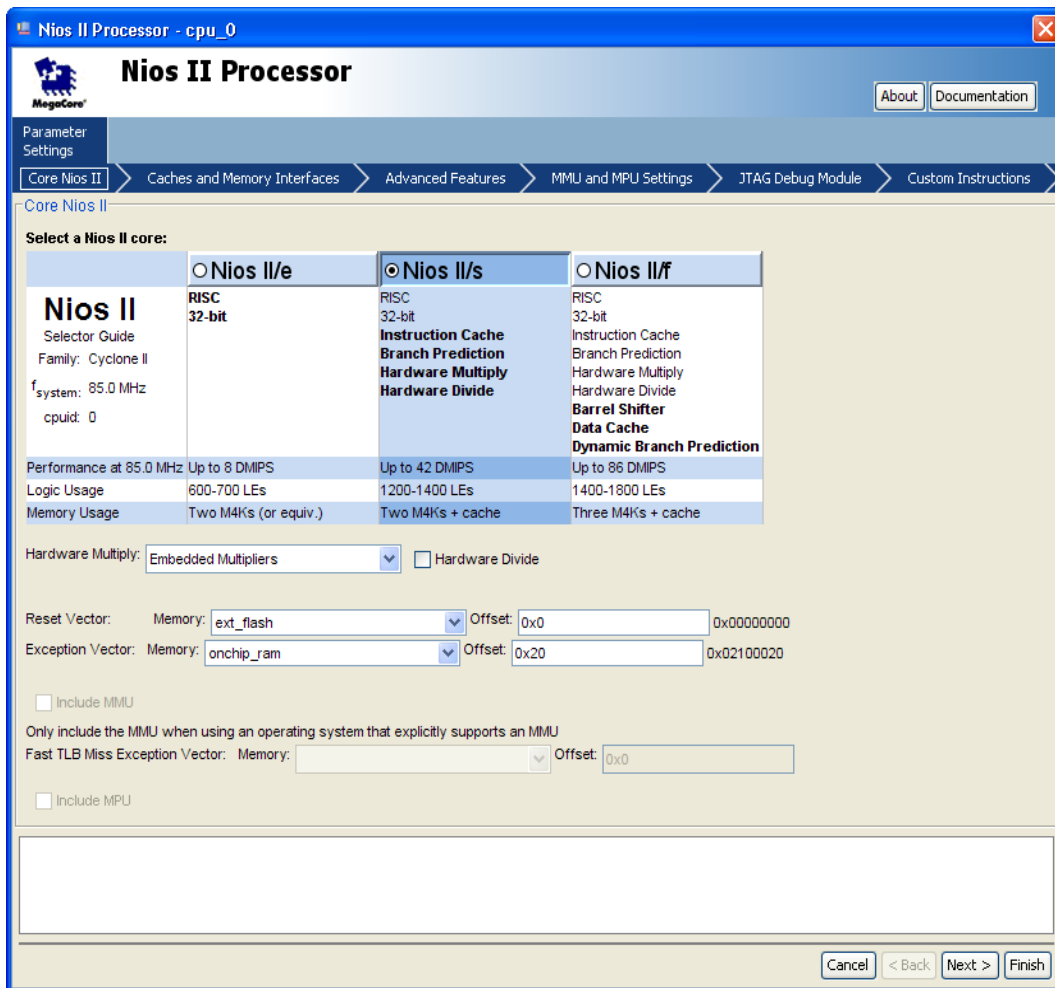

The following sections describe the configuration settings available.

Core Selection

The main purpose of the **Core Nios II** page is to select the processor core. The core you select on this page affects other options available on this and other pages.

Altera® offers the following Nios II cores:

- **Nios II/f**—The Nios II/f “fast” core is designed for fast performance. As a result, this core presents the most configuration options allowing you to fine-tune the processor for performance.
- **Nios II/s**—The Nios II/s “standard” core is designed for small size while maintaining performance.
- **Nios II/e**—The Nios II/e “economy” core is designed to achieve the smallest possible core size. As a result, this core has a limited feature set, and many settings are not available when the Nios II/e core is selected.

As shown in [Figure 4-1](#), the Core Nios II page displays a “selector guide” table that lists the basic properties of each core.

 For complete details of each core, refer to the [Nios II Core Implementation Details](#) chapter of the *Nios II Processor Reference Handbook*.

Multiply and Divide Settings

The Nios II/s and Nios II/f cores offer hardware multiply and divide options. You can choose the best option to balance embedded multiplier usage, logic element (LE) usage, and performance.

The **Hardware Multiply** setting for each core provides a subset of the options in the following list:

- **DSP Block**—Include DSP block multipliers in the arithmetic logic unit (ALU). This option is only present when targeting devices that have DSP block multipliers.
- **Embedded Multipliers**—Include embedded multipliers in the ALU. This option is only present when targeting FPGA devices that have embedded multipliers.
- **Logic Elements**—Include LE-based multipliers in the ALU. This option achieves high multiply performance without consuming embedded multiplier resources.
- **None**—This option conserves logic resources by eliminating multiply hardware. Multiply operations are implemented in software.

Turning on **Hardware Divide** includes LE-based divide hardware in the ALU. The **Hardware Divide** option achieves much greater performance than software emulation of divide operations.

 For details on the performance effects of the **Hardware Multiply** and **Hardware Divide** options, refer to the [Nios II Core Implementation Details](#) chapter of the *Nios II Processor Reference Handbook*.

Reset Vector

You can select the memory module where the reset code (boot loader) resides, and the location of the reset vector (reset address). The reset vector cannot be configured until your system memory components are in place.

The **Memory** list, which includes all memory modules mastered by the Nios II processor, allows you to select the reset vector memory module. In a typical system, you select a nonvolatile memory module for the reset code.

Offset allows you to specify the location of the reset vector relative to the memory module’s base address. SOPC Builder calculates the physical address of the reset vector when you modify the memory module, the offset, or the memory module’s base address, and displays the address next to the **Offset** box. This address, displayed next to the **Offset** box, is always a physical address, even when an MMU is present.

 For details on reset exceptions, refer to the [Programming Model](#) chapter of the *Nios II Processor Reference Handbook*.

General Exception Vector

You can select the memory module where the general exception vector (exception address) resides, and the location of the general exception vector. The general exception vector cannot be configured until your system memory components are in place.

The **Memory** list, which includes all memory modules mastered by the Nios II processor, allows you to select the exception vector memory module. In a typical system, you select a low-latency memory module for the exception code.

Offset allows you to specify the location of the exception vector relative to the memory module's base address. SOPC Builder calculates the physical address of the exception vector when you modify the memory module, the offset, or the memory module's base address. This address, displayed next to the **Offset** box, is always a physical address, even when an MMU is present.

For details on exceptions, refer to the *Programming Model* chapter of the *Nios II Processor Reference Handbook*.

Memory Management Unit Settings

The Nios II/f core offers a memory management unit (MMU) to support full-featured operating systems. Turning on **Include MMU** includes the Nios II MMU in your Nios II hardware system.



Do not include an MMU in your Nios II system unless your operating system requires it. The MMU is only useful with software that takes advantage of it. Many Nios II systems involve simpler system software, such as Altera® HAL or MicroC/OS-II. Such software is unlikely to function correctly with an MMU-based Nios II processor.

Fast TLB Miss Exception Vector

The fast TLB miss exception vector is a special exception vector used exclusively by the MMU to handle TLB miss exceptions. You can select the memory module where the fast TLB miss exception vector (exception address) resides, and the location of the fast TLB miss exception vector. The fast TLB miss exception vector cannot be configured until your system memory components are in place.

The **Memory** list, which includes all memory modules mastered by the Nios II processor, allows you to select the exception vector memory module. In a typical system, you select a low-latency memory module for the exception code.

Offset allows you to specify the location of the exception vector relative to the memory module's base address. SOPC Builder calculates the physical address of the exception vector when you modify the memory module, the offset, or the memory module's base address. This address, displayed next to the **Offset** box, is always a physical address.



The Nios II MMU is optional and mutually exclusive from the Nios II MPU. Nios II systems can include either an MMU or MPU, but cannot include both an MMU and MPU in the same design.





For details on the Nios II MMU, refer to the *Programming Model* chapter of the *Nios II Processor Reference Handbook*.

-  To function correctly with the MMU, the base physical address of all exception vectors (reset, general exception, break, and fast TLB miss) must point to low physical memory so that hardware can correctly map their virtual addresses into the kernel partition. This restriction is enforced by the Nios II Processor MegaWizard interface.

Memory Protection Unit Settings

The Nios II/f core offers a memory protection unit (MPU) to support operating systems and runtime environments that desire memory protection without the overhead of virtual memory management. Turning on **Include MPU** includes the Nios II MPU in your Nios II hardware system.

-  The Nios II MPU is optional and mutually exclusive from the Nios II MMU. Nios II systems can include either an MPU or MMU, but cannot include both an MPU and MMU in the same design.
-  For details on the Nios II MPU, refer to the *Programming Model* chapter of the *Nios II Processor Reference Handbook*.

Caches and Memory Interfaces Page

The **Caches and Memory Interfaces** page allows you to configure the cache and tightly-coupled memory usage for the instruction and data master ports. [Figure 4-2](#) shows an example of the **Caches and Memory Interfaces** page.

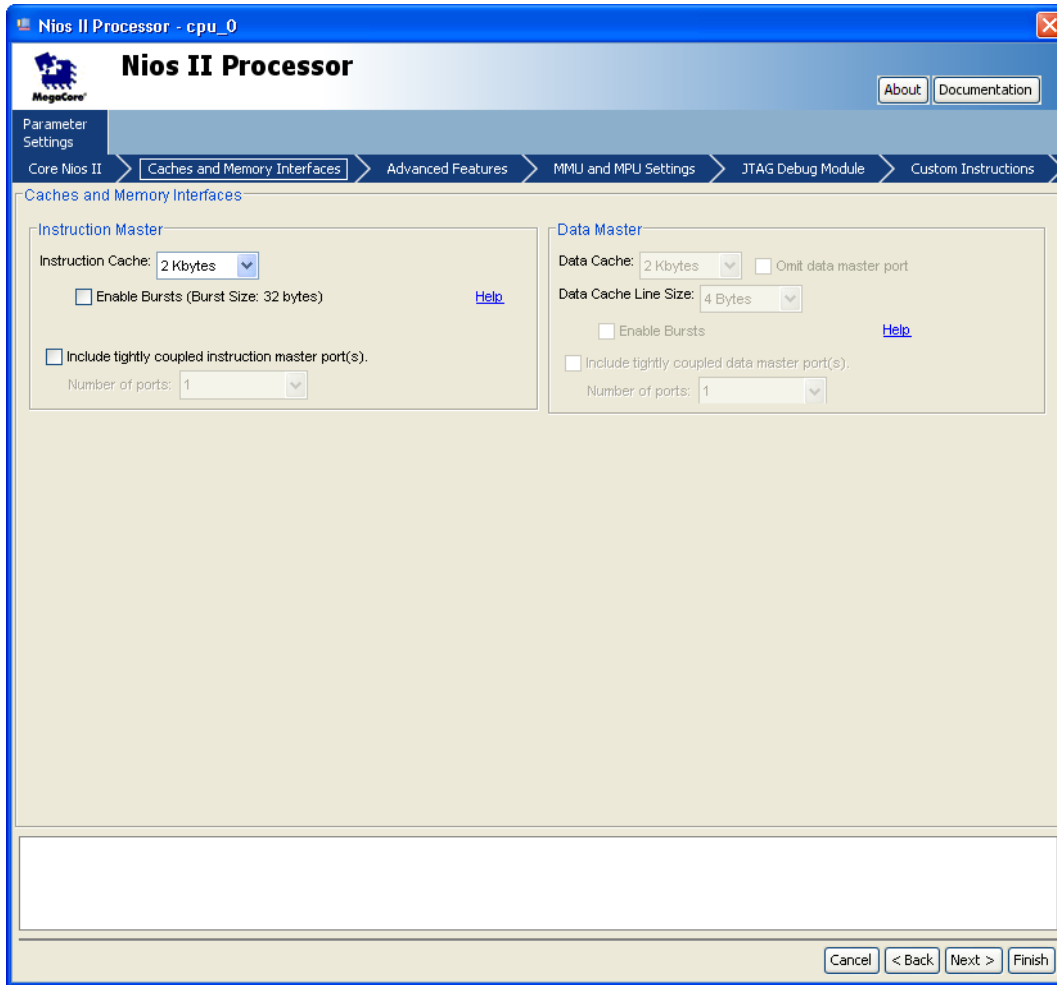
Figure 4-2. Caches and Memory Interfaces Page in the Nios II Processor MegaWizard

The following sections describe the configuration settings available.

Instruction Master Settings

The **Instruction Master** settings provide the following options for the Nios II/f and Nios II/s cores:

- **Instruction Cache**—Specifies the size of the instruction cache. Valid sizes are from 512 bytes to 64 KBytes, or None.

Choosing **None** disables the instruction cache, which also removes the Avalon-MM instruction master port from the Nios II processor. In this case, you must include a tightly-coupled instruction memory.

- **Enable Bursts**—The Nios II processor can fill its instruction cache lines using burst transfers. Usually you enable bursts on the processor's instruction master when instructions are stored in DRAM, and disable bursts when instructions are stored in SRAM.

Bursting to DRAM typically improves memory bandwidth, but might consume additional FPGA resources. Be aware that when bursts are enabled, accesses to slaves might go through additional hardware (called "burst adapters") which might decrease f_{MAX} .

When the Nios II processor transfers execution to the first word of a cache line, the processor fills the line by executing a sequence of word transfers that have ascending addresses, such as 0, 4, 8, 12, 16, 20, 24, 28.

However, when the Nios II processor transfers execution to an instruction that is not the first word of a cache line, the processor fetches the required (or "critical") instruction first, and then fills the rest of the cache line. The addresses of a burst increase until the last word of the cache line is filled, and then continue with the first word of the cache line. For example, with a 32-byte cache line, transferring control to address 8 results in a burst with the following address sequence: 8, 12, 16, 20, 24, 28, 0, 4.

- **Include tightly coupled instruction master port(s)**—When on, the Nios II processor includes tightly-coupled memory ports. You can specify one to four ports with the **Number of ports** setting. Tightly-coupled memory ports appear on the connection panel of the Nios II processor in the SOPC Builder **System Contents** tab. You must connect each port to exactly one memory component in the system.

Data Master Settings

The **Data Master** settings provide the following options for the Nios II/f core:

- **Data Cache**—Specifies the size of the data cache. Valid sizes are from **512 bytes** to **64 KBytes**, or **None**. Depending on the value specified for **Data Cache**, the following options are available:
 - **Data Cache Line Size**—Valid sizes are **4 bytes**, **16 bytes**, or **32 bytes**.
 - **Omit data master port**—If you set **Data Cache** to **None**, you can optionally turn on **Omit data master port** to remove the Avalon-MM data master port from the Nios II processor. In this case, you must include a tightly-coupled data memory.



Although the Nios II processor can operate entirely out of tightly-coupled memory without the need for Avalon-MM instruction or data masters, software debug is not possible when either the Avalon-MM instruction or data master is omitted.

Enable Bursts—The Nios II processor can fill its data cache lines using burst transfers. Usually you enable bursts on the processor's data bus when processor data is stored in DRAM, and disable bursts when processor data is stored in SRAM.

Bursting to DRAM typically improves memory bandwidth but might consume additional FPGA resources. Be aware that when bursts are enabled, accesses to slaves might go through additional hardware (called "burst adapters") which might decrease f_{MAX} .

Bursting is only enabled for data line sizes greater than 4 bytes. The burst length is 4 for a 16 byte line size and 8 for a 32 byte line size. Data cache bursts are always aligned on the cache line boundary. For example, with a 32-byte Nios II data cache line, a cache miss to the address 8 results in a burst with the following address sequence: 0, 4, 8, 12, 16, 20, 24 and 28.

- **Include tightly coupled data master port(s)**—When on, the Nios II processor includes tightly-coupled memory ports. You can specify one to four ports with the **Number of ports** setting. Tightly-coupled memory ports appear on the connection panel of the Nios II processor in the SOPC Builder **System Contents** tab. You must connect each port to exactly one memory component in the system.

Advanced Features Page

The **Advanced Features** page allows you to enable specialized features of the Nios II processor. [Figure 4-3](#) shows the **Advanced Features** page.

Figure 4-3. Advanced Features Page in the Nios II Processor MegaWizard

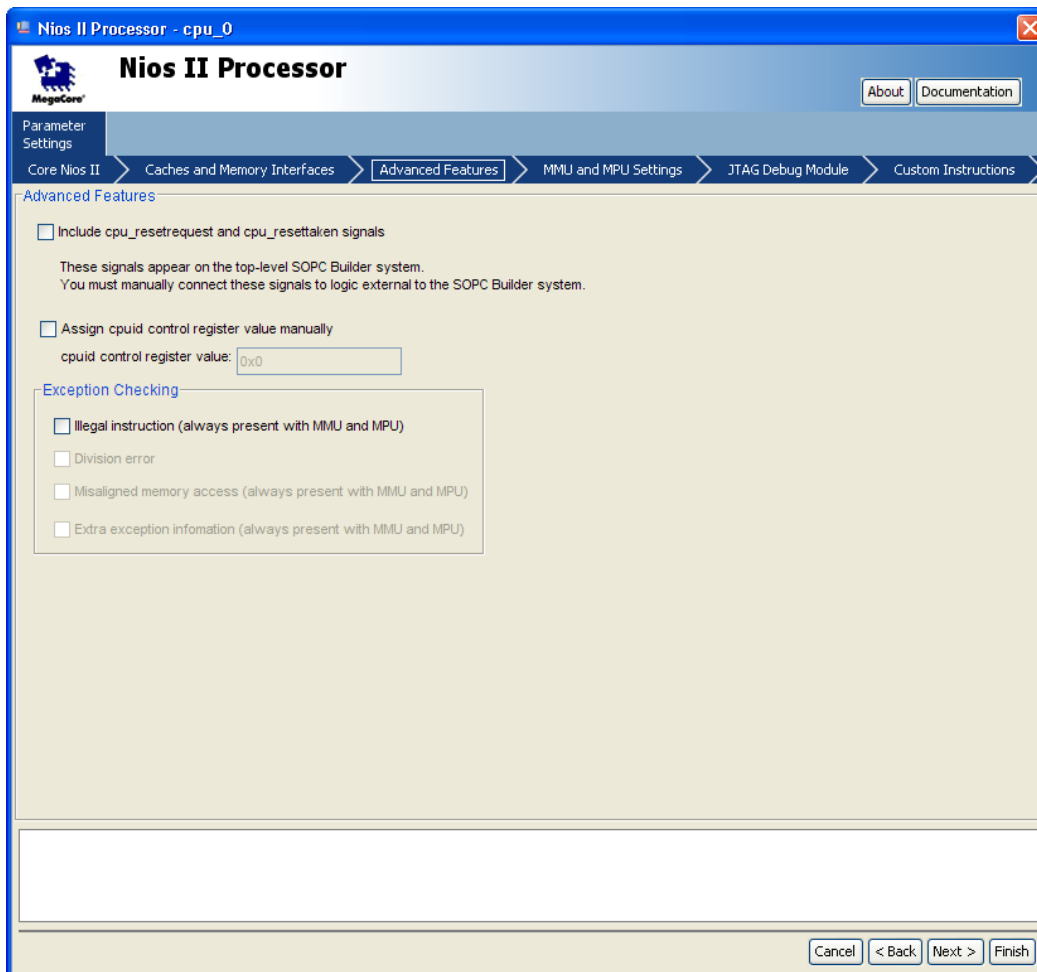

Reset Signals

The **Include `cpu_resetrequest` and `cpu_resettaken` signals** reset signals setting provides the following functionality. When on, the Nios II processor includes processor-only reset request signals. These signals let another device individually reset the Nios II processor without resetting the entire SOPC Builder system. The signals are exported to the top level of your SOPC Builder system.

 For further details on the reset signals, refer to the *Processor Architecture* chapter of the *Nios II Processor Reference Handbook*.

Control Registers

The **Assign `cpuid` control register value manually** control register setting provides the following functionality. When on, you can assign the `cpuid` control register value yourself. Normally, `cpuid` is automatically assigned in your SOPC Builder system. To assign the value yourself, type a 32-bit value (in hexadecimal or decimal format) into the **`cpuid` control register value** box.

Exception Checking

The **Exception Checking** settings provide the following options:

- **Illegal instruction**—When **Illegal instruction** is on, the processor generates an illegal instruction exception when an instruction with an undefined opcode or opcode-extension field is executed.



When your system contains an MMU or MPU, the processor automatically generates illegal instruction exceptions. Therefore, the **Illegal instruction** setting is always disabled when the **Core Nios II** page **Include MMU** or **Include MPU** are on.

- **Division error**—Division error detection is only available for the Nios II/f core, and only then when **Hardware Divide** on the **Core Nios II** page is on. When divide instructions are not supported by hardware, the **Division error** setting is disabled.

When **Division error** is on, the processor generates a division error exception when it detects divide instructions that produce a result that cannot be represented in the destination register. This only happens in the following two cases:

- Divide by zero
- Divide overflow—A signed division that divides the largest negative number -2147483648 (0x80000000) by -1 (0xffffffff).
- **Misaligned memory access**—Misaligned memory access detection is only available for the Nios II/f core. When **Misaligned memory access** is on, the processor checks for misaligned memory accesses.



When your system contains an MMU or MPU, the processor automatically generates misaligned memory access exceptions. Therefore, the **Misaligned memory access** checkbox is always disabled when **Include MMU** or **Include MPU** on the **Core Nios II** page are on.

There are two misaligned memory address exceptions:

- **Misaligned data address**—Data addresses of load and store instructions are checked for misalignment. A data address is considered misaligned if the byte address is not a multiple of the data width of the load or store instruction (4 bytes for word, 2 bytes for half-word). Byte load and store instructions are always aligned so never generate a misaligned data address exception.
- **Misaligned destination address**—Destination instruction addresses of `br`, `callr`, `jmp`, `ret`, `eret`, and `bret` instructions are checked for misalignment. A destination instruction address is considered misaligned if the target byte address of the instruction is not a multiple of four.
- **Extra exception information**—When **Extra exception information** is on, non-break exceptions store a code in the `CAUSE` field of the `exception control` register to indicate the cause of the exception.

 When your system contains an MMU or MPU, the processor automatically generates extra exception information. Therefore, the **Extra exception information** setting is always disabled when the **Core Nios II** page **Include MMU** or **Include MPU** are on.

Your exception handler can use this code to quickly determine the proper action to take, rather than have to determine the cause of an exception through instruction decoding. Additionally, some exceptions also store the instruction or data address associated with the exception in the `badaddr` register.

 For further descriptions of exceptions, exception handling, and control registers, refer to the *Programming Model* chapter of the *Nios II Processor Reference Handbook*.

MMU and MPU Settings Page

The **MMU and MPU Settings** page presents settings for configuring the MMU and MPU on the Nios II processor. You can select the features appropriate for your target application. [Figure 4-4](#) shows the **MMU and MPU Settings** page.

Figure 4-4. MMU and MPU Settings Page in the Nios II Processor MegaWizard

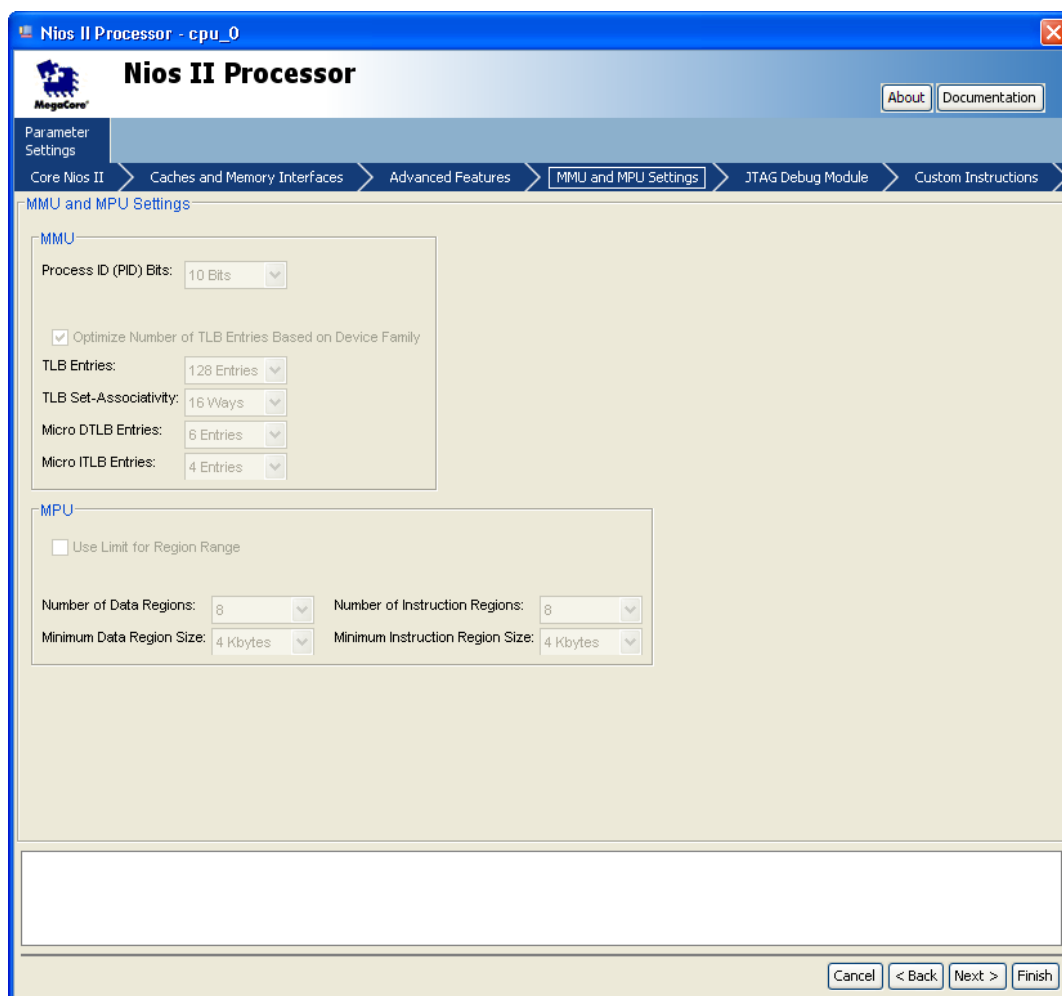

MMU

When **Include MMU** on the **Core Nios II** page is on, the **MMU and MPU Settings** page provide the following options for the MMU in the Nios II/f core. Typically, you should not need to change any of these settings from their default values.

- **Process ID (PID) Bits**—Specifies the number of bits to use to represent the process identifier.
- **Optimize number of TLB entries based on device family**—When on, specifies the optimal number of TLB entries to allocate based on the device family of the target hardware and disables **TLB Entries**.
- **TLB Entries**—Specifies the number of entries in the translation lookaside buffer (TLB).
- **TLB Set-Associativity**—Specifies the number of set-associativity ways in the TLB.
- **Micro ITLB Entries**—Specifies the number of entries in the micro instruction TLB.
- **Micro DTLB Entries**—Specifies the number of entries in the micro data TLB.

 For details on the MMU, refer to the *Programming Model* chapter of the *Nios II Processor Reference Handbook*. For specifics on the Nios II/f core, refer to the *Nios II Core Implementation Details* chapter of the *Nios II Processor Reference Handbook*.

MPU

When **Include MPU** on the **Core Nios II** page is on, the **MPU settings** on the **MMU and MPU Settings** page provide the following options for the MPU in the Nios II/f core.

- **Use Limit for Region Range**—Controls whether the amount of memory in the region is defined by size or upper address limit is defined by size or upper address limit. When on, the amount of memory is based on the given upper address limit. When off, the amount of memory is based on the given size.
- **Number of Data Regions**—Specifies the number of data regions to allocate. Allowed values range from 2 to 32.
- **Minimum Data Region Size**—Specifies the minimum data region size. Allowed values range from 64 bytes to 1 Mbyte and must be a power of two.
- **Number of Instruction Regions**—Specifies the number of instruction regions to allocate. Allowed values range from 2 to 32.
- **Minimum Instruction Region Size**—Specifies the minimum instruction region size. Allowed values range from 64 bytes to 1 Mbyte and must be a power of two.

 The maximum region size is the size of the Nios II instruction and data addresses automatically determined when the Nios II system is generated in SOPC Builder. Maximum region size is based on the address range of slaves connected to the Nios II instruction and data masters.

 For details on the MPU, refer to the *Programming Model* chapter of the *Nios II Processor Reference Handbook*. For specifics on the Nios II/f core, refer to the *Nios II Core Implementation Details* chapter of the *Nios II Processor Reference Handbook*.

JTAG Debug Module Page

The **JTAG Debug Module** page presents settings for configuring the JTAG debug module on the Nios II processor. You can select the debug features appropriate for your target application.

Soft-core processors such as the Nios II processor offer unique debug capabilities beyond the features of traditional fixed processors. The soft-core nature of the Nios II processor allows you to debug a system in development using a full-featured debug core, and later remove the debug features to conserve logic resources. For the release version of a product, you might choose to reduce the JTAG debug module functionality, or remove it altogether.

[Table 4-1](#) describes the debug features available to you for debugging your system.

Table 4-1. Debug Configuration Features

Feature	Description
JTAG Target Connection	Connects to the processor through the standard JTAG pins on the Altera FPGA. This provides the basic capabilities to start and stop the processor, and examine/edit registers and memory.
Download Software	Downloads executable code to the processor's memory via the JTAG connection.
Software Breakpoints	Sets a breakpoint on instructions residing in RAM.
Hardware Breakpoints	Sets a breakpoint on instructions residing in nonvolatile memory, such as flash memory.
Data Triggers	Triggers based on address value, data value, or read or write cycle. You can use a trigger to halt the processor on specific events or conditions, or to activate other events, such as starting execution trace, or sending a trigger signal to an external logic analyzer. Two data triggers can be combined to form a trigger that activates on a range of data or addresses.
Instruction Trace	Captures the sequence of instructions executing on the processor in real time.
Data Trace	Captures the addresses and data associated with read and write operations executed by the processor in real time.
On-Chip Trace	Stores trace data in on-chip memory.
Off-Chip Trace	Stores trace data in an external debug probe. Off-chip trace instantiates a PLL inside the Nios II core. Off-chip trace requires a debug probe from First Silicon Solutions (FS2) or Lauterbach GmbH.

The following sections describe the configuration settings available.

Debug Level Settings

There are five debug levels in the **JTAG Debug Module** page as shown in [Figure 4-5](#).

Figure 4-5. JTAG Debug Module Page in the Nios II Processor MegaWizard

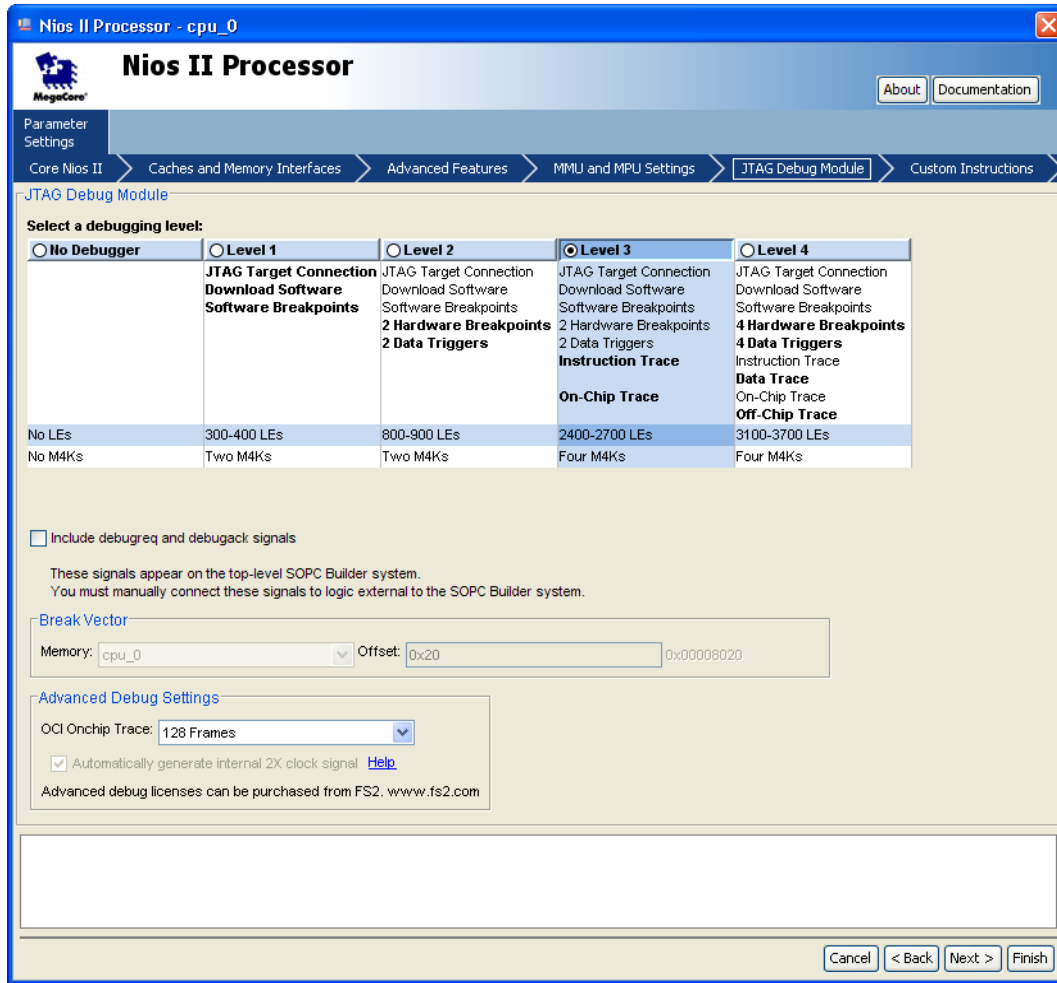

Table 4-2 on page 4-14 is a detailed list of the characteristics of each debug level. Different levels consume different amounts of on-chip resources. Certain Nios II cores have restricted debug options, and certain options require debug tools provided by First Silicon Solutions (FS2) or Lauterbach GmbH.

 For details on the debug features available, refer to the FS2 website (www.fs2.com) and the Lauterbach GmbH website (www.lauterbach.com).

Table 4-2. JTAG Debug Module Levels (Part 1 of 2)

Debug Feature	No Debug	Level 1	Level 2	Level 3	Level 4 (1)
Logic Usage	0	300 - 400 LEs	800 - 900 LEs	2,400 - 2,700 LEs	3,100 - 3,700 LEs
On-Chip Memory Usage	0	Two M4Ks	Two M4Ks	Four M4Ks	Four M4Ks
External I/O Pins Required (2)	0	0	0	0	20
JTAG Target Connection	No	Yes	Yes	Yes	Yes
Download Software	No	Yes	Yes	Yes	Yes

Table 4-2. JTAG Debug Module Levels (Part 2 of 2)

Debug Feature	No Debug	Level 1	Level 2	Level 3	Level 4 (1)
Software Breakpoints	None	Unlimited	Unlimited	Unlimited	Unlimited
Hardware Execution Breakpoints	0	None	2	2	4
Data Triggers	0	None	2	2	4
On-Chip Trace	0	None	None	Up to 64K Frames (3)	Up to 64K Frames
Off-Chip Trace (4)	0	None	None	None	128K Frames

Notes to Table 4-2:

- (1) Level 4 requires the purchase of a software upgrade from FS2 or Lauterbach.
- (2) Not including the dedicated JTAG pins on the Altera FPGA.
- (3) An additional license from FS2 is required to use more than 16 frames.
- (4) Off-chip trace requires the purchase of additional hardware from FS2 or Lauterbach.

Debug Signals

The **Include debugreq and debugack signals** debug signals setting provides the following functionality. When on, the Nios II processor includes debug request and acknowledge signals. These signals let another device temporarily suspend the Nios II processor for debug purposes. The signals are exported to the top level of your SOPC Builder system.

 For further details on the debug signals, refer to the *Processor Architecture* chapter of the *Nios II Processor Reference Handbook*.

Break Vector

If the Nios II processor contains a JTAG debug module, SOPC Builder determines a break vector (break address). **Memory** is always the processor core you are configuring. **Offset** is fixed at 0x20. SOPC Builder calculates the physical address of the break vector from the memory module's base address and the offset.

Advanced Debug Settings

Debug levels 3 and 4 support trace data collection into an on-chip memory buffer. You can set the on-chip trace buffer size to sizes from 128 to 64K trace frames, using **OCI Onchip Trace**. Larger buffer sizes consume more on-chip M4K RAM blocks. Every M4K RAM block can store up to 128 trace frames.

 The Nios II MMU does not support the JTAG debug module trace.

Debug level 4 also supports manual 2X clock signal specification. If you want to use a specific 2X clock signal in your FPGA design, turn off **Automatically generate internal 2X clock signal** and drive a 2X clock signal into your SOPC Builder system manually.

 For further details on trace frames, refer to the *Processor Architecture* chapter of the *Nios II Processor Reference Handbook*.

Custom Instructions Page

The **Custom Instructions** page allows you to connect custom instruction logic to the Nios II arithmetic logic unit (ALU). You can achieve significant performance improvements, often on the order of 10x to 100x, by implementing performance-critical operations in hardware using custom-instruction logic. [Figure 4-6](#) shows an example of the **Custom Instructions** page.

Figure 4-6. Custom Instructions Page in the Nios II Processor MegaWizard

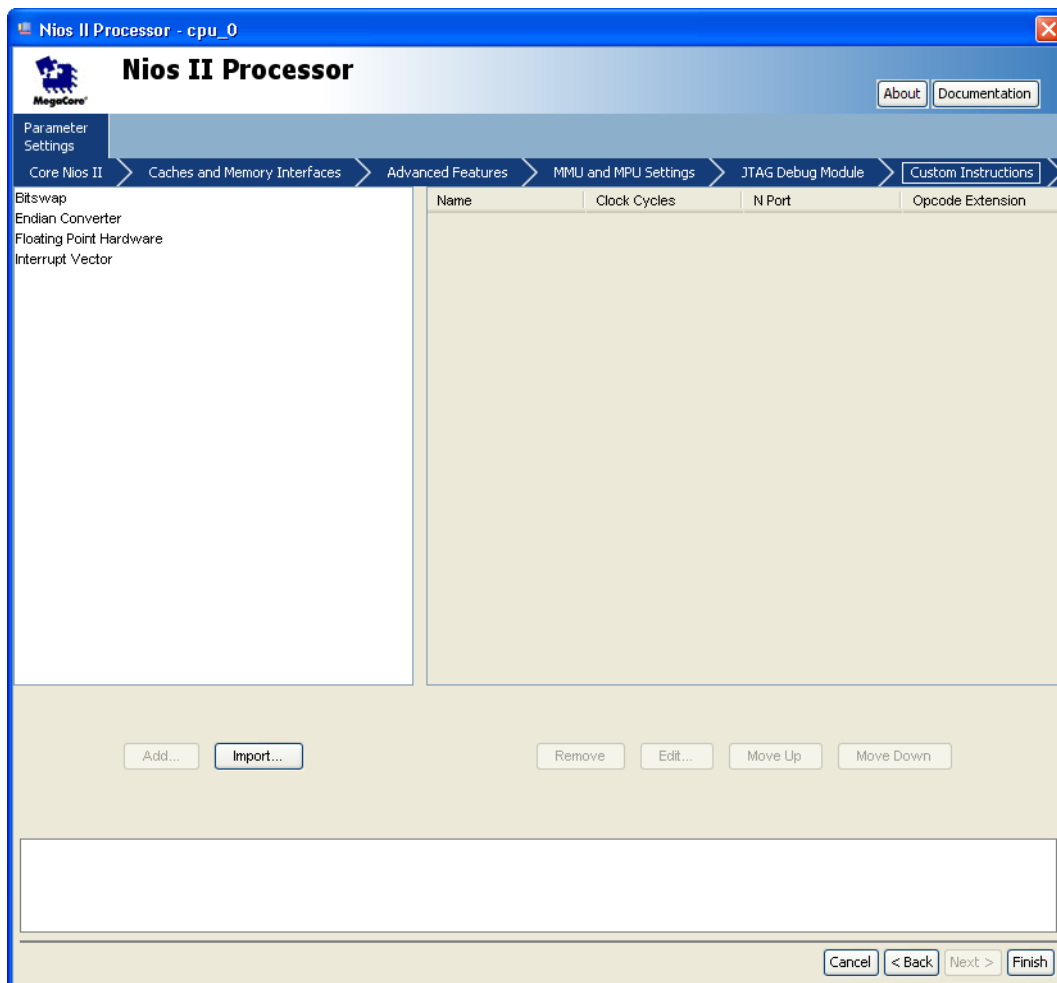



To add a custom instruction to the Nios II processor, select the custom instruction from the list at the left side of the page, and click **Add**. The added instruction appears on the right side of the page.



To display custom instructions in the table of active components on the SOPC Builder **System Contents** tab, click **Filter** in the lower-right of the **System Contents** tab, and turn on **Nios Custom Instruction**.

To create your own custom instruction using the component editor, click **Import**. After finishing in the component editor, the new instruction appears in the list at the left side of the **Custom Instructions** page.

 All signals in Nios II custom instructions must have the **Custom Instruction Slave** interface type. To guarantee the component editor automatically selects the **Custom Instruction Slave** interface type for your signals correctly during import, begin your signal names with an "ncs_" prefix. This prefix allows the component editor to determine the connection point type: a Nios II custom instruction slave. For example, if a custom instruction component has two data signals plus clock, reset, and result signals, an appropriate set of signal names is ncs_dataa, ncs_datab, ncs_clk, ncs_reset, and ncs_result.

 A complete discussion of the hardware and software design process for custom instructions is beyond the scope of this chapter. For full details on the topic of custom instructions, including working example designs, refer to the *Nios II Custom Instruction User Guide*.

The following sections describe the default custom instructions Altera provides.

Interrupt Vector Custom Instruction

The Nios II processor offers an interrupt vector custom instruction which reduces average and worst case interrupt latency.

To add the interrupt vector custom instruction to the Nios II processor, select **Interrupt Vector** from the list, and click **Add**.

There can only be one interrupt vector custom instruction component in a Nios II processor. If the interrupt vector custom instruction is present in the Nios II processor, the hardware abstraction layer (HAL) source detects it at compile time and generates code using the custom instruction.

The interrupt vector custom instruction improves both average and worst case interrupt latency by up to 20%. To achieve the lowest possible interrupt latency, consider using tightly-coupled memories so that interrupt handlers can run without cache misses.

 For details of the interrupt vector custom instruction implementation, refer to "Exception and Interrupt Controller" in the *Processor Architecture* chapter of the *Nios II Processor Reference Handbook*. For guidance with tightly-coupled memories, refer to "Tightly-Coupled Memory" in the *Processor Architecture* chapter of the *Nios II Processor Reference Handbook*.

Floating-Point Hardware Custom Instruction

The Nios II processor offers a set of optional predefined custom instructions that implement floating-point arithmetic operations. You can include these custom instructions to support computation-intensive floating-point applications.

The basic set of floating-point custom instructions includes single precision (32-bit) floating-point addition, subtraction, and multiplication. Floating-point division is available as an extension to the basic instruction set. The best choice for your hardware design depends on a balance among floating-point usage, hardware resource usage, and performance.

If the target device includes on-chip multiplier blocks, the floating-point custom instructions incorporate them as needed. If there are no on-chip multiplier blocks, the floating-point custom instructions are entirely based on general-purpose logic elements.

 The opcode extensions for the floating-point custom instructions are 252 through 255 (0xFC through 0xFF). These opcode extensions cannot be modified.

To add the floating-point custom instructions to the Nios II processor, select **Floating Point Hardware** from the list, and click **Add**. By default, SOPC Builder includes floating-point addition, subtraction, and multiplication, but omits the more resource intensive floating-point division. The **Floating Point Hardware** wizard, shown in [Figure 4-7](#), appears, giving you the option to include the floating-point division hardware.

Figure 4-7. Floating Point Hardware Wizard

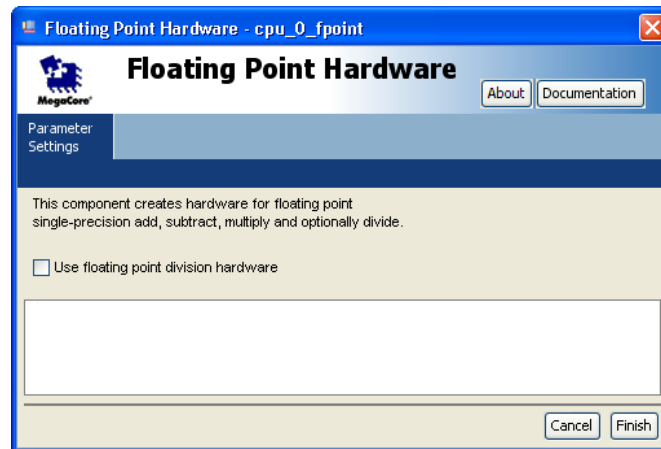

Turn on **Use floating point division hardware** to include floating-point division hardware. The floating-point division hardware requires more resources than the other instructions, so you might wish to omit it if your application does not make heavy use of floating-point division.

Click **Finish** to add the floating-point custom instructions to the Nios II processor.

 For further details on the floating-point custom instructions, refer to the [Processor Architecture](#) chapter of the *Nios II Processor Reference Handbook*.

Endian Converter Custom Instruction

The Nios II processor core offers an endian converter custom instruction to reduce the time spent performing byte reversal operations.

To add the endian converter custom instruction to the Nios II processor, select **Endian Converter** from the list, and click **Add**.

The endian converter custom instruction takes a 32 bit value and converts the endianness in a single clock cycle. The Nios II processor core supports little endian so this custom instruction allows you to convert data shared with a big endian processor core. It is important to note that this custom instruction does not convert the Nios II processor core to big endian architecture, it only converts big endian data to little endian and vice versa.

 For details about integrating the bitswap custom instruction into your own algorithm, refer to the *Nios II Custom Instruction User Guide*.

Bitswap Custom Instruction

The Nios II processor core offers a bitswap custom instruction to reduce the time spent performing bit reversal operations.

To add the bitswap custom instruction to the Nios II processor, select **Bitswap** from the list, and click **Add**.

The bitswap custom instruction reverses a 32 bit value in a single clock cycle. To perform the equivalent operation in software requires many mask and shift operations.

 For details about integrating the bitswap custom instruction into your own algorithm, refer to the *Nios II Custom Instruction User Guide*.

The Quartus II IP File

The Quartus II IP file (**.qip**) is a file generated by the MegaWizard interface or SOPC Builder that contains information about a generated IP core. You are prompted to add this **.qip** file to the current project at the time of Quartus II file generation. In most cases, the **.qip** file contains all of the necessary assignments and information required to process the core or system in the Quartus II compiler. Generally, a single **.qip** file is generated for each MegaCore function and for each SOPC Builder system. However, some more complex SOPC Builder components generate a separate **.qip** file, so the system **.qip** file references the component **.qip** file.

Referenced Documents

This chapter references the following documents:

- *Nios II Hardware Development Tutorial*
- *Nios II Core Implementation Details* chapter of the *Nios II Processor Reference Handbook*
- *Programming Model* chapter of the *Nios II Processor Reference Handbook*
- *Processor Architecture* chapter of the *Nios II Processor Reference Handbook*
- *Nios II Custom Instruction User Guide*

Document Revision History

Table 4-3 shows the revision history for this document.

Table 4-3. Document Revision History

Date & Document Version	Changes Made	Summary of Changes
March 2009 v9.0.0	Maintenance release.	—
November 2008 v8.1.0	<ul style="list-style-type: none"> ■ Added <code>debugreq</code> and <code>debugack</code> signal options to Advanced Features page. ■ Added <code>cpuid</code> manual override options to Advanced Features page. 	—
May 2008 v8.0.0	<ul style="list-style-type: none"> ■ Added MMU options to Nios II Core and Advanced Features pages. ■ Added exception handling options Advanced Features page. 	Added MMU and exception handling options.
October 2007 v7.2.0	Changed title to match other Altera documentation.	—
May 2007 v7.1.0	<ul style="list-style-type: none"> ■ Revised to reflect new MegaWizard interface. ■ Added “Endian Converter Custom Instruction” on page 4-18 and “Bitswap Custom Instruction” on page 4-19. ■ Added table of contents to Introduction section. ■ Added Referenced Documents section. 	—
March 2007 v7.0.0	Maintenance release.	—
November 2006 v6.1.0	<ul style="list-style-type: none"> ■ Add section on interrupt vector custom instruction. ■ Add section on system-dependent Nios II processor settings. 	—
May 2006 v6.0.0	<ul style="list-style-type: none"> ■ Added details on floating-point custom instructions. ■ Added section on Advanced Features tab. 	—
October 2005 v5.1.0	Maintenance release.	—
May 2005 v5.0.0	<ul style="list-style-type: none"> ■ Updates to reflect new GUI options in Nios II processor version 5.0. ■ New details in “Caches and Tightly-Coupled Memory” section. 	—
September 2004 v1.1	<ul style="list-style-type: none"> ■ Updates to reflect new GUI options in Nios II processor version 1.1. ■ New details in section “Multiply and Divide Settings.” 	—
May 2004 v1.0	Initial release.	—

This section provides additional information about the Nios® II processor.

This section includes the following chapters:

- [Chapter 5, Nios II Core Implementation Details](#)
- [Chapter 6, Nios II Processor Revision History](#)
- [Chapter 7, Application Binary Interface](#)
- [Chapter 8, Instruction Set Reference](#)

Introduction

This document describes all of the Nios® II processor core implementations available at the time of publishing. This document describes only implementation-specific features of each processor core. All cores support the Nios II instruction set architecture.

 For more information regarding the Nios II instruction set architecture, refer to the *Instruction Set Reference* chapter of the *Nios II Processor Reference Handbook*.

For common core information and details on a specific core, refer to the appropriate section:

- “Device Family Support” on page 5–3
- “Nios II/f Core” on page 5–3
- “Nios II/s Core” on page 5–12
- “Nios II/e Core” on page 5–18

Table 5–1 compares the objectives and features of each Nios II processor core. The table is designed to help system designers choose the core that best suits their target application.

Table 5–1. Nios II Processor Cores (Part 1 of 3)

Feature		Core		
		Nios II/e	Nios II/s	Nios II/f
Objective		Minimal core size	Small core size	Fast execution speed
Performance	DMIPS/MHz (1)	0.15	0.74	1.16
	Max. DMIPS (2)	31	127	218
	Max. f_{MAX} (2)	200 MHz	165 MHz	185 MHz
Area		< 700 LEs; < 350 ALMs	< 1400 LEs; < 700 ALMs	Without MMU or MPU: < 1800 LEs; < 900 ALMs With MMU: < 3000 LEs; < 1500 ALMs With MPU: < 2400 LEs; < 1200 ALMs
Pipeline		1 stage	5 stages	6 stages
External Address Space		2 GBytes	2 GBytes	2 GBytes without MMU 4 GBytes with MMU

Table 5-1. Nios II Processor Cores (Part 2 of 3)

Feature		Core		
		Nios II/e	Nios II/s	Nios II/f
Instruction Bus	Cache	–	512 bytes to 64 KBytes	512 bytes to 64 KBytes
	Pipelined Memory Access	–	Yes	Yes
	Branch Prediction	–	Static	Dynamic
	Tightly-Coupled Memory	–	Optional	Optional
Data Bus	Cache	–	–	512 bytes to 64 KBytes
	Pipelined Memory Access	–	–	–
	Cache Bypass Methods	–	–	<ul style="list-style-type: none"> ■ I/O instructions ■ Bit-31 cache bypass ■ Optional MMU
	Tightly-Coupled Memory	–	–	Optional
Arithmetic Logic Unit	Hardware Multiply	–	3-cycle (3)	1-cycle (3)
	Hardware Divide	–	Optional	Optional
	Shifter	1 cycle-per-bit	3-cycle shift (3)	1-cycle barrel shifter (3)
JTAG Debug Module	JTAG interface, run control, software breakpoints	Optional	Optional	Optional
	Hardware Breakpoints	–	Optional	Optional
	Off-Chip Trace Buffer	–	Optional	Optional
Memory Management Unit		–	–	Optional
Memory Protection Unit		–	–	Optional
Exception Handling	Exception Types	Software trap, unimplemented instruction, illegal instruction, hardware interrupt	Software trap, unimplemented instruction, illegal instruction, hardware interrupt	Software trap, unimplemented instruction, illegal instruction, supervisor-only instruction, supervisor-only instruction address, supervisor-only data address, misaligned destination address, misaligned data address, division error, fast TLB miss, double TLB miss, TLB permission violation, MPU region violation, hardware interrupt
	Integrated Interrupt Controller	Yes	Yes	Yes
User Mode Support		No; Permanently in supervisor mode	No; Permanently in supervisor mode	Yes; When MMU or MPU present

Table 5-1. Nios II Processor Cores (Part 3 of 3)

Feature	Core		
	Nios II/e	Nios II/s	Nios II/f
Custom Instruction Support	Yes	Yes	Yes

Notes to Table 5-1:

- (1) DMIPS performance for the Nios II/s and Nios II/f cores depends on the hardware multiply option.
- (2) Using the fastest hardware multiply option, and targeting a Stratix II FPGA in the fastest speed grade.
- (3) Multiply and shift performance depends on which hardware multiply option is used. If no hardware multiply option is used, multiply operations are emulated in software, and shift operations require one cycle per bit. For details, refer to the arithmetic logic unit description for each core.

Device Family Support

All Nios II cores provide the same support for target Altera device families. Nios II cores provide either full or preliminary device family support, as described below:

- Full support means the Nios II cores meet all functional and timing requirements for the device family and may be used in production designs
- Preliminary support means the Nios II cores meet all functional requirements, but might still be undergoing timing analysis for the device family; they may be used in production designs with caution.

Table 5-2 shows the level of support offered to each of the Altera device families by the Nios II cores.

Table 5-2. Device Family Support

Device Family	Support
Arria™ GX	Full
Stratix® IV	Preliminary
Stratix III	Full
Stratix II	Full
Stratix II GX	Full
Stratix GX	Full
Stratix	Full
Hardcopy® II	Full
HardCopy	Full
Cyclone® III	Full
Cyclone II	Full
Cyclone	Full
Other device families	No support

Nios II/f Core

The Nios II/f fast core is designed for high execution performance. Performance is gained at the expense of core size. The base Nios II/f core, without the memory management unit (MMU) or memory protection unit (MPU), is approximately 25% larger than the Nios II/s core. Altera designed the Nios II/f core with the following design goals in mind:

- Maximize the instructions-per-cycle execution efficiency
- Maximize f_{MAX} performance of the processor core

The resulting core is optimal for performance-critical applications, as well as for applications with large amounts of code and/or data, such as systems running a full-featured operating system.

Overview

The Nios II/f core:

- Has separate instruction and data caches
- Provides optional MMU to support operating systems that require an MMU
- Provides optional MPU to support operating systems and runtime environments that desire memory protection but do not need virtual memory management
- Can access up to 2 GBytes of external address space when no MMU is present and 4 GBytes when the MMU is present
- Supports optional tightly-coupled memory for instructions and data
- Employs a 6-stage pipeline to achieve maximum DMIPS/MHz
- Performs dynamic branch prediction
- Provides hardware multiply, divide, and shift options to improve arithmetic performance
- Supports the addition of custom instructions
- Supports the JTAG debug module
- Supports optional JTAG debug module enhancements, including hardware breakpoints and real-time trace

The following sections discuss the noteworthy details of the Nios II/f core implementation. This document does not discuss low-level design issues or implementation details that do not affect Nios II hardware or software designers.

Arithmetic Logic Unit

The Nios II/f core provides several arithmetic logic unit (ALU) options to improve the performance of multiply, divide, and shift operations.

Multiply and Divide Performance

The Nios II/f core provides the following hardware multiplier options:

- DSP Block—Includes DSP block multipliers available on the target device. This option is available only on Altera FPGAs that have DSP Blocks.
- Embedded Multipliers—Includes dedicated embedded multipliers available on the target device. This option is available only on Altera FPGAs that have embedded multipliers.
- Logic Elements—Includes hardware multipliers built from logic element (LE) resources.

- None—Does not include multiply hardware. In this case, multiply operations are emulated in software.

The Nios II/f core also provides a hardware divide option that includes LE-based divide circuitry in the ALU.

Including an ALU option improves the performance of one or more arithmetic instructions.

 The performance of the embedded multipliers differ, depending on the target FPGA family.

Table 5-3 lists the details of the hardware multiply and divide options.

Table 5-3. Hardware Multiply and Divide Details for the Nios II/f Core

ALU Option	Hardware Details	Cycles per Instruction	Result Latency Cycles	Supported Instructions
No hardware multiply or divide	Multiply and divide instructions generate an exception	–	–	None
Logic elements	ALU includes 32 x 4-bit multiplier	11	+2	mul, muli
DSP block on Stratix, Stratix II and Stratix III families	ALU includes 32 x 32-bit multiplier	1	+2	mul, muli, mulxss, mulxsu, mulxuu
Embedded multipliers on Cyclone II and Cyclone III families	ALU includes 32 x 16-bit multiplier	5	+2	mul, muli
Hardware divide	ALU includes multicycle divide circuit	4 – 66	+2	div, divu

The cycles per instruction value determines the maximum rate at which the ALU can dispatch instructions and produce each result. The latency value determines when the result becomes available. If there is no data dependency between the results and operands for back-to-back instructions, then the latency does not affect throughput. However, if an instruction depends on the result of an earlier instruction, then the processor stalls through any result latency cycles until the result is ready.

In the following code example, a multiply operation (with 1 instruction cycle and 2 result latency cycles) is followed immediately by an add operation that uses the result of the multiply. On the Nios II/f core, the `addi` instruction, like most ALU instructions, executes in a single cycle. However, in this code example, execution of the `addi` instruction is delayed by two additional cycles until the multiply operation completes.

```
mul r1, r2, r3      ; r1 = r2 * r3
addi r1, r1, 100    ; r1 = r1 + 100 (Depends on result of mul)
```

In contrast, the following code does not stall the processor.

```
mul r1, r2, r3      ; r1 = r2 * r3
or r5, r5, r6       ; No dependency on previous results
or r7, r7, r8       ; No dependency on previous results
addi r1, r1, 100    ; r1 = r1 + 100 (Depends on result of mul)
```

Shift and Rotate Performance

The performance of shift operations depends on the hardware multiply option. When a hardware multiplier is present, the ALU achieves shift and rotate operations in one or two clock cycles. Otherwise, the ALU includes dedicated shift circuitry that achieves one-bit-per-cycle shift and rotate performance. Refer to [Table 5-9](#) on [page 5-11](#) for details.

Memory Access

The Nios II/f core provides optional instruction and data caches. The cache size for each is user-definable, between 512 bytes and 64 KBytes.

The memory address width in the Nios II/f core depends on whether the optional MMU is present. Without an MMU, the Nios II/f core supports the bit-31 cache bypass method for accessing I/O on the data master port. Therefore addresses are 31 bits wide, reserving bit 31 for the cache bypass function. With an MMU, cache bypass is a function of the memory partition and the contents of the translation lookaside buffer (TLB). Therefore bit-31 cache bypass is disabled, and 32 address bits are available to address memory.

Instruction and Data Master Ports

The instruction master port is a pipelined Avalon® Memory-Mapped (Avalon-MM) master port. If the core includes data cache with a line size greater than four bytes, then the data master port is a pipelined Avalon-MM master port. Otherwise, the data master port is not pipelined.

The instruction and data master ports on the Nios II/f core are optional. A master port can be excluded, as long as the core includes at least one tightly-coupled memory to take the place of the missing master port.



Although the Nios II processor can operate entirely out of tightly-coupled memory without the need for Avalon-MM instruction or data masters, software debug is not possible when either the Avalon-MM instruction or data master is omitted.

Support for pipelined Avalon-MM transfers minimizes the impact of synchronous memory with pipeline latency. The pipelined instruction and data master ports can issue successive read requests before prior requests complete.

Instruction and Data Caches

This section first describes the similar characteristics of the instruction and data cache memories, and then describes the differences.

Both the instruction and data cache addresses are divided into fields based on whether or not an MMU is present in your system. [Table 5-4](#) shows the cache byte address fields for systems without an MMU present.

Table 5-4. Cache Byte Address Fields

31	30	29	28	27	26	25	24	23	22	21	20	19	18	17	16	15	14	13	12	11	10	9	8	7	6	5	4	3	2	1	0
tag													line											offset							

Table 5-5 shows the cache virtual byte address fields for systems with an MMU present. Table 5-6 shows the cache physical byte address fields for systems with an MMU present.

Table 5-5. Cache Virtual Byte Address Fields

31	30	29	28	27	26	25	24	23	22	21	20	19	18	17	16	15	14	13	12	11	10	9	8	7	6	5	4	3	2	1	0
												line												offset							

Table 5-6. Cache Physical Byte Address Fields

31	30	29	28	27	26	25	24	23	22	21	20	19	18	17	16	15	14	13	12	11	10	9	8	7	6	5	4	3	2	1	0
tag																											offset				

Instruction Cache

The instruction cache memory has the following characteristics:

- Direct-mapped cache implementation.
- 32 bytes (8 words) per cache line.
- The instruction master port reads an entire cache line at a time from memory, and issues one read per clock cycle.
- Critical word first.
- Virtually-indexed, physically-tagged, when MMU present.

The size of the tag field depends on the size of the cache memory and the physical address size. The size of the line field depends only on the size of the cache memory. The offset field is always five bits (i.e., a 32-byte line). The maximum instruction byte address size is 31 bits in systems without an MMU present. In systems with an MMU, the maximum instruction byte address size is 32 bits and the tag field always includes all the bits of the physical frame number (PFN).

The instruction cache is optional. However, excluding instruction cache from the Nios II/f core requires that the core include at least one tightly-coupled instruction memory.

Data Cache

The data cache memory has the following characteristics:

- Direct-mapped cache implementation
- Configurable line size of 4, 16, or 32 bytes
- The data master port reads an entire cache line at a time from memory, and issues one read per clock cycle.
- Write-back
- Write-allocate (i.e., on a store instruction, a cache miss allocates the line for that address)
- Virtually-indexed, physically-tagged, when MMU present

The size of the tag field depends on the size of the cache memory and the physical address size. The size of the line field depends only on the size of the cache memory. The size of the offset field depends on the line size. Line sizes of 4, 16, and 32 bytes have offset widths of 2, 4, and 5 bits respectively. The maximum data byte address size is 31 bits in systems without an MMU present. In systems with an MMU, the maximum data byte address size is 32 bits and the tag field always includes all the bits of the PFN.

The data cache is optional. If the data cache is excluded from the core, the data master port can also be excluded.

The Nios II instruction set provides several different instructions to clear the data cache. There are two important questions to answer when determining the instruction to use. Do you need to consider the tag field when looking for a cache match? Do you need to write dirty cache lines back to memory before clearing? [Table 5-8](#) shows the most appropriate instruction to use for each case.

Table 5-7. Data Cache Clearing Instructions

	Ignore Tag Field	Consider Tag Field
Write Dirty Lines	flushd	flushda
Don't Write Dirty Lines	initd	initda



The 4-byte line data cache implementation substitutes the `flushd` instruction for the `flushda` instruction and triggers an unimplemented instruction exception for the `initda` instruction. The 16-byte and 32-byte line data cache implementations fully support the `flushda` and `initda` instructions.



For more information regarding the Nios II instruction set, refer to the [Instruction Set Reference](#) chapter of the *Nios II Processor Reference Handbook*.

The Nios II/f core implements all the data cache bypass methods.



For information regarding the data cache bypass methods, refer to the [Processor Architecture](#) chapter of the *Nios II Processor Reference Handbook*.

Mixing cached and uncached accesses to the same cache line can result in invalid data reads. For example, the following sequence of events causes cache incoherency.

1. The Nios II core writes data to cache, creating a dirty data cache line.
2. The Nios II core reads data from the same address, but bypasses the cache.

Avoid mixing cached and uncached accesses to the same cache line. If it is necessary to mix cached and uncached data accesses, flush the corresponding line of the data cache after completing the cached accesses and before performing the uncached accesses.

Bursting

When the data cache is enabled, you can enable bursting on the data master port. Consult the documentation for memory devices connected to the data master port to determine whether bursting will improve performance.

Tightly-Coupled Memory

The Nios II/f core provides optional tightly-coupled memory interfaces for both instructions and data. A Nios II/f core can use up to four each of instruction and data tightly-coupled memories. When a tightly-coupled memory interface is enabled, the Nios II core includes an additional memory interface master port. Each tightly-coupled memory interface must connect directly to exactly one memory slave port.

When tightly-coupled memory is present, the Nios II core decodes addresses internally to determine if requested instructions or data reside in tightly-coupled memory. If the address resides in tightly-coupled memory, the Nios II core fetches the instruction or data through the tightly-coupled memory interface. Software accesses tightly-coupled memory with the usual load and store instructions, such as `ldw` or `ldwio`.

Accessing tightly-coupled memory bypasses cache memory. The processor core functions as if cache were not present for the address span of the tightly-coupled memory. Instructions for managing cache, such as `initd` and `flushd`, do not affect the tightly-coupled memory, even if the instruction specifies an address in tightly-coupled memory.

When the MMU is present, tightly-coupled memories are always mapped into the kernel partition and can only be accessed in supervisor mode.

Memory Management Unit

The Nios II/f core provides options to improve the performance of the Nios II MMU.



For details on the MMU architecture, refer to the *Programming Model* chapter of the *Nios II Processor Reference Handbook*.

Micro Translation Lookaside Buffers

The translation lookaside buffer (TLB) consists of one main TLB stored in on-chip RAM and two separate micro TLBs (μ TLB) for instructions (μ ITLB) and data (μ DTLB) stored in LE-based registers.

The μ TLBs have a configurable number of entries and are fully associative. The default configuration has 6 μ DTLB entries and 4 μ ITLB entries. The hardware chooses the least-recently used μ TLB entry when loading a new entry.

The μ TLBs are not visible to software. They act as an inclusive cache of the main TLB. The processor firsts look for a hit in the μ TLB. If it misses, it then looks for a hit in the main TLB. If the main TLB misses, the processor takes an exception. If the main TLB hits, the TLB entry is copied into the μ TLB for future accesses.

The hardware automatically flushes the μ TLB on each TLB write operation and on a `wrctl` to the `tlbmisc` register in case the process identifier (PID) has changed.

Memory Protection Unit

The Nios II/f core provides options to improve the performance of the Nios II MPU. For details on the MPU architecture, refer to the *Programming Model* chapter of the *Nios II Processor Reference Handbook*.

Execution Pipeline

This section provides an overview of the pipeline behavior for the benefit of performance-critical applications. Designers can use this information to minimize unnecessary processor stalling. Most application programmers never need to analyze the performance of individual instructions.

The Nios II/f core employs a 6-stage pipeline. The pipeline stages are listed in [Table 5-8](#).

Table 5-8. Implementation Pipeline Stages for Nios II/f Core

Stage Letter	Stage Name
F	Fetch
D	Decode
E	Execute
M	Memory
A	Align
W	Writeback

Up to one instruction is dispatched and/or retired per cycle. Instructions are dispatched and retired in-order. Dynamic branch prediction is implemented using a 2-bit branch history table. The pipeline stalls for the following conditions:

- Multi-cycle instructions
- Avalon-MM instruction master port read accesses
- Avalon-MM data master port read/write accesses
- Data dependencies on long latency instructions (e.g., load, multiply, shift).

Pipeline Stalls

The pipeline is set up so that if a stage stalls, no new values enter that stage or any earlier stages. No “catching up” of pipeline stages is allowed, even if a pipeline stage is empty.

Only the A-stage and D-stage are allowed to create stalls.

The A-stage stall occurs if any of the following conditions occurs:

- An A-stage memory instruction is waiting for Avalon-MM data master requests to complete. Typically this happens when a load or store misses in the data cache, or a `flushd` instruction needs to write back a dirty line.
- An A-stage shift/rotate instruction is still performing its operation. This only occurs with the multi-cycle shift circuitry (i.e., when the hardware multiplier is not available).
- An A-stage divide instruction is still performing its operation. This only occurs when the optional divide circuitry is available.
- An A-stage multi-cycle custom instruction is asserting its stall signal. This only occurs if the design includes multi-cycle custom instructions.

The D-stage stall occurs if an instruction is trying to use the result of a late result instruction too early and no M-stage pipeline flush is active. The late result instructions are loads, shifts, rotates, `rdctl`, multiplies (if hardware multiply is supported), divides (if hardware divide is supported), and multi-cycle custom instructions (if present).

Branch Prediction

The Nios II/f core performs dynamic branch prediction to minimize the cycle penalty associated with taken branches.

Instruction Performance

All instructions take one or more cycles to execute. Some instructions have other penalties associated with their execution. Late result instructions have two cycles placed between them and an instruction that uses their result. Instructions that flush the pipeline cause up to three instructions after them to be cancelled. This creates a three-cycle penalty and an execution time of four cycles. Instructions that require Avalon-MM transfers are stalled until any required Avalon-MM transfers (up to one write and one read) are completed.

Execution performance for all instructions is shown in [Table 5-9](#).

Table 5-9. Instruction Execution Performance for Nios II/f Core 4byte/line data cache (Part 1 of 2)

Instruction	Cycles	Penalties
Normal ALU instructions (e.g., <code>add</code> , <code>cmplt</code>)	1	
Combinatorial custom instructions	1	
Multi-cycle custom instructions	> 1	Late result
Branch (correctly predicted, taken)	2	
Branch (correctly predicted, not taken)	1	
Branch (mis-predicted)	4	Pipeline flush
<code>trap</code> , <code>break</code> , <code>eret</code> , <code>bret</code> , <code>flushp</code> , <code>wrctl</code> ; illegal and unimplemented instructions	4	Pipeline flush
<code>call</code> , <code>jmp</code>	2	
<code>jmp</code> , <code>ret</code> , <code>callr</code>	3	
<code>rdctl</code>	1	Late result
<code>load</code> (without Avalon-MM transfer)	1	Late result
<code>load</code> (with Avalon-MM transfer)	> 1	Late result
<code>store</code> (without Avalon-MM transfer)	1	
<code>store</code> (with Avalon-MM transfer)	> 1	
<code>flushd</code> , <code>flushda</code> (without Avalon-MM transfer)	2	
<code>flushd</code> , <code>flushda</code> (with Avalon-MM transfer)	> 2	
<code>initd</code> , <code>initda</code>	2	
<code>flushi</code> , <code>initi</code>	4	
Multiply	(1)	Late result
Divide	(1)	Late result
Shift/rotate (with hardware multiply using embedded multipliers)	1	Late result
Shift/rotate (with hardware multiply using LE-based multipliers)	2	Late result

Table 5-9. Instruction Execution Performance for Nios II/f Core 4byte/line data cache (Part 2 of 2)

Instruction	Cycles	Penalties
Shift/rotate (without hardware multiply present)	1 - 32	Late result
All other instructions	1	

Note to Table 5-9:

(1) Depends on the hardware multiply or divide option. Refer to Table 5-3 on page 5-5 for details.

Exception Handling

The Nios II/f core supports the following exception types:

- Hardware interrupt
- Software trap
- Illegal instruction
- Unimplemented instruction
- Supervisor-only instruction
- Supervisor-only instruction address
- Supervisor-only data address
- Misaligned data address
- Misaligned destination address
- Division error
- Fast TLB miss
- Double TLB miss
- TLB permission violation
- MPU region violation

JTAG Debug Module

The Nios II/f core supports the JTAG debug module to provide a JTAG interface to software debugging tools. The Nios II/f core supports an optional enhanced interface that allows real-time trace data to be routed out of the processor and stored in an external debug probe.



The Nios II MMU does not support the JTAG debug module trace.

Nios II/s Core

The Nios II/s standard core is designed for small core size. On-chip logic and memory resources are conserved at the expense of execution performance. The Nios II/s core uses approximately 20% less logic than the Nios II/f core, but execution performance also drops by roughly 40%. Altera designed the Nios II/s core with the following design goals in mind:

- Do not cripple performance for the sake of size.

- Remove hardware features that have the highest ratio of resource usage to performance impact.

The resulting core is optimal for cost-sensitive, medium-performance applications. This includes applications with large amounts of code and/or data, such as systems running an operating system in which performance is not the highest priority.

Overview

The Nios II/s core:

- Has an instruction cache, but no data cache
- Can access up to 2 Gbytes of external address space
- Supports optional tightly-coupled memory for instructions
- Employs a 5-stage pipeline
- Performs static branch prediction
- Provides hardware multiply, divide, and shift options to improve arithmetic performance
- Supports the addition of custom instructions
- Supports the JTAG debug module
- Supports optional JTAG debug module enhancements, including hardware breakpoints and real-time trace

The following sections discuss the noteworthy details of the Nios II/s core implementation. This document does not discuss low-level design issues or implementation details that do not affect Nios II hardware or software designers.

Arithmetic Logic Unit

The Nios II/s core provides several ALU options to improve the performance of multiply, divide, and shift operations.

Multiply and Divide Performance

The Nios II/s core provides the following hardware multiplier options:

- DSP Block—Includes DSP block multipliers available on the target device. This option is available only on Altera FPGAs that have DSP Blocks.
- Embedded Multipliers—Includes dedicated embedded multipliers available on the target device. This option is available only on Altera FPGAs that have embedded multipliers.
- Logic Elements—Includes hardware multipliers built from logic element (LE) resources.
- None—Does not include multiply hardware. In this case, multiply operations are emulated in software.

The Nios II/s core also provides a hardware divide option that includes LE-based divide circuitry in the ALU.

Including an ALU option improves the performance of one or more arithmetic instructions.



The performance of the embedded multipliers differ, depending on the target FPGA family.

Table 5-10 lists the details of the hardware multiply and divide options.

Table 5-10. Hardware Multiply and Divide Details for the Nios II/s Core

ALU Option	Hardware Details	Cycles per instruction	Supported Instructions
No hardware multiply or divide	Multiply and divide instructions generate an exception	–	None
LE-based multiplier	ALU includes 32 x 4-bit multiplier	11	mul, muli
Embedded multiplier on Stratix, Stratix II and Stratix III families	ALU includes 32 x 32-bit multiplier	3	mul, muli, mulxss, mulxsu, mulxuu
Embedded multiplier on Cyclone II and Cyclone III families	ALU includes 32 x 16-bit multiplier	5	mul, muli
Hardware divide	ALU includes multicycle divide circuit	4 – 66	div, divu

Shift and Rotate Performance

The performance of shift operations depends on the hardware multiply option. When a hardware multiplier is present, the ALU achieves shift and rotate operations in three or four clock cycles. Otherwise, the ALU includes dedicated shift circuitry that achieves one-bit-per-cycle shift and rotate performance. Refer to Table 5-13 on page 5-17 for details.

Memory Access

The Nios II/s core provides instruction cache, but no data cache. The instruction cache size is user-definable, between 512 bytes and 64 KBytes. The Nios II/s core can address up to 2 Gbyte of external memory. The Nios II architecture reserves the most-significant bit of data addresses for the bit-31 cache bypass method. In the Nios II/s core, bit 31 is always zero.



For information regarding data cache bypass methods, refer to the *Processor Architecture* chapter of the *Nios II Processor Reference Handbook*.

Instruction and Data Master Ports

The instruction port on the Nios II/s core is optional. The instruction master port can be excluded, as long as the core includes at least one tightly-coupled instruction memory. The instruction master port is a pipelined Avalon-MM master port.

Support for pipelined Avalon-MM transfers minimizes the impact of synchronous memory with pipeline latency. The pipelined instruction master port can issue successive read requests before prior requests complete.

The data master port on the Nios II/s core is always present.

Instruction Cache

The instruction cache for the Nios II/s core is nearly identical to the instruction cache in the Nios II/f core. The instruction cache memory has the following characteristics:

- Direct-mapped cache implementation
- The instruction master port reads an entire cache line at a time from memory, and issues one read per clock cycle.
- Critical word first

Table 5-11 shows the instruction byte address fields.

Table 5-11. Instruction Byte Address Fields

31	30	29	28	27	26	25	24	23	22	21	20	19	18	17	16	15	14	13	12	11	10	9	8	7	6	5	4	3	2	1	0
tag													line											offset							

The size of the tag field depends on the size of the cache memory and the physical address size. The size of the line field depends only on the size of the cache memory. The offset field is always five bits (i.e., a 32-byte line). The maximum instruction byte address size is 31 bits.

The instruction cache is optional. However, excluding instruction cache from the Nios II/s core requires that the core include at least one tightly-coupled instruction memory.

Tightly-Coupled Memory

The Nios II/s core provides optional tightly-coupled memory interfaces for instructions. A Nios II/s core can use up to four tightly-coupled instruction memories. When a tightly-coupled memory interface is enabled, the Nios II core includes an additional memory interface master port. Each tightly-coupled memory interface must connect directly to exactly one memory slave port.

When tightly-coupled memory is present, the Nios II core decodes addresses internally to determine if requested instructions reside in tightly-coupled memory. If the address resides in tightly-coupled memory, the Nios II core fetches the instruction through the tightly-coupled memory interface. Software does not require awareness of whether code resides in tightly-coupled memory or not.

Accessing tightly-coupled memory bypasses cache memory. The processor core functions as if cache were not present for the address span of the tightly-coupled memory. Instructions for managing cache, such as `init_i` and `flush_i`, do not affect the tightly-coupled memory, even if the instruction specifies an address in tightly-coupled memory.

Execution Pipeline

This section provides an overview of the pipeline behavior for the benefit of performance-critical applications. Designers can use this information to minimize unnecessary processor stalling. Most application programmers never need to analyze the performance of individual instructions, and live happy lives without ever studying Table 5-12.

The Nios II/s core employs a 5-stage pipeline. The pipeline stages are listed in Table 5-12.

Table 5-12. Implementation Pipeline Stages for Nios II/s Core

Stage Letter	Stage Name
F	Fetch
D	Decode
E	Execute
M	Memory
W	Writeback

Up to one instruction is dispatched and/or retired per cycle. Instructions are dispatched and retired in-order. Static branch prediction is implemented using the branch offset direction; a negative offset (backward branch) is predicted as taken, and a positive offset (forward branch) is predicted as not-taken. The pipeline stalls for the following conditions:

- Multi-cycle instructions (e.g., shift/rotate without hardware multiply)
- Avalon-MM instruction master port read accesses
- Avalon-MM data master port read/write accesses
- Data dependencies on long latency instructions (e.g., load, multiply, shift operations)

Pipeline Stalls

The pipeline is set up so that if a stage stalls, no new values enter that stage or any earlier stages. No “catching up” of pipeline stages is allowed, even if a pipeline stage is empty.

Only the M-stage is allowed to create stalls.

The M-stage stall occurs if any of the following conditions occurs:

- An M-stage load/store instruction is waiting for Avalon-MM data master transfer to complete.
- An M-stage shift/rotate instruction is still performing its operation when using the multi-cycle shift circuitry (i.e., when the hardware multiplier is not available).
- An M-stage shift/rotate/multiply instruction is still performing its operation when using the hardware multiplier (which takes three cycles).
- An M-stage multi-cycle custom instruction is asserting its stall signal. This only occurs if the design includes multi-cycle custom instructions.

Branch Prediction

The Nios II/s core performs static branch prediction to minimize the cycle penalty associated with taken branches.

Instruction Performance

All instructions take one or more cycles to execute. Some instructions have other penalties associated with their execution. Instructions that flush the pipeline cause up to three instructions after them to be cancelled. This creates a three-cycle penalty and an execution time of four cycles. Instructions that require an Avalon-MM transfer are stalled until the transfer completes.

Execution performance for all instructions is shown in [Table 5-13](#).

Table 5-13. Instruction Execution Performance for Nios II/s Core

Instruction	Cycles	Penalties
Normal ALU instructions (e.g., add, cmlt)	1	
Combinatorial custom instructions	1	
Multi-cycle custom instructions	> 1	
Branch (correctly predicted taken)	2	
Branch (correctly predicted not taken)	1	
Branch (mispredicted)	4	Pipeline flush
trap, break, eret, bret, flushp, wrctl, unimplemented	4	Pipeline flush
jmp, jmp_i, ret, call, callr	4	Pipeline flush
rdctl	1	
load, store	> 1	
flushi, initi	4	
Multiply	(1)	
Divide	(1)	
Shift/rotate (with hardware multiply using embedded multipliers)	3	
Shift/rotate (with hardware multiply using LE-based multipliers)	4	
Shift/rotate (without hardware multiply present)	1 to 32	
All other instructions	1	

Note to Table 5-13:

(1) Depends on the hardware multiply or divide option. Refer to [Table 5-10](#) on page 5-14 for details.

Exception Handling

The Nios II/s core supports the following exception types:

- Hardware interrupt
- Software trap
- Illegal instruction
- Unimplemented instruction

JTAG Debug Module

The Nios II/s core supports the JTAG debug module to provide a JTAG interface to software debugging tools. The Nios II/s core supports an optional enhanced interface that allows real-time trace data to be routed out of the processor and stored in an external debug probe.

Nios II/e Core

The Nios II/e economy core is designed to achieve the smallest possible core size. Altera designed the Nios II/e core with a singular design goal: reduce resource utilization any way possible, while still maintaining compatibility with the Nios II instruction set architecture. Hardware resources are conserved at the expense of execution performance. The Nios II/e core is roughly half the size of the Nios II/s core, but the execution performance is substantially lower.

The resulting core is optimal for cost-sensitive applications as well as applications that require simple control logic.

Overview

The Nios II/e core:

- Executes at most one instruction per six clock cycles
- Can access up to 2 Gbytes of external address space
- Supports the addition of custom instructions
- Supports the JTAG debug module
- Does not provide hardware support for potential unimplemented instructions
- Has no instruction cache or data cache
- Does not perform branch prediction

The following sections discuss the noteworthy details of the Nios II/e core implementation. This document does not discuss low-level design issues, or implementation details that do not affect Nios II hardware or software designers.

Arithmetic Logic Unit

The Nios II/e core does not provide hardware support for any of the potential unimplemented instructions. All unimplemented instructions are emulated in software.

The Nios II/e core employs dedicated shift circuitry to perform shift and rotate operations. The dedicated shift circuitry achieves one-bit-per-cycle shift and rotate operations.

Memory Access

The Nios II/e core does not provide instruction cache or data cache. All memory and peripheral accesses generate an Avalon-MM transfer. The Nios II/e core can address up to 2 Gbytes of external memory. The Nios II architecture reserves the most-significant bit of data addresses for the bit-31 cache bypass method. In the Nios II/e core, bit 31 is always zero.

 For information regarding data cache bypass methods, refer to the *Processor Architecture* chapter of the *Nios II Processor Reference Handbook*.

Instruction Execution Stages

This section provides an overview of the pipeline behavior as a means of estimating assembly execution time. Most application programmers never need to analyze the performance of individual instructions.

Instruction Performance

The Nios II/e core dispatches a single instruction at a time, and the processor waits for an instruction to complete before fetching and dispatching the next instruction. Because each instruction completes before the next instruction is dispatched, branch prediction is not necessary. This greatly simplifies the consideration of processor stalls. Maximum performance is one instruction per six clock cycles. To achieve six cycles, the Avalon-MM instruction master port must fetch an instruction in one clock cycle. A stall on the Avalon-MM instruction master port directly extends the execution time of the instruction.

Execution performance for all instructions is shown in [Table 5-14](#).

Table 5-14. Instruction Execution Performance for Nios II/e Core

Instruction	Cycles
Normal ALU instructions (e.g., add, cmlt)	6
branch, jmp, jmp, ret, call, callr	6
trap, break, eret, bret, flushp, wrctl, rdctl, unimplemented	6
load word	6 + Duration of Avalon-MM read transfer
load halfword	9 + Duration of Avalon-MM read transfer
load byte	10 + Duration of Avalon-MM read transfer
store	6 + Duration of Avalon-MM write transfer
Shift, rotate	7 to 38
All other instructions	6
Combinatorial custom instructions	6
Multi-cycle custom instructions	≥6

Exception Handling

The Nios II/e core supports the following exception types:

- Hardware interrupt
- Software trap
- Illegal instruction
- Unimplemented instruction

JTAG Debug Module

The Nios II/e core supports the JTAG debug module to provide a JTAG interface to software debugging tools. The JTAG debug module on the Nios II/e core does not support hardware breakpoints or trace.

Referenced Documents

This chapter references the following documents:

- *Instruction Set Reference* chapter of the *Nios II Processor Reference Handbook*
- *Processor Architecture* chapter of the *Nios II Processor Reference Handbook*
- *Programming Model* chapter of the *Nios II Processor Reference Handbook*

Document Revision History

Table 5-15 shows the revision history for this document.

Table 5-15. Document Revision History (Part 1 of 2)

Date & Document Version	Changes Made	Summary of Changes
March 2009 v9.0.0	Maintenance release.	—
November 2008 v8.1.0	Maintenance release.	—
May 2008 v8.0.0	Added text for MMU and MPU.	Added MMU and MPU
October 2007 v7.2.0	Added <code>jmp_i</code> instruction to tables.	—
May 2007 v7.1.0	<ul style="list-style-type: none"> ■ Added table of contents to Introduction section. ■ Added Referenced Documents section. 	—
March 2007 v7.0.0	Add preliminary Cyclone III device family support	Cyclone III device family
November 2006 v6.1.0	Add preliminary Stratix III device family support	Stratix III device family
May 2006 v6.0.0	Performance for <code>flushi</code> and <code>initi</code> instructions changes from 1 to 4 cycles for Nios II/s and Nios II/f cores.	—
October 2005 v5.1.0	Maintenance release.	—

Table 5-15. Document Revision History (Part 2 of 2)

Date & Document Version	Changes Made	Summary of Changes
May 2005 v5.0.0	Updates to Nios II/f and Nios II/s cores. Added tightly-coupled memory and new data cache options. Corrected cycle counts for shift/rotate operations.	—
December 2004 v1.2	Updates to Multiply and Divide Performance section for Nios II/f and Nios II/s cores.	—
September 2004 v1.1	Updates for Nios II 1.01 release.	—
May 2004 v1.0	Initial release.	—

Introduction

Each release of the Nios® II Embedded Design Suite (EDS) introduces improvements to the Nios II processor, the software development tools, or both. This document catalogs the history of revisions to the Nios II processor; it does not track revisions to development tools, such as the Nios II integrated development environment (IDE). This chapter contains the following sections:

- “Nios II Versions” on page 6-1
- “Architecture Revisions” on page 6-2
- “Core Revisions” on page 6-3
- “JTAG Debug Module Revisions” on page 6-6

Improvements to the Nios II processor might affect:

- Features of the Nios II architecture—An example of an architecture revision is adding instructions to support floating-point arithmetic.
- Implementation of a specific Nios II core—An example of a core revision is increasing the maximum possible size of the data cache memory for the Nios II/f core.
- Features of the JTAG debug module—An example of a JTAG debug module revision is adding an additional trigger input to the JTAG debug module, allowing it to halt processor execution on a new type of trigger event.

Altera implements Nios II revisions such that code written for an existing Nios II core also works on future revisions of the same core.

Nios II Versions

The number for any version of the Nios II processor is determined by the version of the Nios II EDS. For example, in the Nios II EDS version 8.0, all Nios II cores are also version 8.0.

Table 6-1 lists the version numbers of all releases of the Nios II processor.

Table 6-1. Nios II Processor Revision History (Part 1 of 2)

Version	Release Date	Notes
8.0	May 2008	<ul style="list-style-type: none"> ■ Added an optional memory management unit (MMU). ■ Added an optional memory protection unit (MPU). ■ Added advanced exception checking. ■ Added the <code>initda</code> instruction.
7.2	October 2007	Added the <code>jmp<i>i</i></code> instruction.
7.1	May 2007	No changes.
7.0	March 2007	No changes.

Table 6-1. Nios II Processor Revision History (Part 2 of 2)

Version	Release Date	Notes
6.1	November 2006	No changes.
6.0	May 2006	The name Nios II Development Kit describing the software development tools changed to Nios II Embedded Design Suite.
5.1 SP1	January 2006	Bug fix for Nios II/f core.
5.1	October 2005	No changes.
5.0	May 2005	<ul style="list-style-type: none"> ■ Changed version nomenclature. Altera® now aligns the Nios II processor version with Altera's Quartus II® software version. ■ Memory structure enhancements: <ol style="list-style-type: none"> (1) Added tightly-coupled memory. (2) Made data cache line size configurable. (3) Made cache optional in Nios II/f and Nios II/s cores. ■ Support for HardCopy® devices.
1.1	December 2004	<ul style="list-style-type: none"> ■ Minor enhancements to the architecture: Added <code>cpuid</code> control register, and updated the <code>break</code> instruction. ■ Increased user control of multiply and shift hardware in the arithmetic logic unit (ALU) for Nios II/s and Nios II/f cores. ■ Minor bug fixes.
1.01	September 2004	<ul style="list-style-type: none"> ■ Minor bug fixes.
1.0	May 2004	Initial release of the Nios II processor.

Architecture Revisions

Architecture revisions augment the fundamental capabilities of the Nios II architecture, and affect all Nios II cores. A change in the architecture mandates a revision to all Nios II cores to accommodate the new architectural enhancement. For example, when Altera adds a new instruction to the instruction set, Altera consequently must update all Nios II cores to recognize the new instruction. [Table 6-2](#) lists revisions to the Nios II architecture.

Table 6-2. Nios II Architecture Revisions (Part 1 of 2)

Version	Release Date	Notes
8.0	May 2008	<ul style="list-style-type: none"> ■ Added an optional MMU. ■ Added an optional MPU. ■ Added advanced exception checking to detect division errors, illegal instructions, misaligned memory accesses, and provide extra exception information. ■ Added the <code>initda</code> instruction.
7.2	October 2007	Added the <code>jmp</code> instruction.
7.1	May 2007	No changes.
7.0	March 2007	No changes.
6.1	November 2006	No changes.
6.0	May 2006	Added optional <code>cpu_resetrequest</code> and <code>cpu_resettaken</code> signals to all processor cores.

Table 6-2. Nios II Architecture Revisions (Part 2 of 2)

Version	Release Date	Notes
5.1	October 2005	No changes.
5.0	May 2005	Added the <code>flushda</code> instruction.
1.1	December 2004	<ul style="list-style-type: none"> ■ Added <code>cpuid</code> control register. ■ Updated <code>break</code> instruction specification to accept an immediate argument for use by debugging tools.
1.01	September 2004	No changes.
1.0	May 2004	Initial release of the Nios II processor architecture.

Core Revisions

Core revisions introduce changes to an existing Nios II core. Core revisions most commonly fix identified bugs, or add support for an architecture revision. Not every Nios II core is revised with every release of the Nios II architecture.

Nios II/f Core

Table 6-3 lists revisions to the Nios II/f core.

Table 6-3. Nios II/f Core Revisions (Part 1 of 2)

Version	Release Date	Notes
8.0	May 2008	<ul style="list-style-type: none"> ■ Implemented the optional MMU. ■ Implemented the optional MPU. ■ Implemented advanced exception checking. ■ Implemented the <code>initda</code> instruction.
7.2	October 2007	Implemented the <code>jmpfi</code> instruction.
7.1	May 2007	No changes.
7.0	March 2007	No changes.
6.1	November 2006	No changes.
6.0	May 2006	Cycle count for <code>flushi</code> and <code>initi</code> instructions changes from 1 to 4 cycles.
5.1 SP1	January 2006	<p>Bug Fix:</p> <p>Back-to-back store instructions can cause memory corruption to the stored data. If the first store is not to the last word of a cache line and the second store is to the last word of the line, memory corruption occurs.</p>
5.1	October 2005	No changes.

Table 6-3. Nios II/f Core Revisions (Part 2 of 2)

Version	Release Date	Notes
5.0	May 2005	<ul style="list-style-type: none"> ■ Added optional tightly-coupled memory ports. Designers can add zero to four tightly-coupled instruction master ports, and zero to four tightly-coupled data master ports. ■ Made the data cache line size configurable. Designers can configure the data cache with the following line sizes: 4, 16, or 32 bytes. Previously, the data cache line size was fixed at 4 bytes. ■ Made instruction and data caches optional (previously, cache memories were always present). If the instruction cache is not present, the Nios II core does not have an instruction master port, and must use a tightly-coupled instruction memory. ■ Full support for HardCopy devices (previous versions required a work around to support HardCopy devices).
1.1	December 2004	<ul style="list-style-type: none"> ■ Added user-configurable options affecting multiply and shift operations. Now designers can choose one of three options: <ol style="list-style-type: none"> (1) Use embedded multiplier resources available in the target device family (previously available). (2) Use logic elements to implement multiply and shift hardware (new option). (3) Omit multiply hardware. Shift operations take one cycle per bit shifted; multiply operations are emulated in software (new option). ■ Added <code>cpuid</code> control register. ■ Bug Fix: Interrupts that were disabled by <code>wrctl ienable</code> remained enabled for one clock cycle following the <code>wrctl</code> instruction. Now the instruction following such a <code>wrctl</code> cannot be interrupted.
1.01	September 2004	<ul style="list-style-type: none"> ■ Bug Fixes: <ol style="list-style-type: none"> (1) When a store to memory is followed immediately in the pipeline by a load from the same memory location, and the memory location is held in the data cache, the load may return invalid data. This situation can occur in C code compiled with optimization off (-O0). (2) The SOPC Builder top-level system module included an extra, unnecessary output port for systems with very small address spaces.
1.0	May 2004	Initial release of the Nios II/f core.

Nios II/s Core

Table 6-4 lists revisions to the Nios II/s core.

Table 6-4. Nios II/s Core Revisions (Part 1 of 2)

Version	Release Date	Notes
8.0	May 2008	Implemented the illegal instruction exception.
7.2	October 2007	Implemented the <code>jmp</code> instruction.
7.1	May 2007	No changes.
7.0	March 2007	No changes.
6.1	November 2006	No changes.
6.0	May 2006	Cycle count for <code>flushi</code> and <code>initi</code> instructions changes from 1 to 4 cycles.

Table 6-4. Nios II/s Core Revisions (Part 2 of 2)

Version	Release Date	Notes
5.1	October 2005	No changes.
5.0	May 2005	<ul style="list-style-type: none"> ■ Added optional tightly-coupled memory ports. Designers can add zero to four tightly-coupled instruction master ports. ■ Made instruction cache optional (previously instruction cache was always present). If the instruction cache is not present, the Nios II core does not have an instruction master port, and must use a tightly-coupled instruction memory. ■ Full support for HardCopy devices (previous versions required a work around to support HardCopy devices).
1.1	December 2004	<ul style="list-style-type: none"> ■ Added user-configurable options affecting multiply and shift operations. Now designers can choose one of three options: <ol style="list-style-type: none"> (1) Use embedded multiplier resources available in the target device family (previously available). (2) Use logic elements to implement multiply and shift hardware (new option). (3) Omit multiply hardware. Shift operations take one cycle per bit shifted; multiply operations are emulated in software (new option). ■ Added user-configurable option to include divide hardware in the ALU. Previously this option was available for only the Nios II/f core. ■ Added <code>cpuid</code> control register.
1.01	September 2004	<p>Bug fix:</p> <p>The SOPC Builder top-level system module included an extra, unnecessary output port for systems with very small address spaces.</p>
1.0	May 2004	Initial release of the Nios II/s core.

Nios II/e Core

Table 6-5 lists revisions to the Nios II/e core.

Table 6-5. Nios II/e Core Revisions

Version	Release Date	Notes
8.0	May 2008	Implemented the illegal instruction exception.
7.2	October 2007	Implemented the <code>jmp i</code> instruction.
7.1	May 2007	No changes.
7.0	March 2007	No changes.
6.1	November 2006	No changes.
6.0	May 2006	No changes.
5.1	October 2005	No changes.
5.0	May 2005	Full support for HardCopy devices (previous versions required a work around to support HardCopy devices).
1.1	December 2004	Added <code>cpuid</code> control register.
1.01	September 2004	<p>Bug fix:</p> <p>The SOPC Builder top-level system module included an extra, unnecessary output port for systems with very small address spaces.</p>
1.0	May 2004	Initial release of the Nios II/e core.

JTAG Debug Module Revisions

JTAG debug module revisions augment the debug capabilities of the Nios II processor, or fix bugs isolated within the JTAG debug module logic.

Table 6–6 lists revisions to the JTAG debug module.

Table 6–6. JTAG Debug Module Revisions

Version	Release Date	Notes
8.0	May 2008	No changes.
7.2	October 2007	No changes.
7.1	May 2007	No changes.
7.0	March 2007	No changes.
6.1	November 2006	No changes.
6.0	May 2006	No changes.
5.1	October 2005	No changes.
5.0	May 2005	Full support for HardCopy devices (previous versions of the JTAG debug module did not support HardCopy devices).
1.1	December 2004	Bug fix: When using the Nios II/s and Nios II/f cores, hardware breakpoints may have falsely triggered when placed on the instruction sequentially following a <code>jmp</code> , <code>trap</code> , or any branch instruction.
1.01	September 2004	<ul style="list-style-type: none"> ■ Feature enhancements: <ol style="list-style-type: none"> (1) Added the ability to trigger based on the instruction address. Uses include triggering trace control (trace on/off), sequential triggers, and trigger in/out signal generation. (2) Enhanced trace collection such that collection can be stopped when the trace buffer is full without halting the Nios II processor. (3) Armed triggers – Enhanced trigger logic to support two levels of triggers, or "armed triggers"; enabling the use of "Event A then event B" trigger definitions. ■ Bug fixes: <ol style="list-style-type: none"> (1) On the Nios II/s core, trace data sometimes recorded incorrect addresses during interrupt processing. (2) Under certain circumstances, captured trace data appeared to start earlier or later than the desired trigger location. (3) During debugging, the processor would hang if a hardware breakpoint and an interrupt occurred simultaneously.
1.0	May 2004	Initial release of the JTAG debug module.

Referenced Documents

This chapter references no other documents.

Document Revision History

Table 6–7 shows the revision history for this document.

Table 6-7. Document Revision History

Date & Document Version	Changes Made	Summary of Changes
March 2009 v9.0.0	Maintenance release.	—
November 2008 v8.1.0	Maintenance release.	—
May 2008 v8.0.0	<ul style="list-style-type: none"> ■ Added MMU information. ■ Added MPU information. ■ Added advanced exception checking information. ■ Added <code>initda</code> instruction information. 	Added MMU, MPU, advanced exception checking, and <code>initda</code> instruction.
October 2007 v7.2.0	<ul style="list-style-type: none"> ■ Added <code>jmp_i</code> instruction information. ■ Added exception handling information. 	Added <code>jmp_i</code> instruction
May 2007 v7.1.0	<ul style="list-style-type: none"> ■ Updated tables to reflect no changes to cores. ■ Added table of contents to Introduction section. ■ Added Referenced Documents section. 	—
March 2007 v7.0.0	Updated tables to reflect no changes to cores.	—
November 2006 v6.1.0	Updated tables to reflect no changes to cores.	—
May 2006 v6.0.0	Updates for Nios II cores version 6.0.	—
October 2005 v5.1.0	Updates for Nios II cores version 5.1.	—
May 2005 v5.0.0	Updates for Nios II cores version 5.0.	—
December 2004 v1.1	Updates for Nios II cores version 1.1.	—
September 2004 v1.0	Initial release.	—

This chapter describes the Application Binary Interface (ABI) for the Nios® II processor. The ABI describes:

- How data is arranged in memory
- Behavior and structure of the stack
- Function calling conventions

This chapter contains the following sections:

- “Data Types” on page 7-1
- “Memory Alignment” on page 7-1
- “Register Usage” on page 7-2
- “Stacks” on page 7-3
- “Arguments and Return Values” on page 7-6
- “Relocation” on page 7-8

Data Types

Table 7-1 shows the size and representation of the C/C++ data types for the Nios II processor.

Table 7-1. Representation of Data Types

Type	Size (Bytes)	Representation
char, signed char	1	two's complement (ASCII)
unsigned char	1	binary (ASCII)
short, signed short	2	two's complement
unsigned short	2	binary
int, signed int	4	two's complement
unsigned int	4	binary
long, signed long	4	two's complement
unsigned long	4	binary
float	4	IEEE
double	8	IEEE
pointer	4	binary
long long	8	two's complement
unsigned long long	8	binary

Memory Alignment

Contents in memory are aligned as follows:

- A function must be aligned to a minimum of 32-bit boundary.
- The minimum alignment of a data element is its natural size. A data element larger than 32 bits need only be aligned to a 32-bit boundary.
- Structures, unions, and strings must be aligned to a minimum of 32 bits.
- Bit fields inside structures are always 32-bit aligned.

Register Usage

The ABI adds additional usage conventions to the Nios II register file defined in the *Programming Model* chapter of the *Nios II Processor Reference Handbook*. The ABI uses the registers as shown in [Table 7-2](#).

Table 7-2. Nios II ABI Register Usage (Part 1 of 2)

Register	Name	Used by Compiler	Callee Saved (1)	Normal Usage
r0	zero	✓		0x00000000
r1	at			Assembler temporary
r2		✓		Return value (least-significant 32 bits)
r3		✓		Return value (most-significant 32 bits)
r4		✓		Register arguments (first 32 bits)
r5		✓		Register arguments (second 32 bits)
r6		✓		Register arguments (third 32 bits)
r7		✓		Register arguments (fourth 32 bits)
r8		✓		Caller-saved general-purpose registers
r9		✓		
r10		✓		
r11		✓		
r12		✓		
r13		✓		
r14		✓		
r15		✓		
r16		✓	✓	Callee-saved general-purpose registers
r17		✓	✓	
r18		✓	✓	
r19		✓	✓	
r20		✓	✓	
r21		✓	✓	
r22		✓	✓	
r23		✓	✓	
r24	et			Exception temporary
r25	bt			Break temporary
r26	gp	✓		Global pointer
r27	sp	✓		Stack pointer

Table 7-2. Nios II ABI Register Usage (Part 2 of 2)

Register	Name	Used by Compiler	Callee Saved (1)	Normal Usage
r28	fp	✓		Frame pointer (2)
r29	ea			Exception return address
r30	ba			Break return address
r31	ra	✓		Return address

Notes to Table 7-2:

- (1) A function can use one of these registers if it saves it first. The function must restore the register's original value before exiting.
- (2) If the frame pointer is not used, the register is available as a temporary register. Refer to "Frame Pointer Elimination" on page 7-4.

The endianness of values greater than 8 bits is little endian. The upper 8 bits of a value are stored at the higher byte address.

Stacks

The stack grows downward (i.e. towards lower addresses). The stack pointer points to the last used slot. The frame pointer points to the saved frame pointer near the top of the stack frame.

Figure 7-1 shows an example of the structure of a current frame. In this case, function a () calls function b (), and the stack is shown before the call and after the prologue in the called function has completed.

Figure 7-1. Stack Pointer, Frame Pointer and the Current Frame

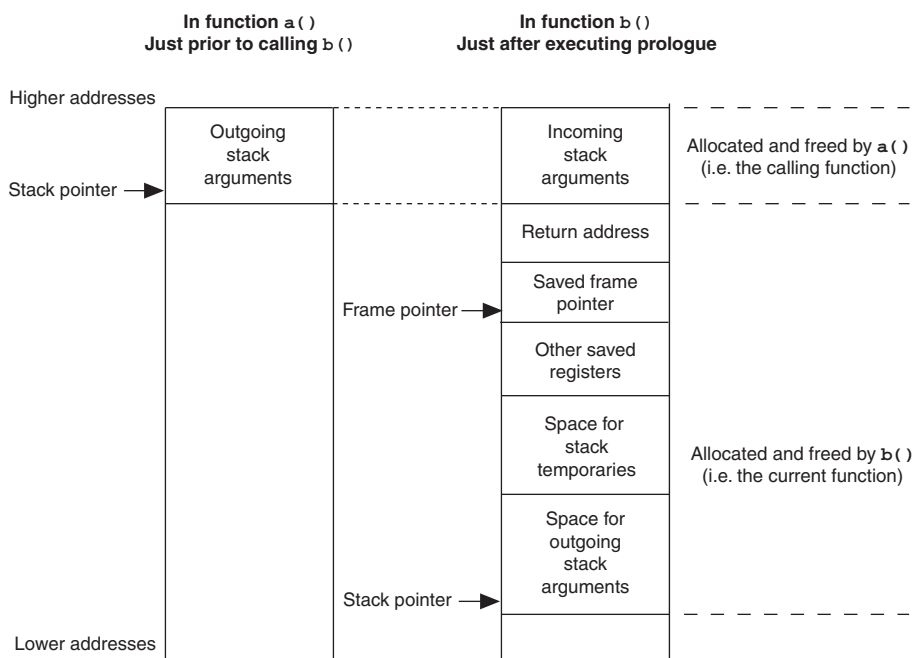

Each section of the current frame is aligned to a 32-bit boundary. The ABI requires the stack pointer be 32-bit aligned at all times.

Frame Pointer Elimination

The frame pointer is provided for debugger support. If you are not using a debugger, you can optimize your code by eliminating the frame pointer, using the `-fomit-frame-pointer` compiler option. When the frame pointer is eliminated, register `fp` is available as a temporary register.

Call Saved Registers

The compiler is responsible for saving registers that need to be saved in a function. If there are any such registers, they are saved on the stack, from high to low addresses, in the following order: `ra`, `fp`, `r2`, `r3`, `r4`, `r5`, `r6`, `r7`, `r8`, `r9`, `r10`, `r11`, `r12`, `r13`, `r14`, `r15`, `r16`, `r17`, `r18`, `r19`, `r20`, `r21`, `r22`, `r23`, `r24`, `r25`, `gp`, and `sp`. Stack space is not allocated for registers that are not saved.

Further Examples of Stacks

There are a number of special cases for stack layout, which are described in this section.

Stack Frame for a Function With `alloca()`

The Nios II stack frame implementation provides support for the `alloca()` function, defined in the Berkeley Software Distribution (BSD) extension to C, and implemented by the gcc compiler. Figure 7-2 depicts what the frame looks like after `alloca()` is called. The space allocated by `alloca()` replaces the outgoing arguments and the outgoing arguments get new space allocated at the bottom of the frame.



The Nios II C/C++ compiler maintains a frame pointer for any function that calls `alloca()`, even if `-fomit-frame-pointer` is specified.

Figure 7-2. Stack Frame after Calling `alloca()`

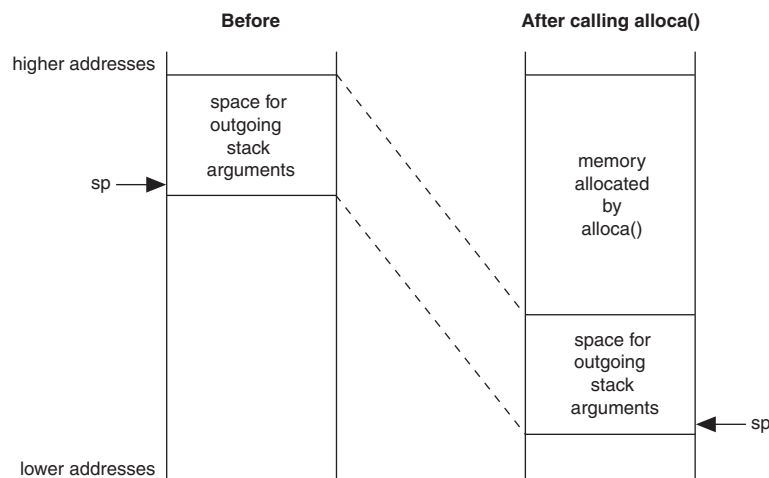

Stack Frame for a Function with Variable Arguments

Functions that take variable arguments (`varargs`) still have their first 16 bytes of arguments arriving in registers `r4` through `r7`, just like other functions.

In order for `varargs` to work, functions that take variable arguments allocate 16 extra bytes of storage on the stack. They copy to the stack the first 16 bytes of their arguments from registers `r4` through `r7` as shown in [Figure 7-3](#).

Figure 7-3. Stack Frame Using Variable Arguments

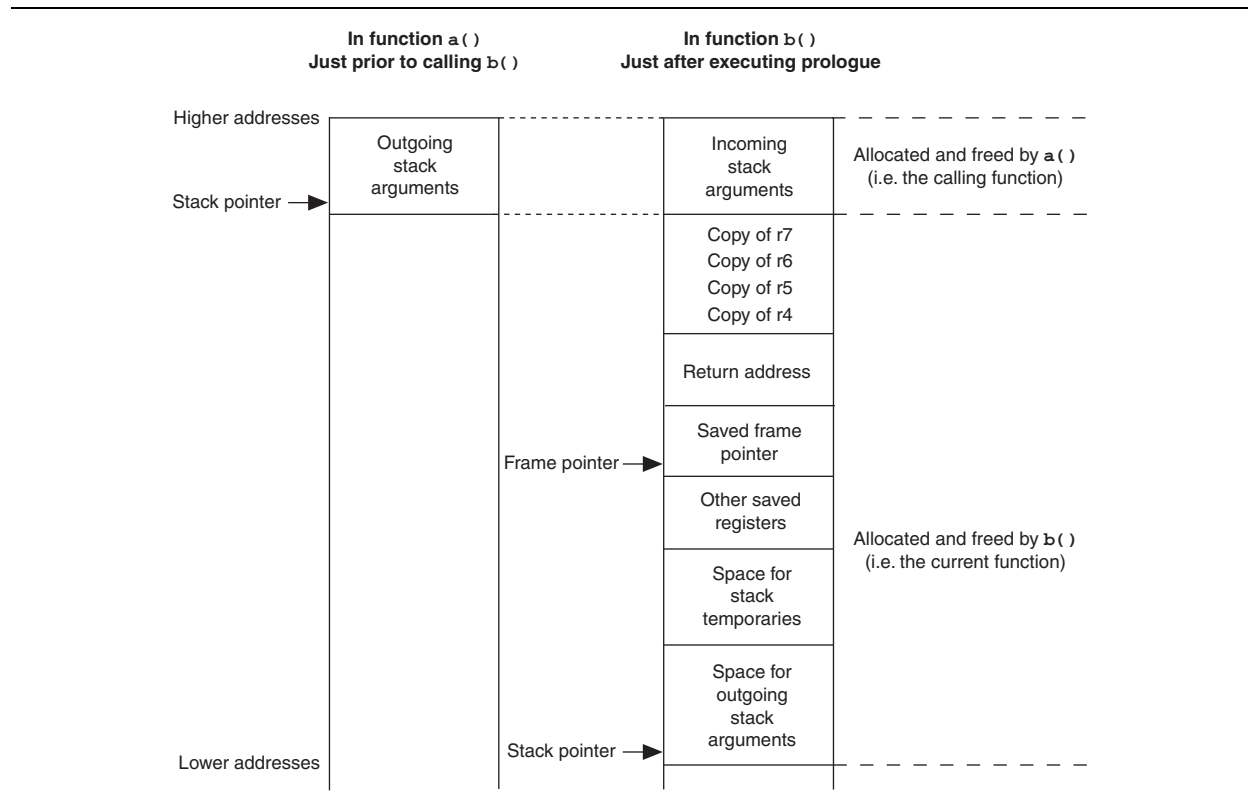

Stack Frame for a Function with Structures Passed By Value

Functions that take `struct` value arguments still have their first 16 bytes of arguments arriving in registers `r4` through `r7`, just like other functions.

If part of a structure is passed using registers, the function might need to copy the register contents back to the stack. This operation is similar to that required in the variable arguments case as shown in [Figure 7-3](#).

Function Prologues

The Nios II C/C++ compiler generates function prologues that allocate the stack frame of a function for storage of stack temporaries and outgoing arguments. In addition, each prologue is responsible for saving the state of the calling function. This entails saving certain registers on the stack. These registers, the callee-saved registers, are listed in [Table 7-2 on page 7-2](#). A function prologue is required to save a callee-saved register only if the function uses the register.

Given the function prologue algorithm, when doing a back trace, a debugger can disassemble instructions and reconstruct the processor state of the calling function.



An even better way to find out what the prologue has done is to use information stored in the DWARF2 debugging fields of the executable and linkable format (.elf) file.

The instructions found in a Nios II function prologue perform the following tasks:

- Adjust the stack pointer (to allocate the frame)
- Store registers to the frame
- Set the frame pointer to the location of the saved frame pointer

Example 7-1 shows a function prologue.

Example 7-1. A function prologue

```
/* Adjust the stack pointer */
addi    sp, sp, -16    /* make a 16-byte frame */

/* Store registers to the frame */
stw     ra, 12(sp)    /* store the return address */
stw     fp, 8(sp)     /* store the frame pointer*/
stw     r16, 4(sp)    /* store callee-saved register */
stw     r17, 0(sp)    /* store callee-saved register */

/* Set the new frame pointer */
addi    fp, sp, 8
```

Prologue Variations

The following variations can occur in a prologue:

- If the function's frame size is greater than 32,767 bytes, extra temporary registers are used in the calculation of the new stack pointer as well as for the offsets of where to store callee-saved registers. The extra registers are needed because of the maximum size of immediate values allowed by the Nios II processor.
- If the frame pointer is not in use, the final instruction, recalculating the frame pointer, is not generated.
- If variable arguments are used, extra instructions store the argument registers on the stack.
- If the compiler designates the function as a leaf function, the return address is not saved.
- If optimizations are on, especially instruction scheduling, the order of the instructions might change and become interlaced with instructions located after the prologue.

Arguments and Return Values

This section discusses the details of passing arguments to functions and returning values from functions.

Arguments

The first 16 bytes to a function are passed in registers r4 through r7. The arguments are passed as if a structure containing the types of the arguments were constructed, and the first 16 bytes of the structure are located in r4 through r7.

A simple example:

```
int function (int a, int b);
```

The equivalent structure representing the arguments is:

```
struct { int a; int b; };
```

The first 16 bytes of the struct are assigned to r4 through r7. Therefore r4 is assigned the value of *a* and r5 the value of *b*.

The first 16 bytes to a function taking variable arguments are passed the same way as a function not taking variable arguments. The called function must clean up the stack as necessary to support the variable arguments. Refer to [“Stack Frame for a Function with Variable Arguments”](#) on page 7-4.

Return Values

Return values of types up to 8 bytes are returned in r2 and r3. For return values greater than 8 bytes, the caller must allocate memory for the result and must pass the address of the result memory as a hidden zero argument.

The hidden zero argument is best explained through an example.

Example 7-2. Returned struct

```
/* b() computes a structure-type result and returns it */  
STRUCT b(int i, int j)  
{  
    ...  
    return result;  
}  
  
void a(...)  
{  
    ...  
    value = b(i, j);  
}
```

In [Example 7-2](#), if the result type is no larger than 8 bytes, `b()` returns its result in r2 and r3.

If the return type is larger than 8 bytes, the Nios II C/C++ compiler treats this program as if `a()` had passed a pointer to `b()`. [Example 7-3](#) shows how the Nios II C/C++ compiler sees the code in [Example 7-2](#).

Example 7-3. Returned struct is Larger than 8 Bytes

```

void b(STRUCT *p_result, int i, int j)
{
    ...
    *p_result = result;
}

void a(...)
{
    STRUCT value;
    ...
    b(*value, i, j);
}

```

Relocation

In a Nios II object file, each relocatable address reference possesses a relocation type. The relocation type specifies how to calculate the relocated address. [Table 7-3](#) lists the calculation for address relocation for each Nios II relocation type. The bit mask specifies where the address is found in the instruction.

Table 7-3. Nios II Relocation Calculation (Part 1 of 2)

Name	Value	Overflow check (1)	Relocated Address R (2)	Bit Mask M	Bit Shift B
R_NIOS2_NONE	0	n/a	None	n/a	n/a
R_NIOS2_S16	1	Yes	S + A	0x003FFFC0	6
R_NIOS2_U16	2	Yes	S + A	0x003FFFC0	6
R_NIOS2_PCREL16	3	Yes	((S + A) - 4) - PC	0x003FFFC0	6
R_NIOS2_CALL26	4	No	(S + A) >> 2	0xFFFFFC0	6
R_NIOS2_IMM5	5	Yes	(S + A) & 0x1F	0x000007C0	6
R_NIOS2_CACHE_OPX	6	Yes	(S + A) & 0x1F	0x07C00000	22
R_NIOS2_IMM6	7	Yes	(S + A) & 0x3F	0x00000FC0	6
R_NIOS2_IMM8	8	Yes	(S + A) & 0xFF	0x00003FC0	6
R_NIOS2_HI16	9	No	((S + A) >> 16) & 0xFFFF	0x003FFFC0	6
R_NIOS2_LO16	10	No	(S + A) & 0xFFFF	0x003FFFC0	6
R_NIOS2_HIADJ16	11	No	(((S+A) >> 16) & 0xFFFF) + (((S+A) >> 15) & 0x1) & 0xFFFF	0x003FFFC0	6
R_NIOS2_BFD_RELOC_32	12	No	S + A	0xFFFFFFFF	0
R_NIOS2_BFD_RELOC_16	13	Yes	(S + A) & 0xFFFF	0x0000FFFF	0
R_NIOS2_BFD_RELOC_8	14	Yes	(S + A) & 0xFF	0x000000FF	0
R_NIOS2_GPREL	15	No	(S + A - GP) & 0xFFFF	0x003FFFC0	6
R_NIOS2_GNU_VTINHERIT	16	n/a	None	n/a	n/a
R_NIOS2_GNU_VTENTRY	17	n/a	None	n/a	n/a
R_NIOS2_UJMP	18	No	((S + A) >> 16) & 0xFFFF, (S + A + 4) & 0xFFFF	0x003FFFC0	6

Table 7-3. Nios II Relocation Calculation (Part 2 of 2)

Name	Value	Overflow check (1)	Relocated Address R (2)	Bit Mask M	Bit Shift B
R_NIOS2_CJMP	19	No	$((S + A) \gg 16) \& 0xFFFF,$ $(S + A + 4) \& 0xFFFF$	0x003FFFC0	6
R_NIOS2_CALLR	20	No	$((S + A) \gg 16) \& 0xFFFF)$ $(S + A + 4) \& 0xFFFF$	0x003FFFC0	6
R_NIOS2_ALIGN	21	n/a	None	n/a	n/a
R_NIOS2_ILLEGAL	22	n/a	None	n/a	n/a

Notes to Table 7-3:

- (1) For relocation types where no overflow check is performed, the relocated address is truncated to fit the instruction.
- (2) S: Symbol address, A: Addend, PC: Program counter, GP: Global pointer

With the information in [Table 7-3](#), any Nios II instruction can be relocated by manipulating it as an unsigned 32-bit integer, as follows:

$$Xr = ((R \ll B) \& M \mid (X \& \sim M));$$

where:

- R is the relocated address, calculated as shown in [Table 7-3](#)
- B is the bit shift shown in [Table 7-3](#)
- M is the bit mask shown in [Table 7-3](#)
- X is the original instruction
- Xr is the relocated instruction

Validated Relocation Types

The Nios II C/C++ compiler generates and uses a subset of the available relocation types. The following five types are used frequently and have been thoroughly validated:

- R_NIOS2_HIADJ16
- R_NIOS2_LO16
- R_NIOS2_CALL26
- R_NIOS2_GPREL
- R_NIOS2_BFD_RELOC32

Other relocation types are not supported.

Referenced Documents

This chapter references the following documents:

- *Programming Model* chapter of the *Nios II Processor Reference Handbook*

Document Revision History

Table 7-4 shows the revision history for this document.

Table 7-4. Document Revision History

Date & Document Version	Changes Made	Summary of Changes
March 2009 v9.0.0	Maintenance release.	—
November 2008 v8.1.0	Maintenance release.	—
May 2008 v8.0.0	Frame pointer description updated Relocation table added	Frame pointer implementation redefined
October 2007 v7.2.0	Maintenance release.	—
May 2007 v7.1.0	<ul style="list-style-type: none"> ■ Added table of contents to Introduction section. ■ Added Referenced Documents section. 	—
March 2007 v7.0.0	Maintenance release.	—
November 2006 v6.1.0	Maintenance release.	—
May 2006 v6.0.0	Maintenance release.	—
October 2005 v5.1.0	Maintenance release.	—
May 2005 v5.0.0	Maintenance release.	—
May 2004 v1.0	Initial release.	—

Introduction

This section introduces the Nios® II instruction-word format and provides a detailed reference of the Nios II instruction set. This chapter contains the following sections:

- “Word Formats” on page 8–1
- “Instruction Opcodes” on page 8–2
- “Assembler Pseudo-Instructions” on page 8–3
- “Assembler Macros” on page 8–4
- “Instruction Set Reference” on page 8–4

Word Formats

There are three types of Nios II instruction word format: I-type, R-type, and J-type.

I-Type

The defining characteristic of the I-type instruction-word format is that it contains an immediate value embedded within the instruction word. I-type instructions words contain:

- A 6-bit opcode field OP
- Two 5-bit register fields A and B
- A 16-bit immediate data field IMM16

In most cases, fields A and IMM16 specify the source operands, and field B specifies the destination register. IMM16 is considered signed except for logical operations and unsigned comparisons.

I-type instructions include arithmetic and logical operations such as `addi` and `andi`; branch operations; load and store operations; and cache management operations.

The I-type instruction format is:

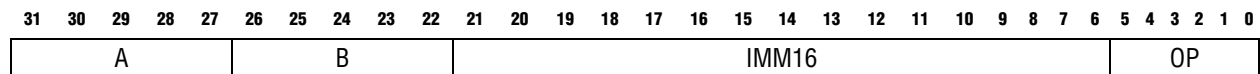

R-Type

The defining characteristic of the R-type instruction-word format is that all arguments and results are specified as registers. R-type instructions contain:

- A 6-bit opcode field OP
- Three 5-bit register fields A, B, and C
- An 11-bit opcode-extension field OPX

In most cases, fields A and B specify the source operands, and field C specifies the destination register. Some R-Type instructions embed a small immediate value in the low-order bits of OPX.

R-type instructions include arithmetic and logical operations such as `add` and `nor`; comparison operations such as `cmpeq` and `cmplt`; the custom instruction; and other operations that need only register operands.

The R-type instruction format is:

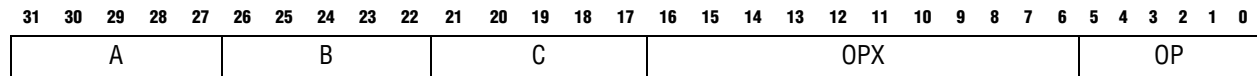

J-Type

J-type instructions contain:

- A 6-bit opcode field
- A 26-bit immediate data field

J-type instructions, such as `call` and `jmpi`, transfer execution anywhere within a 256 MByte range.

The J-type instruction format is:

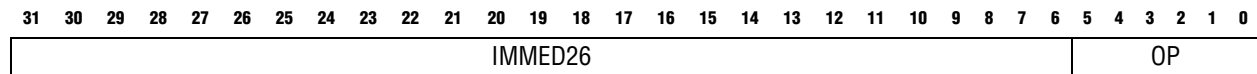

Instruction Opcodes

The OP field in the Nios II instruction word specifies the major class of an opcode as shown in [Table 8-1](#) and [Table 8-2](#). Most values of OP are encodings for I-type instructions. One encoding, OP = 0x00, is the J-type instruction `call`. Another encoding, OP = 0x3a, is used for all R-type instructions, in which case, the OPX field differentiates the instructions. All undefined encodings of OP and OPX are reserved.

Table 8-1. OP Encodings (Part 1 of 2)

OP	Instruction	OP	Instruction	OP	Instruction	OP	Instruction
0x00	<code>call</code>	0x10	<code>cmplti</code>	0x20	<code>cmpeqi</code>	0x30	<code>cmpltui</code>
0x01	<code>jmp<i>i</i></code>	0x11		0x21		0x31	
0x02		0x12		0x22		0x32	<code>custom</code>
0x03	<code>ldbu</code>	0x13	<code>initda</code>	0x23	<code>ldbuio</code>	0x33	<code>initd</code>
0x04	<code>addi</code>	0x14	<code>ori</code>	0x24	<code>muli</code>	0x34	<code>orhi</code>
0x05	<code>stb</code>	0x15	<code>stw</code>	0x25	<code>stbio</code>	0x35	<code>stwio</code>
0x06	<code>br</code>	0x16	<code>blt</code>	0x26	<code>beq</code>	0x36	<code>bltu</code>
0x07	<code>ldb</code>	0x17	<code>ldw</code>	0x27	<code>ldbio</code>	0x37	<code>ldwio</code>
0x08	<code>cmpgei</code>	0x18	<code>cmpnei</code>	0x28	<code>cmpgeui</code>	0x38	
0x09		0x19		0x29		0x39	
0x0A		0x1A		0x2A		0x3A	R-type

Table 8-1. OP Encodings (Part 2 of 2)

OP	Instruction	OP	Instruction	OP	Instruction	OP	Instruction
0x0B	ldhu	0x1B	flushda	0x2B	ldhuio	0x3B	flushd
0x0C	andi	0x1C	xori	0x2C	andhi	0x3C	xorhi
0x0D	sth	0x1D		0x2D	sthio	0x3D	
0x0E	bge	0x1E	bne	0x2E	bgeu	0x3E	
0x0F	ldh	0x1F		0x2F	ldhio	0x3F	

Table 8-2. OPX Encodings for R-Type Instructions

OPX	Instruction	OPX	Instruction	OPX	Instruction	OPX	Instruction
0x00		0x10	cmplt	0x20	cmpeq	0x30	cmpltu
0x01	eret	0x11		0x21		0x31	add
0x02	roli	0x12	slli	0x22		0x32	
0x03	rol	0x13	sll	0x23		0x33	
0x04	flushp	0x14		0x24	divu	0x34	break
0x05	ret	0x15		0x25	div	0x35	
0x06	nor	0x16	or	0x26	rdctl	0x36	sync
0x07	mulxuu	0x17	mulxsu	0x27	mul	0x37	
0x08	cmpge	0x18	cmpne	0x28	cmpgeu	0x38	
0x09	bret	0x19		0x29	initi	0x39	sub
0x0A		0x1A	srl	0x2A		0x3A	srai
0x0B	ror	0x1B	srl	0x2B		0x3B	sra
0x0C	flushi	0x1C	nextpc	0x2C		0x3C	
0x0D	jmp	0x1D	callr	0x2D	trap	0x3D	
0x0E	and	0x1E	xor	0x2E	wrctl	0x3E	
0x0F		0x1F	mulxss	0x2F		0x3F	

Assembler Pseudo-Instructions

Table 8-3 lists pseudo-instructions available in Nios II assembly language. Pseudo-instructions are used in assembly source code like regular assembly instructions. Each pseudo-instruction is implemented at the machine level using an equivalent instruction. The `movia` pseudo-instruction is the only exception, being implemented with two instructions. Most pseudo-instructions do not appear in disassembly views of machine code.

Table 8-3. Assembler Pseudo-Instructions (Part 1 of 2)

Pseudo-Instruction	Equivalent Instruction
<code>bgt rA, rB, label</code>	<code>blt rB, rA, label</code>
<code>bgtu rA, rB, label</code>	<code>bltu rB, rA, label</code>
<code>ble rA, rB, label</code>	<code>bge rB, rA, label</code>
<code>bleu rA, rB, label</code>	<code>bgeu rB, rA, label</code>
<code>cmpgt rC, rA, rB</code>	<code>cmplt rC, rB, rA</code>

Table 8-3. Assembler Pseudo-Instructions (Part 2 of 2)

Pseudo-Instruction	Equivalent Instruction
cmpgti rB, rA, IMMED	cmpgei rB, rA, (IMMED+1)
cmpgtu rC, rA, rB	cmpltu rC, rB, rA
cmpgtui rB, rA, IMMED	cmpgeui rB, rA, (IMMED+1)
cmple rC, rA, rB	cmpge rC, rB, rA
cmplei rB, rA, IMMED	cmplti rB, rA, (IMMED+1)
cmpleu rC, rA, rB	cmpgeu rC, rB, rA
cmpleui rB, rA, IMMED	cmpltui rB, rA, (IMMED+1)
mov rC, rA	add rC, rA, r0
movhi rB, IMMED	orhi rB, r0, IMMED
movi rB, IMMED	addi, rB, r0, IMMED
movia rB, label	orhi rB, r0, %hiadj(label) addi, rB, r0, %lo(label)
movui rB, IMMED	ori rB, r0, IMMED
nop	add r0, r0, r0
subi rB, rA, IMMED	addi rB, rA, (-IMMED)

Assembler Macros

The Nios II assembler provides macros to extract halfwords from labels and from 32-bit immediate values. [Table 8-4](#) lists the available macros. These macros return 16-bit signed values or 16-bit unsigned values depending on where they are used. When used with an instruction that requires a 16-bit signed immediate value, these macros return a value ranging from -32768 to 32767. When used with an instruction that requires a 16-bit unsigned immediate value, these macros return a value ranging from 0 to 65535.

Table 8-4. Assembler Macros

Macro	Description	Operation
%lo(immed32)	Extract bits [15..0] of immed32	immed32 & 0xffff
%hi(immed32)	Extract bits [31..16] of immed32	(immed32 >> 16) & 0xffff
%hiadj(immed32)	Extract bits [31..16] and adds bit 15 of immed32	((immed32 >> 16) & 0xffff) + ((immed32 >> 15) & 0x1)
%gprel(immed32)	Replace the immed32 address with an offset from the global pointer (1)	immed32 -_gp

Note to [Table 8-4](#):

(1) Refer to the [Application Binary Interface](#) chapter of the *Nios II Processor Reference Handbook* for more information about global pointers.

Instruction Set Reference

The following pages list all Nios II instruction mnemonics in alphabetical order. [Table 8-5](#) shows the notation conventions used to describe instruction operation.

Table 8-5. Notation Conventions

Notation	Meaning
$X \leftarrow Y$	X is written with Y
$PC \leftarrow X$	The program counter (PC) is written with address X; the instruction at X will be the next instruction to execute
PC	The address of the assembly instruction in question
rA, rB, rC	One of the 32-bit general-purpose registers
IMM n	An n -bit immediate value, embedded in the instruction word
IMMED	An immediate value
X_n	The n^{th} bit of X, where $n = 0$ is the LSB
$X_{n..m}$	Consecutive bits n through m of X
0xNNMM	Hexadecimal notation
X : Y	Bitwise concatenation For example, (0x12 : 0x34) = 0x1234
$\alpha(X)$	The value of X after being sign-extended to a full register-sized signed integer
$X \gg n$	The value X after being right-shifted n bit positions
$X \ll n$	The value X after being left-shifted n bit positions
$X \& Y$	Bitwise logical AND
$X Y$	Bitwise logical OR
$X \wedge Y$	Bitwise logical XOR
$\sim X$	Bitwise logical NOT (one's complement)
Mem8[X]	The byte located in data memory at byte-address X
Mem16[X]	The halfword located in data memory at byte-address X
Mem32[X]	The word located in data memory at byte-address X
label	An address label specified in the assembly file
(signed) rX	The value of rX treated as a signed number
(unsigned) rX	The value of rX treated as an unsigned number

The following exceptions are not listed for each instruction because they can occur on any instruction fetch:

- Supervisor-only instruction address
- Fast TLB miss (instruction)
- Double TLB miss (instruction)
- TLB permission violation (execute)
- MPU region violation (instruction)



For details on these and all Nios II exceptions, refer to the *Programming Model* chapter of the *Nios II Processor Reference Handbook*.

add**add****Operation:** $rC \leftarrow rA + rB$ **Assembler Syntax:** `add rC, rA, rB`**Example:** `add r6, r7, r8`**Description:** Calculates the sum of rA and rB. Stores the result in rC. Used for both signed and unsigned addition.**Usage: Carry Detection (unsigned operands):**

Following an `add` operation, a carry out of the MSB can be detected by checking whether the unsigned sum is less than one of the unsigned operands. The carry bit can be written to a register, or a conditional branch can be taken based on the carry condition. Both cases are shown below.

```
add rC, rA, rB           ; The original add operation
cmpltu rD, rC, rA       ; rD is written with the carry bit
```

```
add rC, rA, rB           ; The original add operation
bltu rC, rA, label      ; Branch if carry was generated
```

Overflow Detection (signed operands):

An overflow is detected when two positives are added and the sum is negative, or when two negatives are added and the sum is positive. The overflow condition can control a conditional branch, as shown below.

```
add rC, rA, rB           ; The original add operation
xor rD, rC, rA           ; Compare signs of sum and rA
xor rE, rC, rB           ; Compare signs of sum and rB
and rD, rD, rE           ; Combine comparisons
blt rD, r0, label       ; Branch if overflow occurred
```

Exceptions: None**Instruction Type:** R

Instruction Fields: A = Register index of operand rA
B = Register index of operand rB
C = Register index of operand rC

31	30	29	28	27	26	25	24	23	22	21	20	19	18	17	16	15	14	13	12	11	10	9	8	7	6	5	4	3	2	1	0
A					B					C					0x31					0					0x3a						

addi

add immediate

- Operation:** $rB \leftarrow rA + \sigma(\text{IMM16})$
- Assembler Syntax:** `addi rB, rA, IMM16`
- Example:** `addi r6, r7, -100`
- Description:** Sign-extends the 16-bit immediate value and adds it to the value of rA. Stores the sum in rB.

Usage: **Carry Detection (unsigned operands):**

Following an `addi` operation, a carry out of the MSB can be detected by checking whether the unsigned sum is less than one of the unsigned operands. The carry bit can be written to a register, or a conditional branch can be taken based on the carry condition. Both cases are shown below.

```
addi rB, rA, IMM16      ; The original add operation
cmltu rD, rB, rA        ; rD is written with the carry bit
```

```
addi rB, rA, IMM16      ; The original add operation
bltu rB, rA, label      ; Branch if carry was generated
```

Overflow Detection (signed operands):

An overflow is detected when two positives are added and the sum is negative, or when two negatives are added and the sum is positive. The overflow condition can control a conditional branch, as shown below.

```
addi rB, rA, IMM16      ; The original add operation
xor rC, rB, rA          ; Compare signs of sum and rA
xorhi rD, rB, IMM16     ; Compare signs of sum and IMM16
and rC, rC, rD          ; Combine comparisons
blt rC, r0, label       ; Branch if overflow occurred
```

Exceptions: None

Instruction Type: I

Instruction Fields: A = Register index of operand rA
 B = Register index of operand rB
 IMM16 = 16-bit signed immediate value

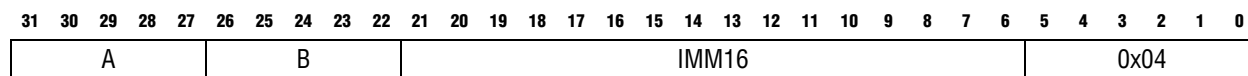

and**bitwise logical and**

Operation: $rC \leftarrow rA \& rB$

Assembler Syntax: `and rC, rA, rB`

Example: `and r6, r7, r8`

Description: Calculates the bitwise logical AND of rA and rB and stores the result in rC.

Exceptions: None

Instruction Type: R

Instruction Fields: A = Register index of operand rA
B = Register index of operand rB
C = Register index of operand rC

31	30	29	28	27	26	25	24	23	22	21	20	19	18	17	16	15	14	13	12	11	10	9	8	7	6	5	4	3	2	1	0
A								B								C				0x0e				0				0x3a			

andhi bitwise logical and immediate into high halfword

Operation: $rB \leftarrow rA \& (IMM16 : 0x0000)$

Assembler Syntax: `andhi rB, rA, IMM16`

Example: `andhi r6, r7, 100`

Description: Calculates the bitwise logical AND of rA and (IMM16 : 0x0000) and stores the result in rB.

Exceptions: None

Instruction Type: I

Instruction Fields: A = Register index of operand rA
 B = Register index of operand rB
 IMM16 = 16-bit unsigned immediate value

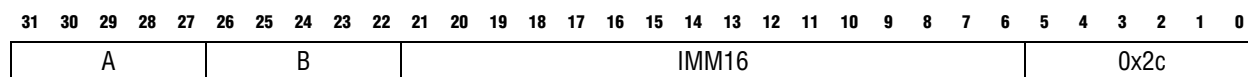

andi**bitwise logical and immediate****Operation:** $rB \leftarrow rA \ \& \ (0x0000 : IMM16)$ **Assembler Syntax:** `andi rB, rA, IMM16`**Example:** `andi r6, r7, 100`**Description:** Calculates the bitwise logical AND of rA and (0x0000 : IMM16) and stores the result in rB.**Exceptions:** None**Instruction Type:** I**Instruction Fields:**
A = Register index of operand rA
B = Register index of operand rB
IMM16 = 16-bit unsigned immediate value

31	30	29	28	27	26	25	24	23	22	21	20	19	18	17	16	15	14	13	12	11	10	9	8	7	6	5	4	3	2	1	0
A				B				IMM16												0x0c											

beq

branch if equal

- Operation:** if ($rA == rB$)
 then $PC \leftarrow PC + 4 + \sigma(\text{IMM16})$
 else $PC \leftarrow PC + 4$
- Assembler Syntax:** `beq rA, rB, label`
- Example:** `beq r6, r7, label`
- Description:** If $rA == rB$, then `beq` transfers program control to the instruction at label. In the instruction encoding, the offset given by IMM16 is treated as a signed number of bytes relative to the instruction immediately following `beq`. The two least-significant bits of IMM16 are always zero, because instruction addresses must be word-aligned.
- Exceptions:** Misaligned destination address
- Instruction Type:** I
- Instruction Fields:** A = Register index of operand rA
 B = Register index of operand rB
 IMM16 = 16-bit signed immediate value

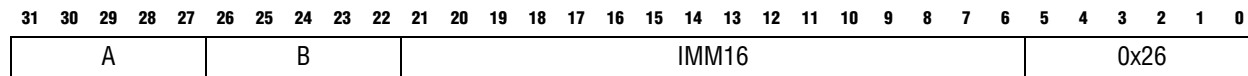

bge**branch if greater than or equal signed**

Operation: if ((signed) rA >= (signed) rB)
then PC ← PC + 4 + σ(IMM16)
else PC ← PC + 4

Assembler Syntax: bge rA, rB, label

Example: bge r6, r7, top_of_loop

Description: If (signed) rA >= (signed) rB, then `bge` transfers program control to the instruction at label. In the instruction encoding, the offset given by IMM16 is treated as a signed number of bytes relative to the instruction immediately following `bge`. The two least-significant bits of IMM16 are always zero, because instruction addresses must be word-aligned.

Exceptions: Misaligned destination address

Instruction Type: I

Instruction Fields: A = Register index of operand rA
B = Register index of operand rB
IMM16 = 16-bit signed immediate value

31	30	29	28	27	26	25	24	23	22	21	20	19	18	17	16	15	14	13	12	11	10	9	8	7	6	5	4	3	2	1	0
A				B				IMM16												0x0e											

bgeu

branch if greater than or equal unsigned

Operation: if ((unsigned) rA >= (unsigned) rB)
 then PC ← PC + 4 + σ(IMM16)
 else PC ← PC + 4

Assembler Syntax: bgeu rA, rB, label

Example: bgeu r6, r7, top_of_loop

Description: If (unsigned) rA >= (unsigned) rB, then bgeu transfers program control to the instruction at label. In the instruction encoding, the offset given by IMM16 is treated as a signed number of bytes relative to the instruction immediately following bgeu. The two least-significant bits of IMM16 are always zero, because instruction addresses must be word-aligned.

Exceptions: Misaligned destination address

Instruction Type: I

Instruction Fields: A = Register index of operand rA
 B = Register index of operand rB
 IMM16 = 16-bit signed immediate value

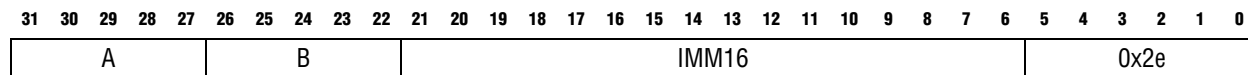

bgt**branch if greater than signed**

Operation:	if ((signed) rA > (signed) rB) then PC ← label else PC ← PC + 4
Assembler Syntax:	bgt rA, rB, label
Example:	bgt r6, r7, top_of_loop
Description:	If (signed) rA > (signed) rB, then bgt transfers program control to the instruction at label.
Pseudo-instruction:	bgt is implemented with the blt instruction by swapping the register operands.

bgtu

branch if greater than unsigned

Operation:	if ((unsigned) rA > (unsigned) rB) then PC ← label else PC ← PC + 4
Assembler Syntax:	bgtu rA, rB, label
Example:	bgtu r6, r7, top_of_loop
Description:	If (unsigned) rA > (unsigned) rB, then <code>bgtu</code> transfers program control to the instruction at label.
Pseudo-instruction:	<code>bgtu</code> is implemented with the <code>b1tu</code> instruction by swapping the register operands.

ble**branch if less than or equal signed**

Operation:	if ((signed) rA <= (signed) rB) then PC ← label else PC ← PC + 4
Assembler Syntax:	ble rA, rB, label
Example:	ble r6, r7, top_of_loop
Description:	If (signed) rA <= (signed) rB, then ble transfers program control to the instruction at label.
Pseudo-instruction:	ble is implemented with the bge instruction by swapping the register operands.

bleu

branch if less than or equal to unsigned

Operation:	if ((unsigned) rA <= (unsigned) rB) then PC ← label else PC ← PC + 4
Assembler Syntax:	bleu rA, rB, label
Example:	bleu r6, r7, top_of_loop
Description:	If (unsigned) rA <= (unsigned) rB, then bleu transfers program counter to the instruction at label.
Pseudo-instruction:	bleu is implemented with the bgeu instruction by swapping the register operands.

blt**branch if less than signed**

Operation: if ((signed) rA < (signed) rB)
then PC ← PC + 4 + σ(IMM16)
else PC ← PC + 4

Assembler Syntax: `blt rA, rB, label`

Example: `blt r6, r7, top_of_loop`

Description: If (signed) rA < (signed) rB, then `blt` transfers program control to the instruction at label. In the instruction encoding, the offset given by IMM16 is treated as a signed number of bytes relative to the instruction immediately following `blt`. The two least-significant bits of IMM16 are always zero, because instruction addresses must be word-aligned.

Exceptions: Misaligned destination address

Instruction Type: I

Instruction Fields: A = Register index of operand rA
B = Register index of operand rB
IMM16 = 16-bit signed immediate value

31	30	29	28	27	26	25	24	23	22	21	20	19	18	17	16	15	14	13	12	11	10	9	8	7	6	5	4	3	2	1	0
A				B				IMM16												0x16											

bltu

branch if less than unsigned

Operation: if ((unsigned) rA < (unsigned) rB)
 then PC ← PC + 4 + σ(IMM16)
 else PC ← PC + 4

Assembler Syntax: bltu rA, rB, label

Example: bltu r6, r7, top_of_loop

Description: If (unsigned) rA < (unsigned) rB, then bltu transfers program control to the instruction at label. In the instruction encoding, the offset given by IMM16 is treated as a signed number of bytes relative to the instruction immediately following bltu. The two least-significant bits of IMM16 are always zero, because instruction addresses must be word-aligned.

Exceptions: Misaligned destination address

Instruction Type: I

Instruction Fields: A = Register index of operand rA
 B = Register index of operand rB
 IMM16 = 16-bit signed immediate value

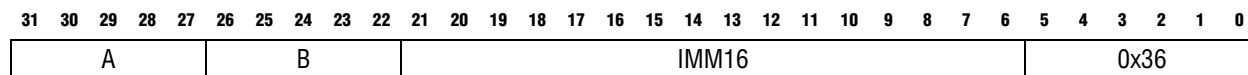

bne**branch if not equal**

Operation:	if ($rA \neq rB$) then $PC \leftarrow PC + 4 + \sigma(\text{IMM16})$ else $PC \leftarrow PC + 4$
Assembler Syntax:	<code>bne rA, rB, label</code>
Example:	<code>bne r6, r7, top_of_loop</code>
Description:	If $rA \neq rB$, then <code>bne</code> transfers program control to the instruction at <code>label</code> . In the instruction encoding, the offset given by <code>IMM16</code> is treated as a signed number of bytes relative to the instruction immediately following <code>bne</code> . The two least-significant bits of <code>IMM16</code> are always zero, because instruction addresses must be word-aligned.
Exceptions:	Misaligned destination address
Instruction Type:	I
Instruction Fields:	A = Register index of operand rA B = Register index of operand rB IMM16 = 16-bit signed immediate value

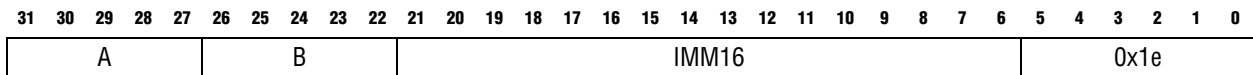

br

unconditional branch

Operation: $PC \leftarrow PC + 4 + \sigma(IMM16)$

Assembler Syntax: `br label`

Example: `br top_of_loop`

Description: Transfers program control to the instruction at label. In the instruction encoding, the offset given by IMM16 is treated as a signed number of bytes relative to the instruction immediately following `br`. The two least-significant bits of IMM16 are always zero, because instruction addresses must be word-aligned.

Exceptions: Misaligned destination address

Instruction Type: I

Instruction Fields: IMM16 = 16-bit signed immediate value

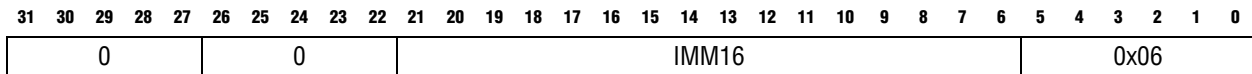

break**debugging breakpoint**

Operation: $bstatus \leftarrow status$
 $PIE \leftarrow 0$
 $U \leftarrow 0$
 $ba \leftarrow PC + 4$
 $PC \leftarrow \text{break handler address}$

Assembler Syntax: `break`
`break imm5`

Example: `break`

Description: Breaks program execution and transfers control to the debugger break-processing routine. Saves the address of the next instruction in register `ba` and saves the contents of the `status` register in `bstatus`. Disables interrupts, then transfers execution to the break handler.

The 5-bit immediate field `imm5` is ignored by the processor, but it can be used by the debugger.

`break` with no argument is the same as `break 0`.

Usage: `break` is used by debuggers exclusively. Only debuggers should place `break` in a user program, operating system, or exception handler. The address of the break handler is specified at system generation time.

Some debuggers support `break` and `break 0` instructions in source code. These debuggers treat the `break` instruction as a normal breakpoint.

Exceptions: Break

Instruction Type: R

Instruction Fields: IMM5 = Type of breakpoint

31	30	29	28	27	26	25	24	23	22	21	20	19	18	17	16	15	14	13	12	11	10	9	8	7	6	5	4	3	2	1	0
0					0					0x1e					0x34					IMM5					0x3a						

bret

breakpoint return

Operation:	$status \leftarrow bstatus$ $PC \leftarrow ba$
Assembler Syntax:	bret
Example:	bret
Description:	Copies the value of <code>bstatus</code> to the <code>status</code> register, then transfers execution to the address in <code>ba</code> .
Usage:	<code>bret</code> is used by debuggers exclusively and should not appear in user programs, operating systems, or exception handlers.
Exceptions:	Misaligned destination address Supervisor-only instruction
Instruction Type:	R
Instruction Fields:	None

31	30	29	28	27	26	25	24	23	22	21	20	19	18	17	16	15	14	13	12	11	10	9	8	7	6	5	4	3	2	1	0
0x1e				0				0				0x09				0				0x3a											

call**call subroutine**

Operation:	$ra \leftarrow PC + 4$ $PC \leftarrow (PC_{31..28} : IMM26 \times 4)$
Assembler Syntax:	<code>call label</code>
Example:	<code>call write_char</code>
Description:	Saves the address of the next instruction in register <code>ra</code> , and transfers execution to the instruction at address $(PC_{31..28} : IMM26 \times 4)$.
Usage:	<code>call</code> can transfer execution anywhere within the 256 MByte range determined by $PC_{31..28}$. The Nios II GNU linker does not automatically handle cases in which the address is out of this range.
Exceptions:	None
Instruction Type:	J
Instruction Fields:	IMM26 = 26-bit unsigned immediate value

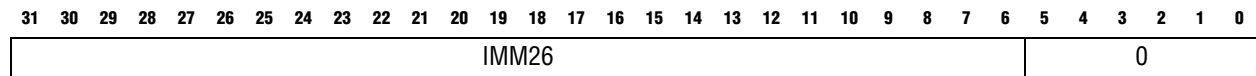

callr

call subroutine in register

Operation: $ra \leftarrow PC + 4$
 $PC \leftarrow rA$

Assembler Syntax: `callr rA`

Example: `callr r6`

Description: Saves the address of the next instruction in the return-address register, and transfers execution to the address contained in register rA.

Usage: `callr` is used to dereference C-language function pointers.

Exceptions: Misaligned destination address

Instruction Type: R

Instruction Fields: A = Register index of operand rA

31	30	29	28	27	26	25	24	23	22	21	20	19	18	17	16	15	14	13	12	11	10	9	8	7	6	5	4	3	2	1	0
A				0				0x1f				0x1d				0				0x3a											

cmpeq**compare equal**

Operation:	if (rA == rB) then rC ← 1 else rC ← 0
Assembler Syntax:	cmpeq rC, rA, rB
Example:	cmpeq r6, r7, r8
Description:	If rA == rB, then stores 1 to rC; otherwise, stores 0 to rC.
Usage:	cmpeq performs the == operation of the C programming language. Also, cmpeq can be used to implement the C logical-negation operator "!". cmpeq rC, rA, r0 ; Implements rC = !rA
Exceptions:	None
Instruction Type:	R
Instruction Fields:	A = Register index of operand rA B = Register index of operand rB C = Register index of operand rC

31	30	29	28	27	26	25	24	23	22	21	20	19	18	17	16	15	14	13	12	11	10	9	8	7	6	5	4	3	2	1	0
A				B				C				0x20				0				0x3a											

cmpeqi

compare equal immediate

- Operation:** if ($rA \sigma (IMM16)$)
 then $rB \leftarrow 1$
 else $rB \leftarrow 0$
- Assembler Syntax:** `cmpeqi rB, rA, IMM16`
- Example:** `cmpeqi r6, r7, 100`
- Description:** Sign-extends the 16-bit immediate value IMM16 to 32 bits and compares it to the value of rA. If $rA == \sigma (IMM16)$, `cmpeqi` stores 1 to rB; otherwise stores 0 to rB.
- Usage:** `cmpeqi` performs the `==` operation of the C programming language.
- Exceptions:** None
- Instruction Type:** I
- Instruction Fields:** A = Register index of operand rA
 B = Register index of operand rB
 IMM16 = 16-bit signed immediate value

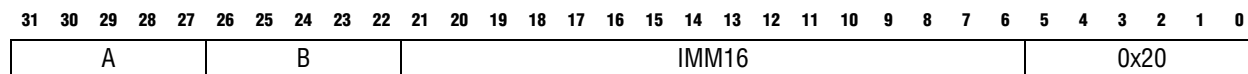

cmpge**compare greater than or equal signed**

Operation:	if ((signed) rA >= (signed) rB) then rC ← 1 else rC ← 0
Assembler Syntax:	cmpge rC, rA, rB
Example:	cmpge r6, r7, r8
Description:	If rA >= rB, then stores 1 to rC; otherwise stores 0 to rC.
Usage:	cmpge performs the signed >= operation of the C programming language.
Exceptions:	None
Instruction Type:	R
Instruction Fields:	A = Register index of operand rA B = Register index of operand rB C = Register index of operand rC

31	30	29	28	27	26	25	24	23	22	21	20	19	18	17	16	15	14	13	12	11	10	9	8	7	6	5	4	3	2	1	0
A				B				C				0x08				0				0x3a											

cmpgei compare greater than or equal signed immediate

Operation: if ((signed) rA >= (signed) σ (IMM16))
 then rB \leftarrow 1
 else rB \leftarrow 0

Assembler Syntax: `cmpgei rB, rA, IMM16`

Example: `cmpgei r6, r7, 100`

Description: Sign-extends the 16-bit immediate value IMM16 to 32 bits and compares it to the value of rA. If rA >= α (IMM16), then `cmpgei` stores 1 to rB; otherwise stores 0 to rB.

Usage: `cmpgei` performs the signed >= operation of the C programming language.

Exceptions: None

Instruction Type: R

Instruction Fields: A = Register index of operand rA
 B = Register index of operand rB
 IMM16 = 16-bit signed immediate value

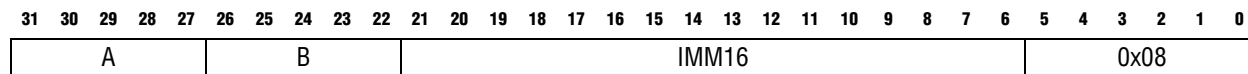

cmpgeu**compare greater than or equal unsigned**

Operation:	if ((unsigned) rA >= (unsigned) rB) then rC ← 1 else rC ← 0
Assembler Syntax:	cmpgeu rC, rA, rB
Example:	cmpgeu r6, r7, r8
Description:	If rA >= rB, then stores 1 to rC; otherwise stores 0 to rC.
Usage:	cmpgeu performs the unsigned >= operation of the C programming language.
Exceptions:	None
Instruction Type:	R
Instruction Fields:	A = Register index of operand rA B = Register index of operand rB C = Register index of operand rC

31	30	29	28	27	26	25	24	23	22	21	20	19	18	17	16	15	14	13	12	11	10	9	8	7	6	5	4	3	2	1	0
A				B				C				0x28				0				0x3a											

cmpgeui compare greater than or equal unsigned immediate

Operation: if ((unsigned) rA >= (unsigned) (0x0000 : IMM16))
 then rB ← 1
 else rB ← 0

Assembler Syntax: `cmpgeui rB, rA, IMM16`

Example: `cmpgeui r6, r7, 100`

Description: Zero-extends the 16-bit immediate value IMM16 to 32 bits and compares it to the value of rA. If rA >= (0x0000 : IMM16), then `cmpgeui` stores 1 to rB; otherwise stores 0 to rB.

Usage: `cmpgeui` performs the unsigned >= operation of the C programming language.

Exceptions: None

Instruction Type: I

Instruction Fields: A = Register index of operand rA
 B = Register index of operand rB
 IMM16 = 16-bit unsigned immediate value

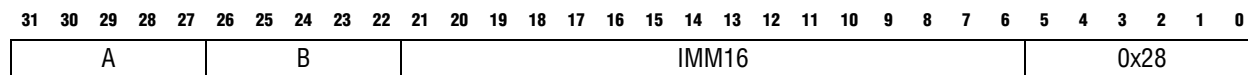

cmpgt**compare greater than signed**

Operation:	if ((signed) rA > (signed) rB) then rC ← 1 else rC ← 0
Assembler Syntax:	cmpgt rC, rA, rB
Example:	cmpgt r6, r7, r8
Description:	If rA > rB, then stores 1 to rC; otherwise stores 0 to rC.
Usage:	cmpgt performs the signed > operation of the C programming language.
Pseudo-instruction:	cmpgt is implemented with the <code>cmplt</code> instruction by swapping its rA and rB operands.

cmpgti

compare greater than signed immediate

Operation:	if ((signed) rA > (signed) IMMED) then rB ← 1 else rB ← 0
Assembler Syntax:	cmpgti rB, rA, IMMED
Example:	cmpgti r6, r7, 100
Description:	Sign-extends the immediate value IMMED to 32 bits and compares it to the value of rA. If rA > α (IMMED), then <code>cmpgti</code> stores 1 to rB; otherwise stores 0 to rB.
Usage:	<code>cmpgti</code> performs the signed > operation of the C programming language. The maximum allowed value of IMMED is 32766. The minimum allowed value is -32769.
Pseudo-instruction:	<code>cmpgti</code> is implemented using a <code>cmpgei</code> instruction with an IMM16 immediate value of IMMED + 1.

cmpgtu**compare greater than unsigned**

Operation:	if ((unsigned) rA > (unsigned) rB) then rC ← 1 else rC ← 0
Assembler Syntax:	cmpgtu rC, rA, rB
Example:	cmpgtu r6, r7, r8
Description:	If rA > rB, then stores 1 to rC; otherwise stores 0 to rC.
Usage:	cmpgtu performs the unsigned > operation of the C programming language.
Pseudo-instruction:	cmpgtu is implemented with the <code>cmpltu</code> instruction by swapping its rA and rB operands.

cmpgtui

compare greater than unsigned immediate

Operation:	if ((unsigned) rA > (unsigned) IMMED) then rB ← 1 else rB ← 0
Assembler Syntax:	cmpgtui rB, rA, IMMED
Example:	cmpgtui r6, r7, 100
Description:	Zero-extends the immediate value IMMED to 32 bits and compares it to the value of rA. If rA > IMMED, then <code>cmpgtui</code> stores 1 to rB; otherwise stores 0 to rB.
Usage:	<code>cmpgtui</code> performs the unsigned > operation of the C programming language. The maximum allowed value of IMMED is 65534. The minimum allowed value is 0.
Pseudo-instruction:	<code>cmpgtui</code> is implemented using a <code>cmpgeui</code> instruction with an IMM16 immediate value of IMMED + 1.

cmple**compare less than or equal signed**

Operation:	if ((signed) rA <= (signed) rB) then rC ← 1 else rC ← 0
Assembler Syntax:	cmple rC, rA, rB
Example:	cmple r6, r7, r8
Description:	If rA <= rB, then stores 1 to rC; otherwise stores 0 to rC.
Usage:	cmple performs the signed <= operation of the C programming language.
Pseudo-instruction:	cmple is implemented with the cmpge instruction by swapping its rA and rB operands.

cmplei

compare less than or equal signed immediate

Operation:	if ((signed) rA < (signed) IMMED) then rB ← 1 else rB ← 0
Assembler Syntax:	<code>cmplei rB, rA, IMMED</code>
Example:	<code>cmplei r6, r7, 100</code>
Description:	Sign-extends the immediate value IMMED to 32 bits and compares it to the value of rA. If $rA \leq \alpha(\text{IMMED})$, then <code>cmplei</code> stores 1 to rB; otherwise stores 0 to rB.
Usage:	<code>cmplei</code> performs the signed \leq operation of the C programming language. The maximum allowed value of IMMED is 32766. The minimum allowed value is -32769.
Pseudo-instruction:	<code>cmplei</code> is implemented using a <code>cmplti</code> instruction with an IMM16 immediate value of IMMED + 1.

cmpleu**compare less than or equal unsigned**

Operation:	if ((unsigned) rA < (unsigned) rB) then rC ← 1 else rC ← 0
Assembler Syntax:	<code>cmpleu rC, rA, rB</code>
Example:	<code>cmpleu r6, r7, r8</code>
Description:	If rA ≤ rB, then stores 1 to rC; otherwise stores 0 to rC.
Usage:	<code>cmpleu</code> performs the unsigned ≤ operation of the C programming language.
Pseudo-instruction:	<code>cmpleu</code> is implemented with the <code>cmpgeu</code> instruction by swapping its rA and rB operands.

cmpleui

compare less than or equal unsigned immediate

Operation:	if ((unsigned) rA <= (unsigned) IMMED) then rB ← 1 else rB ← 0
Assembler Syntax:	<code>cmpleui rB, rA, IMMED</code>
Example:	<code>cmpleui r6, r7, 100</code>
Description:	Zero-extends the immediate value IMMED to 32 bits and compares it to the value of rA. If rA <= IMMED, then <code>cmpleui</code> stores 1 to rB; otherwise stores 0 to rB.
Usage:	<code>cmpleui</code> performs the unsigned <= operation of the C programming language. The maximum allowed value of IMMED is 65534. The minimum allowed value is 0.
Pseudo-instruction:	<code>cmpleui</code> is implemented using a <code>cmpltui</code> instruction with an IMM16 immediate value of IMMED + 1.

cmplt**compare less than signed**

Operation:	if ((signed) rA < (signed) rB) then rC ← 1 else rC ← 0
Assembler Syntax:	cmplt rC, rA, rB
Example:	cmplt r6, r7, r8
Description:	If rA < rB, then stores 1 to rC; otherwise stores 0 to rC.
Usage:	cmplt performs the signed < operation of the C programming language.
Exceptions:	None
Instruction Type:	R
Instruction Fields:	A = Register index of operand rA B = Register index of operand rB C = Register index of operand rC

31	30	29	28	27	26	25	24	23	22	21	20	19	18	17	16	15	14	13	12	11	10	9	8	7	6	5	4	3	2	1	0
A				B				C				0x10				0				0x3a											

cmplti

compare less than signed immediate

Operation: if ((signed) rA < (signed) σ (IMM16))
 then rB \leftarrow 1
 else rB \leftarrow 0

Assembler Syntax: `cmplti rB, rA, IMM16`

Example: `cmplti r6, r7, 100`

Description: Sign-extends the 16-bit immediate value IMM16 to 32 bits and compares it to the value of rA. If $rA < \sigma(\text{IMM16})$, then `cmplti` stores 1 to rB; otherwise stores 0 to rB.

Usage: `cmplti` performs the signed < operation of the C programming language.

Exceptions: None

Instruction Type: I

Instruction Fields: A = Register index of operand rA
 B = Register index of operand rB
 IMM16 = 16-bit signed immediate value

31	30	29	28	27	26	25	24	23	22	21	20	19	18	17	16	15	14	13	12	11	10	9	8	7	6	5	4	3	2	1	0
A				B				IMM16												0x10											

cmpltu**compare less than unsigned**

Operation:	if ((unsigned) rA < (unsigned) rB) then rC ← 1 else rC ← 0
Assembler Syntax:	cmpltu rC, rA, rB
Example:	cmpltu r6, r7, r8
Description:	If rA < rB, then stores 1 to rC; otherwise stores 0 to rC.
Usage:	cmpltu performs the unsigned < operation of the C programming language.
Exceptions:	None
Instruction Type:	R
Instruction Fields:	A = Register index of operand rA B = Register index of operand rB C = Register index of operand rC

31	30	29	28	27	26	25	24	23	22	21	20	19	18	17	16	15	14	13	12	11	10	9	8	7	6	5	4	3	2	1	0
A				B				C				0x30				0		0x3a													

cmpltui

compare less than unsigned immediate

Operation: if ((unsigned) rA < (unsigned) (0x0000 : IMM16))
 then rB ← 1
 else rB ← 0

Assembler Syntax: cmpltui rB, rA, IMM16

Example: cmpltui r6, r7, 100

Description: Zero-extends the 16-bit immediate value IMM16 to 32 bits and compares it to the value of rA. If rA < (0x0000 : IMM16), then cmpltui stores 1 to rB; otherwise stores 0 to rB.

Usage: cmpltui performs the unsigned < operation of the C programming language.

Exceptions: None

Instruction Type: I

Instruction Fields: A = Register index of operand rA
 B = Register index of operand rB
 IMM16 = 16-bit unsigned immediate value

31	30	29	28	27	26	25	24	23	22	21	20	19	18	17	16	15	14	13	12	11	10	9	8	7	6	5	4	3	2	1	0
A								B								IMM16								0x30							

cmpne**compare not equal**

Operation: if (rA != rB)
then rC ← 1
else rC ← 0

Assembler Syntax: cmpne rC, rA, rB

Example: cmpne r6, r7, r8

Description: If rA != rB, then stores 1 to rC; otherwise stores 0 to rC.

Usage: cmpne performs the != operation of the C programming language.

Exceptions: None

Instruction Type: R

Instruction Fields: A = Register index of operand rA
B = Register index of operand rB
C = Register index of operand rC

31	30	29	28	27	26	25	24	23	22	21	20	19	18	17	16	15	14	13	12	11	10	9	8	7	6	5	4	3	2	1	0
A				B				C				0x18				0				0x3a											

cmpnei

compare not equal immediate

Operation: if ($rA \neq \sigma(\text{IMM16})$)
 then $rB \leftarrow 1$
 else $rB \leftarrow 0$

Assembler Syntax: `cmpnei rB, rA, IMM16`

Example: `cmpnei r6, r7, 100`

Description: Sign-extends the 16-bit immediate value IMM16 to 32 bits and compares it to the value of rA. If $rA \neq \sigma(\text{IMM16})$, then `cmpnei` stores 1 to rB; otherwise stores 0 to rB.

Usage: `cmpnei` performs the `!=` operation of the C programming language.

Exceptions: None

Instruction Type: I

Instruction Fields: A = Register index of operand rA
 B = Register index of operand rB
 IMM16 = 16-bit signed immediate value

31	30	29	28	27	26	25	24	23	22	21	20	19	18	17	16	15	14	13	12	11	10	9	8	7	6	5	4	3	2	1	0
A				B				IMM16												0x18											

custom**custom instruction**

Operation:	if $c == 1$ then $rC \leftarrow f_N(rA, rB, A, B, C)$ else $\emptyset \leftarrow f_N(rA, rB, A, B, C)$
Assembler Syntax:	<code>custom N, xC, xA, xB</code> Where xA means either general purpose register rA, or custom register cA.
Example:	<code>custom 0, c6, r7, r8</code>
Description:	The <code>custom</code> opcode provides access to up to 256 custom instructions allowed by the Nios II architecture. The function implemented by a custom instruction is user-defined and is specified at system generation time. The 8-bit immediate N field specifies which custom instruction to use. Custom instructions can use up to two parameters, xA and xB, and can optionally write the result to a register xC.
Usage:	To access a custom register inside the custom instruction logic, clear the bit <code>readra</code> , <code>readrb</code> , or <code>writerc</code> that corresponds to the register field. In assembler syntax, the notation <code>cN</code> refers to register N in the custom register file and causes the assembler to clear the <code>c</code> bit of the opcode. For example, <code>custom 0, c3, r5, r0</code> performs custom instruction 0, operating on general-purpose registers r5 and r0, and stores the result in custom register 3.
Exceptions:	None
Instruction Type:	R
Instruction Fields:	A = Register index of operand A B = Register index of operand B C = Register index of operand C <code>readra</code> = 1 if instruction uses rA, 0 otherwise <code>readrb</code> = 1 if instruction uses rB, 0 otherwise <code>writerc</code> = 1 if instruction provides result for rC, 0 otherwise N = 8-bit number that selects instruction

31	30	29	28	27	26	25	24	23	22	21	20	19	18	17	16	15	14	13	12	11	10	9	8	7	6	5	4	3	2	1	0
A				B				C				ra	rb	rc	N				0x32												

div

divide

Operation: $rC \leftarrow rA \div rB$

Assembler Syntax: `div rC, rA, rB`

Example: `div r6, r7, r8`

Description: Treating *rA* and *rB* as signed integers, this instruction divides *rA* by *rB* and then stores the integer portion of the resulting quotient to *rC*. After attempted division by zero, the value of *rC* is undefined. There is no divide-by-zero exception. After dividing -2147483648 by -1 , the value of *rC* is undefined (the number $+2147483648$ is not representable in 32 bits). There is no overflow exception.

Nios II processors that do not implement the `div` instruction cause an unimplemented-instruction exception.

Usage: Remainder of Division:

If the result of the division is defined, then the remainder can be computed in *rD* using the following instruction sequence:

```
div rC, rA, rB      ; The original div operation
mul rD, rC, rB
sub rD, rA, rD      ; rD = remainder
```

Exceptions: Division error
 Unimplemented instruction

Instruction Type: R

Instruction Fields: A = Register index of operand *rA*
 B = Register index of operand *rB*
 C = Register index of operand *rC*

31	30	29	28	27	26	25	24	23	22	21	20	19	18	17	16	15	14	13	12	11	10	9	8	7	6	5	4	3	2	1	0
A				B				C				0x25				0				0x3a											

divu**divide unsigned****Operation:** $rC \leftarrow rA \div rB$ **Assembler Syntax:** `divu rC, rA, rB`**Example:** `divu r6, r7, r8`**Description:** Treating *rA* and *rB* as unsigned integers, this instruction divides *rA* by *rB* and then stores the integer portion of the resulting quotient to *rC*. After attempted division by zero, the value of *rC* is undefined. There is no divide-by-zero exception.Nios II processors that do not implement the `divu` instruction cause an unimplemented-instruction exception.**Usage:** Remainder of Division:If the result of the division is defined, then the remainder can be computed in *rD* using the following instruction sequence:

```
divu rC, rA, rB ; The original divu operation
mul rD, rC, rB
sub rD, rA, rD ; rD = remainder
```

Exceptions: Division error
Unimplemented instruction**Instruction Type:** R**Instruction Fields:** A = Register index of operand *rA*
B = Register index of operand *rB*
C = Register index of operand *rC*

31	30	29	28	27	26	25	24	23	22	21	20	19	18	17	16	15	14	13	12	11	10	9	8	7	6	5	4	3	2	1	0				
A								B								C								0x24				0				0x3a			

eret

exception return

Operation:	$status \leftarrow estatus$ $PC \leftarrow ea$
Assembler Syntax:	eret
Example:	eret
Description:	Copies the value of <i>estatus</i> into the <i>status</i> register, and transfers execution to the address in <i>ea</i> .
Usage:	Use <i>eret</i> to return from traps, external interrupts, and other exception-handling routines. Note that before returning from hardware interrupt exceptions, the exception handler must adjust the <i>ea</i> register.
Exceptions:	Misaligned destination address Supervisor-only instruction
Instruction Type:	R
Instruction Fields:	None

31	30	29	28	27	26	25	24	23	22	21	20	19	18	17	16	15	14	13	12	11	10	9	8	7	6	5	4	3	2	1	0
0x1d				0x1e				0				0x01				0				0x3a											

flushd**flush data cache line**

Operation:	Flushes the data cache line associated with address $rA + \sigma$ (IMM16).
Assembler Syntax:	<code>flushd IMM16 (rA)</code>
Example:	<code>flushd -100 (r6)</code>
Description:	<p>If the Nios II processor implements a direct mapped data cache, <code>flushd</code> writes the data cache line that is mapped to the specified address back to memory if the line is dirty, and then clears the data cache line. Unlike <code>flushda</code>, <code>flushd</code> writes the dirty data back to memory even when the addressed data is not currently in the cache. This process comprises the following steps:</p> <ul style="list-style-type: none"> ■ Compute the effective address specified by the sum of <code>rA</code> and the signed 16-bit immediate value. ■ Identify the data cache line associated with the computed effective address. Each data cache effective address comprises a <code>tag</code> field and a <code>line</code> field. When identifying the data cache line, <code>flushd</code> ignores the <code>tag</code> field and only uses the <code>line</code> field to select the data cache line to clear. ■ Skip comparing the cache line tag with the effective address to determine if the addressed data is currently cached. Because <code>flushd</code> ignores the cache line tag, <code>flushd</code> flushes the cache line regardless of whether the specified data location is currently cached. ■ If the data cache line is dirty, write the line back to memory. A cache line is dirty when one or more words of the cache line have been modified by the processor, but have not yet been written to memory. ■ Clear the valid bit for the line. <p>If the Nios II processor core does not have a data cache, the <code>flushd</code> instruction performs no operation.</p>
Usage:	<p>Use <code>flushd</code> to write dirty lines back to memory even if the addressed memory location is not in the cache, and then flush the cache line. By contrast, refer to “flushda flush data cache address” on page 8-51, “initd initialize data cache line” on page 8-54, and “initda initialize data cache address” on page 8-55 for other cache-clearing options.</p> <p>For more information on data cache, refer to the Cache and Tightly Coupled Memory chapter of the <i>Nios II Software Developer's Handbook</i>.</p>
Exceptions:	None
Instruction Type:	I
Instruction Fields:	<p>A = Register index of operand <code>rA</code></p> <p>IMM16 = 16-bit signed immediate value</p>

31	30	29	28	27	26	25	24	23	22	21	20	19	18	17	16	15	14	13	12	11	10	9	8	7	6	5	4	3	2	1	0
A					0		IMM16											0x3b													

flushda

flush data cache address

Operation:	Flushes the data cache line currently caching address $rA + \sigma$ (IMM16)
Assembler Syntax:	<code>flushda IMM16 (rA)</code>
Example:	<code>flushda -100 (r6)</code>
Description:	<p>If the Nios II processor implements a direct mapped data cache, <code>flushda</code> writes the data cache line that is mapped to the specified address back to memory if the line is dirty, and then clears the data cache line. Unlike <code>flushd</code>, <code>flushda</code> writes the dirty data back to memory only when the addressed data is currently in the cache. This process comprises the following steps:</p> <ul style="list-style-type: none"> ■ Compute the effective address specified by the sum of <code>rA</code> and the signed 16-bit immediate value. ■ Identify the data cache line associated with the computed effective address. Each data cache effective address comprises a <code>tag</code> field and a <code>line</code> field. When identifying the line, <code>flushda</code> uses both the <code>tag</code> field and the <code>line</code> field. ■ Compare the cache line tag with the effective address to determine if the addressed data is currently cached. If the <code>tag</code> fields do not match, the effective address is not currently cached, so the instruction does nothing. ■ If the data cache line is dirty and the <code>tag</code> fields match, write the dirty cache line back to memory. A cache line is dirty when one or more words of the cache line have been modified by the processor, but are not yet written to memory. ■ Clear the valid bit for the line. <p>If the Nios II processor core does not have a data cache, the <code>flushda</code> instruction performs no operation.</p>
Usage:	<p>Use <code>flushda</code> to write dirty lines back to memory only if the addressed memory location is currently in the cache, and then flush the cache line. By contrast, refer to “flushd flush data cache line” on page 8-50, “initd initialize data cache line” on page 8-54, and “initda initialize data cache address” on page 8-55 for other cache-clearing options.</p> <p>For more information on the Nios II data cache, refer to the <i>Cache and Tightly Coupled Memory</i> chapter of the <i>Nios II Software Developer's Handbook</i>.</p>
Exceptions:	<p>Supervisor-only data address</p> <p>Fast TLB miss (data)</p> <p>Double TLB miss (data)</p> <p>MPU region violation (data)</p>
Instruction Type:	I
Instruction Fields:	<p>A = Register index of operand <code>rA</code></p> <p>IMM16 = 16-bit signed immediate value</p>

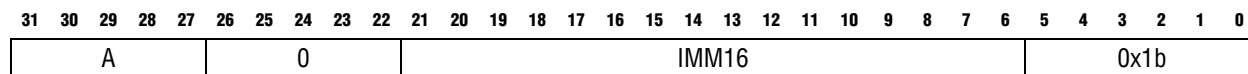

flushi**flush instruction cache line**

Operation:	Flushes the instruction-cache line associated with address rA.
Assembler Syntax:	<code>flushi rA</code>
Example:	<code>flushi r6</code>
Description:	<p>Ignoring the tag, <code>flushi</code> identifies the instruction-cache line associated with the byte address in rA, and invalidates that line.</p> <p>If the Nios II processor core does not have an instruction cache, the <code>flushi</code> instruction performs no operation.</p> <p>For more information about the data cache, refer to the <i>Cache and Tightly Coupled Memory</i> chapter of the <i>Nios II Software Developer's Handbook</i>.</p>
Exceptions:	None
Instruction Type:	R
Instruction Fields:	A = Register index of operand rA

31	30	29	28	27	26	25	24	23	22	21	20	19	18	17	16	15	14	13	12	11	10	9	8	7	6	5	4	3	2	1	0
A				0				0				0x0c				0				0x3a											

flushp

flush pipeline

- Operation:** Flushes the processor pipeline of any pre-fetched instructions.
- Assembler Syntax:** `flushp`
- Example:** `flushp`
- Description:** Ensures that any instructions pre-fetched after the `flushp` instruction are removed from the pipeline.
- Usage:** Use `flushp` before transferring control to newly updated instruction memory.
- Exceptions:** None
- Instruction Type:** R
- Instruction Fields:** None

31	30	29	28	27	26	25	24	23	22	21	20	19	18	17	16	15	14	13	12	11	10	9	8	7	6	5	4	3	2	1	0
0				0				0				0x04				0				0x3a											

initd**initialize data cache line**

Operation:	Initializes the data cache line associated with address $rA + \sigma$ (IMM16).
Assembler Syntax:	<code>initd IMM16(rA)</code>
Example:	<code>initd 0(r6)</code>
Description:	<p>If the Nios II processor implements a direct mapped data cache, <code>initd</code> clears the data cache line without checking for (or writing) a dirty data cache line that is mapped to the specified address back to memory. Unlike <code>initda</code>, <code>initd</code> clears the cache line regardless of whether the addressed data is currently cached. This process comprises the following steps:</p> <ul style="list-style-type: none"> ■ Compute the effective address specified by the sum of <code>rA</code> and the signed 16-bit immediate value. ■ Identify the data cache line associated with the computed effective address. Each data cache effective address comprises a <code>tag</code> field and a <code>line</code> field. When identifying the line, <code>initd</code> ignores the <code>tag</code> field and only uses the <code>line</code> field to select the data cache line to clear. ■ Skip comparing the cache line tag with the effective address to determine if the addressed data is currently cached. Because <code>initd</code> ignores the cache line tag, <code>initd</code> flushes the cache line regardless of whether the specified data location is currently cached. ■ Skip checking if the data cache line is dirty. Because <code>initd</code> skips the dirty cache line check, data that has been modified by the processor, but not yet written to memory is lost. ■ Clear the valid bit for the line. <p>If the Nios II processor core does not have a data cache, the <code>initd</code> instruction performs no operation.</p>
Usage:	<p>Use <code>initd</code> after processor reset and before accessing data memory to initialize the processor's data cache. Use <code>initd</code> with caution because it does not write back dirty data. By contrast, refer to “flushd flush data cache line” on page 8-50, “flushda flush data cache address” on page 8-51, and “initda initialize data cache address” on page 8-55 for other cache-clearing options. Altera recommends using <code>initd</code> only when the processor comes out of reset.</p> <p>For more information on data cache, refer to the Cache and Tightly Coupled Memory chapter of the <i>Nios II Software Developer's Handbook</i>.</p>
Exceptions:	Supervisor-only instruction
Instruction Type:	I
Instruction Fields:	<p>A = Register index of operand <code>rA</code></p> <p>IMM16 = 16-bit signed immediate value</p>

31	30	29	28	27	26	25	24	23	22	21	20	19	18	17	16	15	14	13	12	11	10	9	8	7	6	5	4	3	2	1	0
A					0					IMM16										0x33											

initda

initialize data cache address

Operation:	Initializes the data cache line currently caching address $rA + \sigma$ (IMM16)
Assembler Syntax:	<code>initda IMM16 (rA)</code>
Example:	<code>initda -100 (r6)</code>
Description:	<p>If the Nios II processor implements a direct mapped data cache, <code>initda</code> clears the data cache line without checking for (or writing) a dirty data cache line that is mapped to the specified address back to memory. Unlike <code>initd</code>, <code>initda</code> clears the cache line only when the addressed data is currently cached. This process comprises the following steps:</p> <ul style="list-style-type: none"> ■ Compute the effective address specified by the sum of <code>rA</code> and the signed 16-bit immediate value. ■ Identify the data cache line associated with the computed effective address. Each data cache effective address comprises a <code>tag</code> field and a <code>line</code> field. When identifying the line, <code>initda</code> uses both the <code>tag</code> field and the <code>line</code> field. ■ Compare the cache line tag with the effective address to determine if the addressed data is currently cached. If the <code>tag</code> fields do not match, the effective address is not currently cached, so the instruction does nothing. ■ Skip checking if the data cache line is dirty. Because <code>initd</code> skips the dirty cache line check, data that has been modified by the processor, but not yet written to memory is lost. ■ Clear the valid bit for the line. <p>If the Nios II processor core does not have a data cache, the <code>initda</code> instruction performs no operation.</p>
Usage:	<p>Use <code>initda</code> to skip writing dirty lines back to memory and to flush the cache line only if the addressed memory location is currently in the cache. By contrast, refer to “flushd flush data cache line” on page 8-50, “flushda flush data cache address” on page 8-51, and “initd initialize data cache line” on page 8-54 for other cache-clearing options. Use <code>initda</code> with caution because it does not write back dirty data.</p> <p>For more information on the Nios II data cache, refer to the <i>Cache and Tightly Coupled Memory</i> chapter of the <i>Nios II Software Developer's Handbook</i>.</p>
Exceptions:	<p>Supervisor-only data address Fast TLB miss (data) Double TLB miss (data) MPU region violation (data) Unimplemented instruction</p>
Instruction Type:	I
Instruction Fields:	<p>A = Register index of operand <code>rA</code> IMM16 = 16-bit signed immediate value</p>

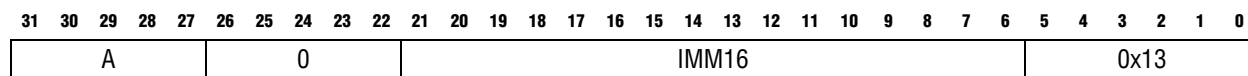

init**initialize instruction cache line**

Operation:	Initializes the instruction-cache line associated with address rA.
Assembler Syntax:	<code>init rA</code>
Example:	<code>init r6</code>
Description:	<p>Ignoring the tag, <code>init</code> identifies the instruction-cache line associated with the byte address in rA, and <code>init</code> invalidates that line.</p> <p>If the Nios II processor core does not have an instruction cache, the <code>init</code> instruction performs no operation.</p>
Usage:	<p>This instruction is used to initialize the processor's instruction cache. Immediately after processor reset, use <code>init</code> to invalidate each line of the instruction cache.</p> <p>For more information on instruction cache, refer to the <i>Cache and Tightly Coupled Memory</i> chapter of the <i>Nios II Software Developer's Handbook</i>.</p>
Exceptions:	Supervisor-only instruction
Instruction Type:	R
Instruction Fields:	A = Register index of operand rA

31	30	29	28	27	26	25	24	23	22	21	20	19	18	17	16	15	14	13	12	11	10	9	8	7	6	5	4	3	2	1	0	
A			0			0			0x29			0			0x3a																	

jmp

computed jump

Operation: PC ← rA
Assembler Syntax: jmp rA
Example: jmp r12
Description: Transfers execution to the address contained in register rA.

Usage: It is illegal to jump to the address contained in register r31. To return from subroutines called by `call` or `callr`, use `ret` instead of `jmp`.

Exceptions: Misaligned destination address

Instruction Type: R

Instruction Fields: A = Register index of operand rA

31	30	29	28	27	26	25	24	23	22	21	20	19	18	17	16	15	14	13	12	11	10	9	8	7	6	5	4	3	2	1	0	
A			0			0			0x0d			0			0x3a																	

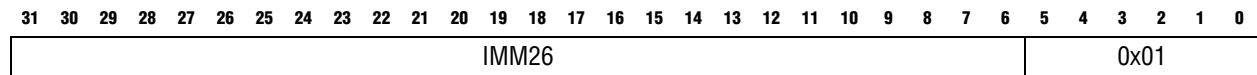
jmp**jump immediate****Operation:** $PC \leftarrow (PC_{31..28} : IMM26 \times 4)$ **Assembler Syntax:** `jmp label`**Example:** `jmp write_char`**Description:** Transfers execution to the instruction at address $(PC_{31..28} : IMM26 \times 4)$.**Usage:** `jmp` is a low-overhead local jump. `jmp` can transfer execution anywhere within the 256 MByte range determined by $PC_{31..28}$. The Nios II GNU linker does not automatically handle cases in which the address is out of this range.**Exceptions:** None**Instruction Type:** J**Instruction Fields:** IMM26 = 26-bit unsigned immediate value

ldb / ldbio

load byte from memory or I/O peripheral

Operation: $rB \leftarrow \sigma(\text{Mem8}[rA + \sigma(\text{IMM16})])$

Assembler Syntax: `ldb rB, byte_offset(rA)`
`ldbio rB, byte_offset(rA)`

Example: `ldb r6, 100(r5)`

Description: Computes the effective byte address specified by the sum of rA and the instruction's signed 16-bit immediate value. Loads register rB with the desired memory byte, sign extending the 8-bit value to 32 bits. In Nios II processor cores with a data cache, this instruction may retrieve the desired data from the cache instead of from memory.

Usage: Use the `ldbio` instruction for peripheral I/O. In processors with a data cache, `ldbio` bypasses the cache and is guaranteed to generate an Avalon-MM data transfer. In processors without a data cache, `ldbio` acts like `ldb`.
 For more information on data cache, refer to the *Cache and Tightly Coupled Memory* chapter of the *Nios II Software Developer's Handbook*.

Exceptions: Supervisor-only data address
 Misaligned data address
 TLB permission violation (read)
 Fast TLB miss (data)
 Double TLB miss (data)
 MPU region violation (data)

Instruction Type: I

Instruction Fields: A = Register index of operand rA
 B = Register index of operand rB
 IMM16 = 16-bit signed immediate value

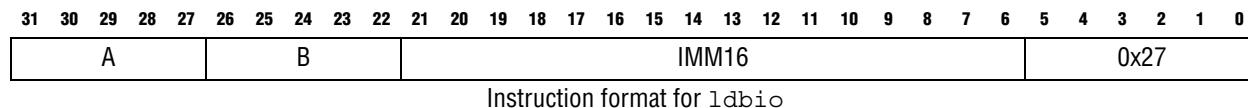
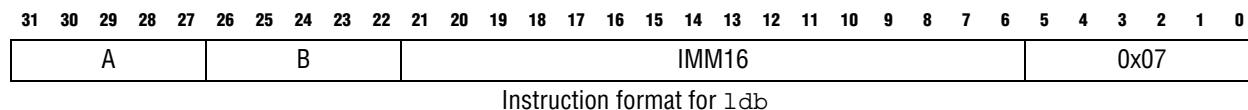

ldbu / ldbuio**load unsigned byte from memory or I/O peripheral**

Operation: $rB \leftarrow 0x000000 : \text{Mem8}[rA + \sigma(\text{IMM16})]$

Assembler Syntax:
`ldbu rB, byte_offset(rA)`
`ldbuio rB, byte_offset(rA)`

Example: `ldbu r6, 100(r5)`

Description: Computes the effective byte address specified by the sum of rA and the instruction's signed 16-bit immediate value. Loads register rB with the desired memory byte, zero extending the 8-bit value to 32 bits.

Usage: In processors with a data cache, this instruction may retrieve the desired data from the cache instead of from memory. Use the `ldbuio` instruction for peripheral I/O. In processors with a data cache, `ldbuio` bypasses the cache and is guaranteed to generate an Avalon-MM data transfer. In processors without a data cache, `ldbuio` acts like `ldbu`.

For more information on data cache, refer to the [Cache and Tightly Coupled Memory](#) chapter of the *Nios II Software Developer's Handbook*.

Exceptions:

- Supervisor-only data address
- Misaligned data address
- TLB permission violation (read)
- Fast TLB miss (data)
- Double TLB miss (data)
- MPU region violation (data)

Instruction Type: I

Instruction Fields:
 A = Register index of operand rA
 B = Register index of operand rB
 IMM16 = 16-bit signed immediate value

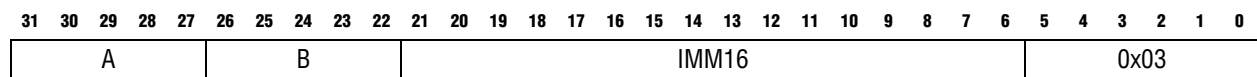
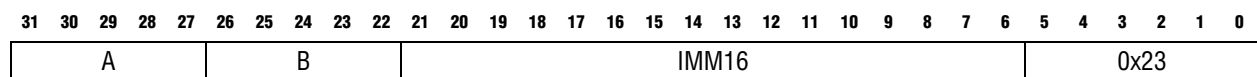
Instruction format for `ldbu`Instruction format for `ldbuio`

ldh / ldhio

load halfword from memory or I/O peripheral

Operation: $rB \leftarrow \sigma(\text{Mem16}[rA + \sigma(\text{IMM16})])$

Assembler Syntax:
`ldh rB, byte_offset(rA)`
`ldhio rB, byte_offset(rA)`

Example: `ldh r6, 100(r5)`

Description: Computes the effective byte address specified by the sum of rA and the instruction's signed 16-bit immediate value. Loads register rB with the memory halfword located at the effective byte address, sign extending the 16-bit value to 32 bits. The effective byte address must be halfword aligned. If the byte address is not a multiple of 2, the operation is undefined.

Usage: In processors with a data cache, this instruction may retrieve the desired data from the cache instead of from memory. Use the `ldhio` instruction for peripheral I/O. In processors with a data cache, `ldhio` bypasses the cache and is guaranteed to generate an Avalon-MM data transfer. In processors without a data cache, `ldhio` acts like `ldh`.
 For more information on data cache, refer to the *Cache and Tightly Coupled Memory* chapter of the *Nios II Software Developer's Handbook*.

- Exceptions:**
- Supervisor-only data address
 - Misaligned data address
 - TLB permission violation (read)
 - Fast TLB miss (data)
 - Double TLB miss (data)
 - MPU region violation (data)

Instruction Type: I

Instruction Fields:
 A = Register index of operand rA
 B = Register index of operand rB
 IMM16 = 16-bit signed immediate value

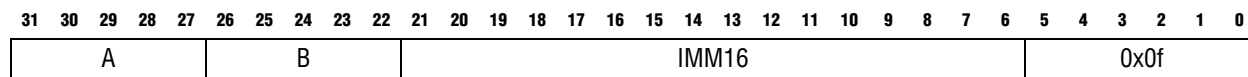

Instruction format for `ldh`

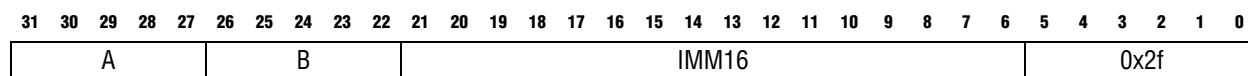

Instruction format for `ldhio`

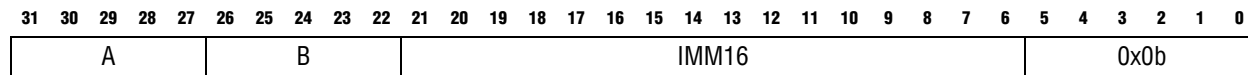
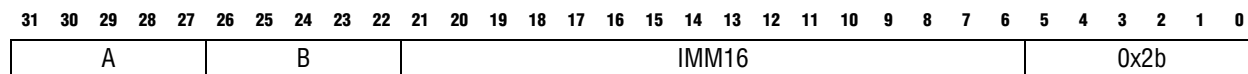
ldhu / ldhuio**load unsigned halfword from memory or I/O peripheral****Operation:** $rB \leftarrow 0x0000 : \text{Mem16}[rA + \sigma(\text{IMM16})]$ **Assembler Syntax:**
`ldhu rB, byte_offset(rA)`
`ldhuio rB, byte_offset(rA)`**Example:** `ldhu r6, 100(r5)`**Description:** Computes the effective byte address specified by the sum of rA and the instruction's signed 16-bit immediate value. Loads register rB with the memory halfword located at the effective byte address, zero extending the 16-bit value to 32 bits. The effective byte address must be halfword aligned. If the byte address is not a multiple of 2, the operation is undefined.**Usage:** In processors with a data cache, this instruction may retrieve the desired data from the cache instead of from memory. Use the `ldhuio` instruction for peripheral I/O. In processors with a data cache, `ldhuio` bypasses the cache and is guaranteed to generate an Avalon-MM data transfer. In processors without a data cache, `ldhuio` acts like `ldhu`.For more information on data cache, refer to the *Cache and Tightly Coupled Memory* chapter of the *Nios II Software Developer's Handbook*.**Exceptions:**
Supervisor-only data address
Misaligned data address
TLB permission violation (read)
Fast TLB miss (data)
Double TLB miss (data)
MPU region violation (data)**Instruction Type:** I**Instruction Fields:**
A = Register index of operand rA
B = Register index of operand rB
IMM16 = 16-bit signed immediate valueInstruction format for `ldhu`Instruction format for `ldhuio`

ldw / ldwio

load 32-bit word from memory or I/O peripheral

Operation: $rB \leftarrow \text{Mem32}[rA + \sigma(\text{IMM16})]$

Assembler Syntax:
`ldw rB, byte_offset(rA)`
`ldwio rB, byte_offset(rA)`

Example: `ldw r6, 100(r5)`

Description: Computes the effective byte address specified by the sum of rA and the instruction's signed 16-bit immediate value. Loads register rB with the memory word located at the effective byte address. The effective byte address must be word aligned. If the byte address is not a multiple of 4, the operation is undefined.

Usage: In processors with a data cache, this instruction may retrieve the desired data from the cache instead of from memory. Use the `ldwio` instruction for peripheral I/O. In processors with a data cache, `ldwio` bypasses the cache and memory. Use the `ldwio` instruction for peripheral I/O. In processors with a data cache, `ldwio` bypasses the cache and is guaranteed to generate an Avalon-MM data transfer. In processors without a data cache, `ldwio` acts like `ldw`.
 For more information on data cache, refer to the *Cache and Tightly Coupled Memory* chapter of the *Nios II Software Developer's Handbook*.

Exceptions: Supervisor-only data address
 Misaligned data address
 TLB permission violation (read)
 Fast TLB miss (data)
 Double TLB miss (data)
 MPU region violation (data)

Instruction Type: I

Instruction Fields: A = Register index of operand rA
 B = Register index of operand rB
 IMM16 = 16-bit signed immediate value

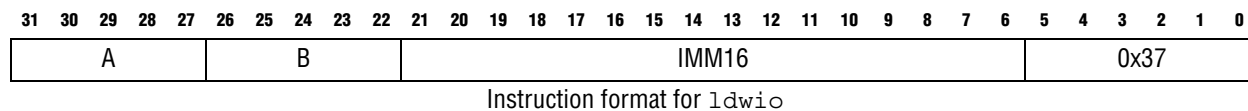
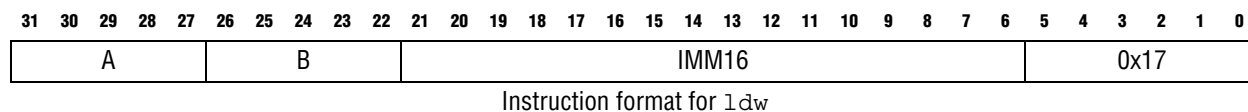

mov**move register to register**

Operation:	$rC \leftarrow rA$
Assembler Syntax:	<code>mov rC, rA</code>
Example:	<code>mov r6, r7</code>
Description:	Moves the contents of rA to rC.
Pseudo-instruction:	<code>mov</code> is implemented as <code>add rC, rA, r0</code> .

movhi

move immediate into high halfword

Operation: $rB \leftarrow (\text{IMMED} : 0x0000)$

Assembler Syntax: `movhi rB, IMMED`

Example: `movhi r6, 0x8000`

Description: Writes the immediate value IMMED into the high halfword of rB, and clears the lower halfword of rB to 0x0000.

Usage: The maximum allowed value of IMMED is 65535. The minimum allowed value is 0. To load a 32-bit constant into a register, first load the upper 16 bits using a `movhi` pseudo-instruction. The `%hi()` macro can be used to extract the upper 16 bits of a constant or a label. Then, load the lower 16 bits with an `ori` instruction. The `%lo()` macro can be used to extract the lower 16 bits of a constant or label as shown below.

```
movhi rB, %hi(value)
ori rB, rB, %lo(value)
```

An alternative method to load a 32-bit constant into a register uses the `%hiadj()` macro and the `addi` instruction as shown below.

```
movhi rB, %hiadj(value)
addi rB, rB, %lo(value)
```

Pseudo-instruction: `movhi` is implemented as `orhi rB, r0, IMMED`.

movi**move signed immediate into word**

Operation:	$rB \leftarrow \sigma(\text{IMMED})$
Assembler Syntax:	<code>movi rB, IMMED</code>
Example:	<code>movi r6, -30</code>
Description:	Sign-extends the immediate value IMMED to 32 bits and writes it to rB.
Usage:	The maximum allowed value of IMMED is 32767. The minimum allowed value is -32768. To load a 32-bit constant into a register, refer to the <code>movhi</code> instruction.
Pseudo-instruction:	<code>movi</code> is implemented as <code>addi rB, r0, IMMED</code> .

movia

move immediate address into word

Operation:	$rB \leftarrow \text{label}$
Assembler Syntax:	<code>movia rB, label</code>
Example:	<code>movia r6, function_address</code>
Description:	Writes the address of label to rB.
Pseudo-instruction:	movia is implemented as: <code>orhi rB, r0, %hiadj(label)</code> <code>addi rB, rB, %lo(label)</code>

movui**move unsigned immediate into word**

Operation:	$rB \leftarrow (0x0000 : IMMED)$
Assembler Syntax:	<code>movui rB, IMMED</code>
Example:	<code>movui r6, 100</code>
Description:	Zero-extends the immediate value IMMED to 32 bits and writes it to rB.
Usage:	The maximum allowed value of IMMED is 65535. The minimum allowed value is 0. To load a 32-bit constant into a register, refer to the <code>movhi</code> instruction.
Pseudo-instruction:	<code>movui</code> is implemented as <code>ori rB, r0, IMMED</code> .

mul

multiply

Operation: $rC \leftarrow (rA \times rB)_{31..0}$

Assembler Syntax: `mul rC, rA, rB`

Example: `mul r6, r7, r8`

Description: Multiplies rA times rB and stores the 32 low-order bits of the product to rC. The result is the same whether the operands are treated as signed or unsigned integers.
 Nios II processors that do not implement the mul instruction cause an unimplemented-instruction exception.

Usage: **Carry Detection (unsigned operands):**
 Before or after the multiply operation, the carry out of the MSB of rC can be detected using the following instruction sequence:

```
mul rC, rA, rB          ; The mul operation (optional)
mulxuu rD, rA, rB      ; rD is non-zero if carry occurred
cmpne rD, rD, r0       ; rD is 1 if carry occurred, 0 if not
```

The mulxuu instruction writes a non-zero value into rD if the multiplication of unsigned numbers will generate a carry (unsigned overflow). If a 0/1 result is desired, follow the mulxuu with the cmpne instruction.

Overflow Detection (signed operands):
 After the multiply operation, overflow can be detected using the following instruction sequence:

```
mul rC, rA, rB          ; The original mul operation
cmlt rD, rC, r0         ; rD is non-zero if overflow
mulxss rE, rA, rB      ; rE is non-zero if overflow
add rD, rD, rE         ; rD is 1 if overflow, 0 if not
```

The cmlt-mulxss-add instruction sequence writes a non-zero value into rD if the product in rC cannot be represented in 32 bits (signed overflow). If a 0/1 result is desired, follow the instruction sequence with the cmpne instruction.

Exceptions: Unimplemented instruction

Instruction Type: R

Instruction Fields:
 A = Register index of operand rA
 B = Register index of operand rB
 C = Register index of operand rC

31	30	29	28	27	26	25	24	23	22	21	20	19	18	17	16	15	14	13	12	11	10	9	8	7	6	5	4	3	2	1	0
A				B				C				0x27				0				0x3a											

mul**multiply immediate**

Operation: $rB \leftarrow (rA \times \alpha(\text{IMM16}))_{31..0}$

Assembler Syntax: `mul rB, rA, IMM16`

Example: `mul r6, r7, -100`

Description: Sign-extends the 16-bit immediate value IMM16 to 32 bits and multiplies it by the value of rA. Stores the 32 low-order bits of the product to rB. The result is independent of whether rA is treated as a signed or unsigned number.

Nios II processors that do not implement the `mul` instruction cause an unimplemented-instruction exception.

Carry Detection and Overflow Detection:

For a discussion of carry and overflow detection, refer to the `mul` instruction.

Exceptions: Unimplemented instruction

Instruction Type: I

Instruction Fields:
 A = Register index of operand rA
 B = Register index of operand rB
 IMM16 = 16-bit signed immediate value

31	30	29	28	27	26	25	24	23	22	21	20	19	18	17	16	15	14	13	12	11	10	9	8	7	6	5	4	3	2	1	0
A					B					IMM16												0x24									

mulxss

multiply extended signed/signed

Operation: $rC \leftarrow ((\text{signed}) rA) \times ((\text{signed}) rB)_{63..32}$

Assembler Syntax: `mulxss rC, rA, rB`

Example: `mulxss r6, r7, r8`

Description: Treating rA and rB as signed integers, `mulxss` multiplies rA times rB, and stores the 32 high-order bits of the product to rC.

Nios II processors that do not implement the `mulxss` instruction cause an unimplemented-instruction exception.

Usage: Use `mulxss` and `mul` to compute the full 64-bit product of two 32-bit signed integers. Furthermore, `mulxss` can be used as part of the calculation of a 128-bit product of two 64-bit signed integers. Given two 64-bit integers, each contained in a pair of 32-bit registers, (S1 : U1) and (S2 : U2), their 128-bit product is $(U1 \times U2) + ((S1 \times U2) \ll 32) + ((U1 \times S2) \ll 32) + ((S1 \times S2) \ll 64)$. The `mulxss` and `mul` instructions are used to calculate the 64-bit product $S1 \times S2$.

Exceptions: Unimplemented instruction

Instruction Type: R

Instruction Fields:
 A = Register index of operand rA
 B = Register index of operand rB
 C = Register index of operand rC

31	30	29	28	27	26	25	24	23	22	21	20	19	18	17	16	15	14	13	12	11	10	9	8	7	6	5	4	3	2	1	0
A				B				C				0x1f				0				0x3a											

mulxsu**multiply extended signed/unsigned**

Operation: $rC \leftarrow ((\text{signed}) rA) \times ((\text{unsigned}) rB)_{63..32}$

Assembler Syntax: `mulxsu rC, rA, rB`

Example: `mulxsu r6, r7, r8`

Description: Treating `rA` as a signed integer and `rB` as an unsigned integer, `mulxsu` multiplies `rA` times `rB`, and stores the 32 high-order bits of the product to `rC`.

Nios II processors that do not implement the `mulxsu` instruction cause an unimplemented-instruction exception.

Usage: `mulxsu` can be used as part of the calculation of a 128-bit product of two 64-bit signed integers. Given two 64-bit integers, each contained in a pair of 32-bit registers, (`S1 : U1`) and (`S2 : U2`), their 128-bit product is: $(U1 \times U2) + ((S1 \times U2) \ll 32) + ((U1 \times S2) \ll 32) + ((S1 \times S2) \ll 64)$. The `mulxsu` and `mul` instructions are used to calculate the two 64-bit products $S1 \times U2$ and $U1 \times S2$.

Exceptions: Unimplemented instruction

Instruction Type: R

Instruction Fields:
 A = Register index of operand `rA`
 B = Register index of operand `rB`
 C = Register index of operand `rC`

31	30	29	28	27	26	25	24	23	22	21	20	19	18	17	16	15	14	13	12	11	10	9	8	7	6	5	4	3	2	1	0
A				B				C				0x17				0				0x3a											

mulxuu

multiply extended unsigned/unsigned

- Operation:** $rC \leftarrow ((\text{unsigned}) rA) \times ((\text{unsigned}) rB))_{63..32}$
- Assembler Syntax:** `mulxuu rC, rA, rB`
- Example:** `mulxuu r6, r7, r8`
- Description:** Treating rA and rB as unsigned integers, `mulxuu` multiplies rA times rB and stores the 32 high-order bits of the product to rC.

Nios II processors that do not implement the `mulxuu` instruction cause an unimplemented-instruction exception.

- Usage:** Use `mulxuu` and `mul` to compute the 64-bit product of two 32-bit unsigned integers. Furthermore, `mulxuu` can be used as part of the calculation of a 128-bit product of two 64-bit signed integers. Given two 64-bit signed integers, each contained in a pair of 32-bit registers, (S1 : U1) and (S2 : U2), their 128-bit product is $(U1 \times U2) + ((S1 \times U2) \ll 32) + ((U1 \times S2) \ll 32) + ((S1 \times S2) \ll 64)$. The `mulxuu` and `mul` instructions are used to calculate the 64-bit product $U1 \times U2$.
- `mulxuu` also can be used as part of the calculation of a 128-bit product of two 64-bit unsigned integers. Given two 64-bit unsigned integers, each contained in a pair of 32-bit registers, (T1 : U1) and (T2 : U2), their 128-bit product is $(U1 \times U2) + ((U1 \times T2) \ll 32) + ((T1 \times U2) \ll 32) + ((T1 \times T2) \ll 64)$. The `mulxuu` and `mul` instructions are used to calculate the four 64-bit products $U1 \times U2$, $U1 \times T2$, $T1 \times U2$, and $T1 \times T2$.

- Exceptions:** Unimplemented instruction

- Instruction Type:** R

- Instruction Fields:** A = Register index of operand rA
 B = Register index of operand rB
 C = Register index of operand rC

31	30	29	28	27	26	25	24	23	22	21	20	19	18	17	16	15	14	13	12	11	10	9	8	7	6	5	4	3	2	1	0
A				B				C				0x07				0				0x3a											

nextpc**get address of following instruction****Operation:** $rC \leftarrow PC + 4$ **Assembler Syntax:** `nextpc rC`**Example:** `nextpc r6`**Description:** Stores the address of the next instruction to register rC.**Usage:** A relocatable code fragment can use `nextpc` to calculate the address of its data segment. `nextpc` is the only way to access the PC directly.**Exceptions:** None**Instruction Type:** R**Instruction Fields:** C = Register index of operand rC

31	30	29	28	27	26	25	24	23	22	21	20	19	18	17	16	15	14	13	12	11	10	9	8	7	6	5	4	3	2	1	0
0				0				C				0x1c				0				0x3a											

nop

no operation

Operation:	None
Assembler Syntax:	<code>nop</code>
Example:	<code>nop</code>
Description:	<code>nop</code> does nothing.
Pseudo-instruction:	<code>nop</code> is implemented as <code>add r0, r0, r0</code> .

nor**bitwise logical nor**

Operation:	$rC \leftarrow \sim(rA \mid rB)$
Assembler Syntax:	<code>nor rC, rA, rB</code>
Example:	<code>nor r6, r7, r8</code>
Description:	Calculates the bitwise logical NOR of rA and rB and stores the result in rC.
Exceptions:	None
Instruction Type:	R
Instruction Fields:	A = Register index of operand rA B = Register index of operand rB C = Register index of operand rC

31	30	29	28	27	26	25	24	23	22	21	20	19	18	17	16	15	14	13	12	11	10	9	8	7	6	5	4	3	2	1	0
A				B				C				0x06				0				0x3a											

or

bitwise logical or

Operation: $rC \leftarrow rA \mid rB$

Assembler Syntax: `or rC, rA, rB`

Example: `or r6, r7, r8`

Description: Calculates the bitwise logical OR of rA and rB and stores the result in rC.

Exceptions: None

Instruction Type: R

Instruction Fields:
 A = Register index of operand rA
 B = Register index of operand rB
 C = Register index of operand rC

31	30	29	28	27	26	25	24	23	22	21	20	19	18	17	16	15	14	13	12	11	10	9	8	7	6	5	4	3	2	1	0
A					B					C					0x16					0			0x3a								

orhi**bitwise logical or immediate into high halfword****Operation:** $rB \leftarrow rA \mid (\text{IMM16} : 0x0000)$ **Assembler Syntax:** `orhi rB, rA, IMM16`**Example:** `orhi r6, r7, 100`**Description:** Calculates the bitwise logical OR of rA and (IMM16 : 0x0000) and stores the result in rB.**Exceptions:** None**Instruction Type:** I**Instruction Fields:**
A = Register index of operand rA
B = Register index of operand rB
IMM16 = 16-bit signed immediate value

31	30	29	28	27	26	25	24	23	22	21	20	19	18	17	16	15	14	13	12	11	10	9	8	7	6	5	4	3	2	1	0
A				B				IMM16												0x34											

ori

bitwise logical or immediate

- Operation:** $rB \leftarrow rA \mid (0x0000 : IMM16)$
- Assembler Syntax:** `ori rB, rA, IMM16`
- Example:** `ori r6, r7, 100`
- Description:** Calculates the bitwise logical OR of rA and (0x0000 : IMM16) and stores the result in rB.
- Exceptions:** None
- Instruction Type:** I
- Instruction Fields:**
 A = Register index of operand rA
 B = Register index of operand rB
 IMM16 = 16-bit unsigned immediate value

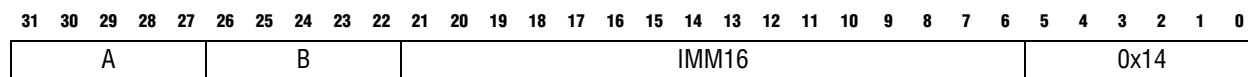

rdctl**read from control register**

Operation: $rC \leftarrow ctIN$

Assembler Syntax: `rdctl rC, ctIN`

Example: `rdctl r3, ct131`

Description: Reads the value contained in control register `ctIN` and writes it to register `rC`.

Exceptions: Supervisor-only instruction

Instruction Type: R

Instruction Fields: C = Register index of operand `rC`
N = Control register index of operand `ctIN`

31	30	29	28	27	26	25	24	23	22	21	20	19	18	17	16	15	14	13	12	11	10	9	8	7	6	5	4	3	2	1	0
0				0				C				0x26				N				0x3a											

ret

return from subroutine

Operation: $PC \leftarrow ra$
Assembler Syntax: `ret`
Example: `ret`
Description: Transfers execution to the address in `ra`.

Usage: Any subroutine called by `call` or `callr` must use `ret` to return.

Exceptions: Misaligned destination address

Instruction Type: R

Instruction Fields: None

31	30	29	28	27	26	25	24	23	22	21	20	19	18	17	16	15	14	13	12	11	10	9	8	7	6	5	4	3	2	1	0
0x1f				0				0				0x05				0				0x3a											

rol**rotate left****Operation:** $rC \leftarrow rA$ rotated left $rB_{4..0}$ bit positions**Assembler Syntax:** `rol rC, rA, rB`**Example:** `rol r6, r7, r8`**Description:** Rotates rA left by the number of bits specified in $rB_{4..0}$ and stores the result in rC . The bits that shift out of the register rotate into the least-significant bit positions. Bits 31–5 of rB are ignored.**Exceptions:** None**Instruction Type:** R**Instruction Fields:**
A = Register index of operand rA
B = Register index of operand rB
C = Register index of operand rC

31	30	29	28	27	26	25	24	23	22	21	20	19	18	17	16	15	14	13	12	11	10	9	8	7	6	5	4	3	2	1	0
A					B					C					0x03					0			0x3a								

rol

rotate left immediate

- Operation:** $rC \leftarrow rA$ rotated left IMM5 bit positions
- Assembler Syntax:** `rol rC, rA, IMM5`
- Example:** `rol r6, r7, 3`
- Description:** Rotates rA left by the number of bits specified in IMM5 and stores the result in rC. The bits that shift out of the register rotate into the least-significant bit positions.
- Usage:** In addition to the rotate-left operation, `rol` can be used to implement a rotate-right operation. Rotating left by $(32 - IMM5)$ bits is the equivalent of rotating right by IMM5 bits.
- Exceptions:** None
- Instruction Type:** R
- Instruction Fields:**
 A = Register index of operand rA
 C = Register index of operand rC
 IMM5 = 5-bit unsigned immediate value

31	30	29	28	27	26	25	24	23	22	21	20	19	18	17	16	15	14	13	12	11	10	9	8	7	6	5	4	3	2	1	0
A					0					C					0x02					IMM5					0x3a						

ror**rotate right**

Operation: $rC \leftarrow rA$ rotated right $rB_{4..0}$ bit positions

Assembler Syntax: `ror rC, rA, rB`

Example: `ror r6, r7, r8`

Description: Rotates rA right by the number of bits specified in $rB_{4..0}$ and stores the result in rC . The bits that shift out of the register rotate into the most-significant bit positions. Bits 31–5 of rB are ignored.

Exceptions: None

Instruction Type: R

Instruction Fields: A = Register index of operand rA
B = Register index of operand rB
C = Register index of operand rC

31	30	29	28	27	26	25	24	23	22	21	20	19	18	17	16	15	14	13	12	11	10	9	8	7	6	5	4	3	2	1	0
A					B					C					0x0b					0			0x3a								

sll

shift left logical

Operation: $rC \leftarrow rA \ll (rB_{4..0})$

Assembler Syntax: `sll rC, rA, rB`

Example: `sll r6, r7, r8`

Description: Shifts rA left by the number of bits specified in rB_{4..0} (inserting zeroes), and then stores the result in rC. `sll` performs the `<<` operation of the C programming language.

Exceptions: None

Instruction Type: R

Instruction Fields:
 A = Register index of operand rA
 B = Register index of operand rB
 C = Register index of operand rC

31	30	29	28	27	26	25	24	23	22	21	20	19	18	17	16	15	14	13	12	11	10	9	8	7	6	5	4	3	2	1	0
A				B				C				0x13				0				0x3a											

slli**shift left logical immediate****Operation:** $rC \leftarrow rA \ll IMM5$ **Assembler Syntax:** `slli rC, rA, IMM5`**Example:** `slli r6, r7, 3`**Description:** Shifts rA left by the number of bits specified in IMM5 (inserting zeroes), and then stores the result in rC.**Usage:** `slli` performs the `<<` operation of the C programming language.**Exceptions:** None**Instruction Type:** R**Instruction Fields:**
A = Register index of operand rA
C = Register index of operand rC
IMM5 = 5-bit unsigned immediate value

31	30	29	28	27	26	25	24	23	22	21	20	19	18	17	16	15	14	13	12	11	10	9	8	7	6	5	4	3	2	1	0
A				0				C				0x12				IMM5				0x3a											

sra

shift right arithmetic

Operation: $rC \leftarrow (\text{signed } rA \gg ((\text{unsigned}) rB_{4..0}))$

Assembler Syntax: `sra rC, rA, rB`

Example: `sra r6, r7, r8`

Description: Shifts rA right by the number of bits specified in rB_{4..0} (duplicating the sign bit), and then stores the result in rC. Bits 31–5 are ignored.

Usage: sra performs the signed >> operation of the C programming language.

Exceptions: None

Instruction Type: R

Instruction Fields:
 A = Register index of operand rA
 B = Register index of operand rB
 C = Register index of operand rC

31	30	29	28	27	26	25	24	23	22	21	20	19	18	17	16	15	14	13	12	11	10	9	8	7	6	5	4	3	2	1	0
A					B					C					0x3b					0			0x3a								

srai**shift right arithmetic immediate****Operation:** $rC \leftarrow (\text{signed } rA \gg (\text{unsigned } IMM5))$ **Assembler Syntax:** `srai rC, rA, IMM5`**Example:** `srai r6, r7, 3`**Description:** Shifts rA right by the number of bits specified in IMM5 (duplicating the sign bit), and then stores the result in rC.**Usage:** `srai` performs the signed `>>` operation of the C programming language.**Exceptions:** None**Instruction Type:** R**Instruction Fields:**
A = Register index of operand rA
C = Register index of operand rC
IMM5 = 5-bit unsigned immediate value

31	30	29	28	27	26	25	24	23	22	21	20	19	18	17	16	15	14	13	12	11	10	9	8	7	6	5	4	3	2	1	0
A					0					C					0x3a					IMM5					0x3a						

srl

shift right logical

Operation: $rC \leftarrow (\text{unsigned}) rA \gg ((\text{unsigned}) rB_{4..0})$

Assembler Syntax: `srl rC, rA, rB`

Example: `srl r6, r7, r8`

Description: Shifts rA right by the number of bits specified in rB_{4..0} (inserting zeroes), and then stores the result in rC. Bits 31–5 are ignored.

Usage: `srl` performs the unsigned `>>` operation of the C programming language.

Exceptions: None

Instruction Type: R

Instruction Fields:
 A = Register index of operand rA
 B = Register index of operand rB
 C = Register index of operand rC

31	30	29	28	27	26	25	24	23	22	21	20	19	18	17	16	15	14	13	12	11	10	9	8	7	6	5	4	3	2	1	0
A				B				C				0x1b				0				0x3a											

srli**shift right logical immediate****Operation:** $rC \leftarrow (\text{unsigned}) rA \gg ((\text{unsigned}) IMM5)$ **Assembler Syntax:** `srli rC, rA, IMM5`**Example:** `srli r6, r7, 3`**Description:** Shifts rA right by the number of bits specified in IMM5 (inserting zeroes), and then stores the result in rC.**Usage:** `srli` performs the unsigned `>>` operation of the C programming language.**Exceptions:** None**Instruction Type:** R**Instruction Fields:**
A = Register index of operand rA
C = Register index of operand rC
IMM5 = 5-bit unsigned immediate value

31	30	29	28	27	26	25	24	23	22	21	20	19	18	17	16	15	14	13	12	11	10	9	8	7	6	5	4	3	2	1	0
A				0				C				0x1a				IMM5				0x3a											

stb / stbio

store byte to memory or I/O peripheral

Operation: $\text{Mem8}[\text{rA} + \sigma(\text{IMM16})] \leftarrow \text{rB}_{7:0}$

Assembler Syntax: `stb rB, byte_offset(rA)`
`stbio rB, byte_offset(rA)`

Example: `stb r6, 100(r5)`

Description: Computes the effective byte address specified by the sum of rA and the instruction's signed 16-bit immediate value. Stores the low byte of rB to the memory byte specified by the effective address.

Usage: In processors with a data cache, this instruction may not generate an Avalon-MM bus cycle to non-cache data memory immediately. Use the `stbio` instruction for peripheral I/O. In processors with a data cache, `stbio` bypasses the cache and is guaranteed to generate an Avalon-MM data transfer. In processors without a data cache, `stbio` acts like `stb`.

Exceptions: Supervisor-only data address
 Misaligned data address
 TLB permission violation (write)
 Fast TLB miss (data)
 Double TLB miss (data)
 MPU region violation (data)

Instruction Type: I

Instruction Fields: A = Register index of operand rA
 B = Register index of operand rB
 IMM16 = 16-bit signed immediate value

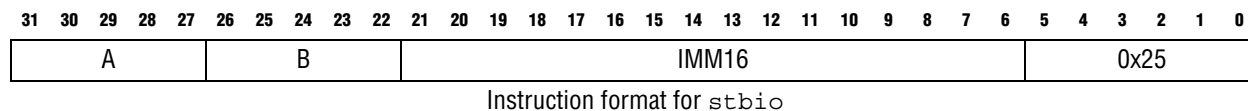
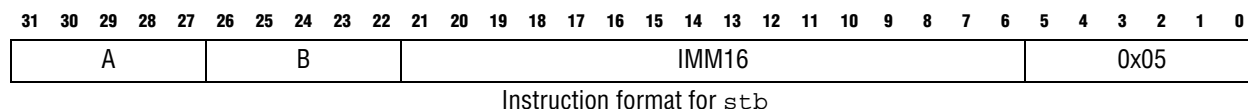

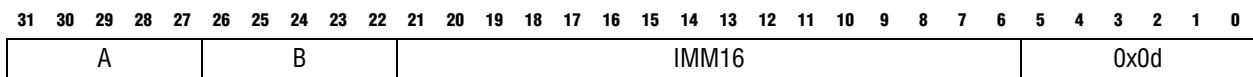
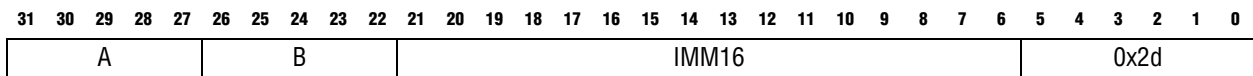
sth / sthio**store halfword to memory or I/O peripheral****Operation:** $\text{Mem16}[\text{rA} + \sigma(\text{IMM16})] \leftarrow \text{rB}_{15:0}$ **Assembler Syntax:**
`sth rB, byte_offset(rA)`
`sthio rB, byte_offset(rA)`**Example:** `sth r6, 100(r5)`**Description:** Computes the effective byte address specified by the sum of rA and the instruction's signed 16-bit immediate value. Stores the low halfword of rB to the memory location specified by the effective byte address. The effective byte address must be halfword aligned. If the byte address is not a multiple of 2, the operation is undefined.**Usage:** In processors with a data cache, this instruction may not generate an Avalon-MM data transfer immediately. Use the sthio instruction for peripheral I/O. In processors with a data cache, sthio bypasses the cache and is guaranteed to generate an Avalon-MM data transfer. In processors without a data cache, sthio acts like sth.**Exceptions:**
Supervisor-only data address
Misaligned data address
TLB permission violation (write)
Fast TLB miss (data)
Double TLB miss (data)
MPU region violation (data)**Instruction Type:** I**Instruction Fields:**
A = Register index of operand rA
B = Register index of operand rB
IMM16 = 16-bit signed immediate valueInstruction format for `sth`Instruction format for `sthio`

stw / stwio

store word to memory or I/O peripheral

- Operation:** $\text{Mem32}[\text{rA} + \sigma(\text{IMM16})] \leftarrow \text{rB}$
- Assembler Syntax:**
`stw rB, byte_offset(rA)`
`stwio rB, byte_offset(rA)`
- Example:** `stw r6, 100(r5)`
- Description:** Computes the effective byte address specified by the sum of rA and the instruction's signed 16-bit immediate value. Stores rB to the memory location specified by the effective byte address. The effective byte address must be word aligned. If the byte address is not a multiple of 4, the operation is undefined.
- Usage:** In processors with a data cache, this instruction may not generate an Avalon-MM data transfer immediately. Use the `stwio` instruction for peripheral I/O. In processors with a data cache, `stwio` bypasses the cache and is guaranteed to generate an Avalon-MM bus cycle. In processors without a data cache, `stwio` acts like `stw`.
- Exceptions:**
 Supervisor-only data address
 Misaligned data address
 TLB permission violation (write)
 Fast TLB miss (data)
 Double TLB miss (data)
 MPU region violation (data)
- Instruction Type:** I
- Instruction Fields:**
 A = Register index of operand rA
 B = Register index of operand rB
 IMM16 = 16-bit signed immediate value

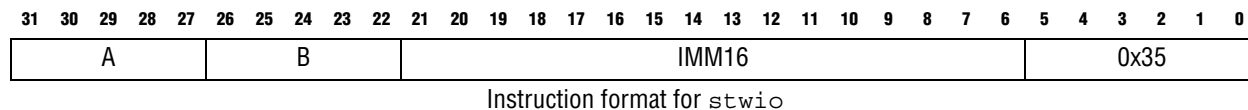
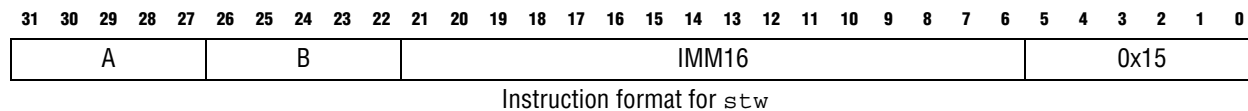

sub**subtract**

Operation: $rC \leftarrow rA - rB$

Assembler Syntax: `sub rC, rA, rB`

Example: `sub r6, r7, r8`

Description: Subtract rB from rA and store the result in rC.

Usage: **Carry Detection (unsigned operands):**

The carry bit indicates an unsigned overflow. Before or after a `sub` operation, a carry out of the MSB can be detected by checking whether the first operand is less than the second operand. The carry bit can be written to a register, or a conditional branch can be taken based on the carry condition. Both cases are shown below.

```
sub rC, rA, rB      ; The original sub operation (optional)
cmpltu rD, rA, rB  ; rD is written with the carry bit
sub rC, rA, rB      ; The original sub operation (optional)
bltu rA, rB, label ; Branch if carry was generated
```

Overflow Detection (signed operands):

Detect overflow of signed subtraction by comparing the sign of the difference that is written to rC with the signs of the operands. If rA and rB have different signs, and the sign of rC is different than the sign of rA, an overflow occurred. The overflow condition can control a conditional branch, as shown below.

```
sub rC, rA, rB      ; The original sub operation
xor rD, rA, rB      ; Compare signs of rA and rB
xor rE, rA, rC      ; Compare signs of rA and rC
and rD, rD, rE      ; Combine comparisons
blt rD, r0, label   ; Branch if overflow occurred
```

Exceptions: None

Instruction Type: R

Instruction Fields: A = Register index of operand rA
B = Register index of operand rB
C = Register index of operand rC

31	30	29	28	27	26	25	24	23	22	21	20	19	18	17	16	15	14	13	12	11	10	9	8	7	6	5	4	3	2	1	0				
A								B								C								0x39				0				0x3a			

subi

subtract immediate

Operation:	$rB \leftarrow rA - \sigma(\text{IMMED})$
Assembler Syntax:	<code>subi rB, rA, IMMED</code>
Example:	<code>subi r8, r8, 4</code>
Description:	Sign-extends the immediate value IMMED to 32 bits, subtracts it from the value of rA and then stores the result in rB.
Usage:	The maximum allowed value of IMMED is 32768. The minimum allowed value is -32767.
Pseudo-instruction:	<code>subi</code> is implemented as <code>addi rB, rA, -IMMED</code>

sync**memory synchronization**

Operation:	None
Assembler Syntax:	<code>sync</code>
Example:	<code>sync</code>
Description:	Forces all pending memory accesses to complete before allowing execution of subsequent instructions. In processor cores that support in-order memory accesses only, this instruction performs no operation.

Exceptions: None

Instruction Type: R

Instruction Fields: None

31	30	29	28	27	26	25	24	23	22	21	20	19	18	17	16	15	14	13	12	11	10	9	8	7	6	5	4	3	2	1	0
0				0				0				0x36				0				0x3a											

trap

trap

Operation: $estatus \leftarrow status$
 $PIE \leftarrow 0$
 $U \leftarrow 0$
 $ea \leftarrow PC + 4$
 $PC \leftarrow \text{exception handler address}$

Assembler Syntax: `trap`
`trap imm5`

Example: `trap`

Description: Saves the address of the next instruction in register `ea`, saves the contents of the `status` register in `estatus`, disables interrupts, and transfers execution to the exception handler. The address of the exception handler is specified at system generation time.

The 5-bit immediate field `imm5` is ignored by the processor, but it can be used by the debugger.

`trap` with no argument is the same as `trap 0`.

Usage: To return from the exception handler, execute an `eret` instruction.

Exceptions: Trap

Instruction Type: R

Instruction Fields: IMM5 = Type of breakpoint

31	30	29	28	27	26	25	24	23	22	21	20	19	18	17	16	15	14	13	12	11	10	9	8	7	6	5	4	3	2	1	0
0				0				0x1d				0x2d				IMM5				0x3a											

wrctl**write to control register**

Operation: $ctlN \leftarrow rA$

Assembler Syntax: `wrctl ctlN, rA`

Example: `wrctl ctl6, r3`

Description: Writes the value contained in register rA to the control register ctlN.

Exceptions: Supervisor-only instruction

Instruction Type: R

Instruction Fields: A = Register index of operand rA
N = Control register index of operand ctlN

31	30	29	28	27	26	25	24	23	22	21	20	19	18	17	16	15	14	13	12	11	10	9	8	7	6	5	4	3	2	1	0
A				0				0				0x2e				N				0x3a											

XOR

bitwise logical exclusive or

- Operation:** $rC \leftarrow rA \wedge rB$
- Assembler Syntax:** `xor rC, rA, rB`
- Example:** `xor r6, r7, r8`
- Description:** Calculates the bitwise logical exclusive XOR of rA and rB and stores the result in rC.
- Exceptions:** None
- Instruction Type:** R
- Instruction Fields:**
 A = Register index of operand rA
 B = Register index of operand rB
 C = Register index of operand rC

31	30	29	28	27	26	25	24	23	22	21	20	19	18	17	16	15	14	13	12	11	10	9	8	7	6	5	4	3	2	1	0
A				B				C				0x1e				0				0x3a											

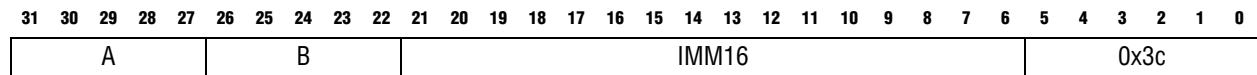
xorhi **bitwise logical exclusive or immediate into high halfword****Operation:** $rB \leftarrow rA \wedge (\text{IMM16} : 0x0000)$ **Assembler Syntax:** `xorhi rB, rA, IMM16`**Example:** `xorhi r6, r7, 100`**Description:** Calculates the bitwise logical exclusive XOR of rA and (IMM16 : 0x0000) and stores the result in rB.**Exceptions:** None**Instruction Type:** I**Instruction Fields:**
A = Register index of operand rA
B = Register index of operand rB
IMM16 = 16-bit unsigned immediate value

xori

bitwise logical exclusive or immediate

Operation: $rB \leftarrow rA \wedge (0x0000 : IMM16)$

Assembler Syntax: `xori rB, rA, IMM16`

Example: `xori r6, r7, 100`

Description: Calculates the bitwise logical exclusive OR of rA and (0x0000 : IMM16) and stores the result in rB.

Exceptions: None

Instruction Type: I

Instruction Fields:
 A = Register index of operand rA
 B = Register index of operand rB
 IMM16 = 16-bit unsigned immediate value

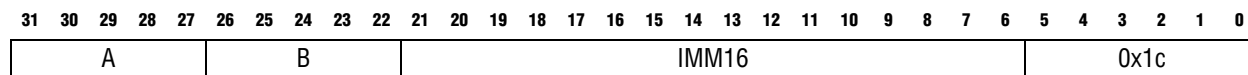

Referenced Documents

This chapter references the following documents:

- *Programming Model* chapter of the *Nios II Processor Reference Handbook*
- *Application Binary Interface* chapter of the *Nios II Processor Reference Handbook*
- *Cache and Tightly Coupled Memory* chapter of the *Nios II Software Developer's Handbook*

Document Revision History

Table 8-6 shows the revision history for this document.

Table 8-6. Document Revision History (Part 1 of 2)

Date & Document Version	Changes Made	Summary of Changes
March 2009 v9.0.0	Backward-compatible change to the <code>eret</code> instruction B field encoding.	—
November 2008 v8.1.0	Maintenance release.	—
May 2008 v8.0.0	Added an Exceptions section to all instructions.	Added MMU.
October 2007 v7.2.0	Added <code>jmp_i</code> instruction.	—
May 2007 v7.1.0	<ul style="list-style-type: none"> ■ Added table of contents to Introduction section. ■ Added Referenced Documents section. 	—
March 2007 v7.0.0	Maintenance release.	—
November 2006 v6.1.0	Maintenance release.	—
May 2006 v6.0.0	Maintenance release.	—
October 2005 v5.1.0	<ul style="list-style-type: none"> ■ Correction to the <code>blt</code> instruction. ■ Added U bit operation for <code>break</code> and <code>trap</code> instructions. 	—
July 2005 v5.0.1	<ul style="list-style-type: none"> ■ Added new <code>flushda</code> instruction. ■ Updated <code>flushd</code> instruction. ■ Instruction Opcode table updated with <code>flushda</code> instruction. 	—
May 2005 v5.0.0	Maintenance release.	—
December 2004 v1.2	<ul style="list-style-type: none"> ■ <code>break</code> instruction update. ■ <code>srl_i</code> instruction correction. 	—

Table 8-6. Document Revision History (Part 2 of 2)

Date & Document Version	Changes Made	Summary of Changes
September 2004 v1.1	Updates for Nios II 1.01 release.	—
May 2004 v1.0	Initial release.	—

How to Find Further Information

This handbook is one part of the complete Nios II processor documentation. The following references are also available.

- The *Nios II Software Developer's Handbook* describes the software development environment, and discusses application programming for the Nios II processor.
- The *Volume 5: Embedded Peripherals* of the *Quartus II Handbook* discusses Altera-provided peripherals and Nios II drivers which are included with the Quartus® II software.
- The Nios II integrated development environment (IDE) provides tutorials and complete reference for using the features of the graphical user interface. The help system is available after launching the Nios II IDE.
- Altera's on-line solutions database is an internet resource that offers solutions to frequently asked questions via an easy-to-use search engine. You can access the database from the [Knowledge Database](#) page of the Altera website.
- Altera application notes and tutorials offer step-by-step instructions on using the Nios II processor for a specific application or purpose. You can obtain these documents from the [Literature: Nios II Processor](#) page on the Altera website.

How to Contact Altera

For the most up-to-date information about Altera® products, refer to the following table.





Contact <i>(Note 1)</i>	Contact Method	Address
Technical support	Website	www.altera.com/support
Technical training	Website	www.altera.com/training
	Email	custrain@altera.com
Altera literature services	Email	literature@altera.com
Non-technical support (General) (Software Licensing)	Email	nacomp@altera.com
	Email	authorization@altera.com

Note:

(1) You can also contact your local Altera sales office or sales representative.

Typographic Conventions

The following table shows the typographic conventions that this document uses.

Visual Cue	Meaning
Bold Type with Initial Capital Letters	Indicates command names, dialog box titles, dialog box options, and other GUI labels. For example, Save As dialog box.
bold type	Indicates directory names, project names, disk drive names, file names, file name extensions, and software utility names. For example, qdesigns directory, d: drive, and chiptrip.gdf file.
<i>Italic Type with Initial Capital Letters</i>	Indicates document titles. For example, <i>AN 519: Stratix IV Design Guidelines</i> .
<i>Italic type</i>	Indicates variables. For example, $n + 1$. Variable names are enclosed in angle brackets (<>). For example, <file name> and <project name>.pdf file.
Initial Capital Letters	Indicates keyboard keys and menu names. For example, Delete key and Options menu.
"Subheading Title"	Quotation marks indicate references to sections within a document and titles of Quartus II Help topics. For example, "Typographic Conventions".
Courier type	Indicates signal, port, register, bit, block, and primitive names. For example, data1, tdi, and input. Active-low signals are denoted by suffix n. For example, resetn. Indicates command line commands and anything that must be typed exactly as it appears. For example, c:\qdesigns\tutorial\chiptrip.gdf. Also indicates sections of an actual file, such as a Quartus II report file, references to parts of files (for example, the AHDL keyword SUBDESIGN), and logic function names (for example, TRI).
1., 2., 3., and a., b., c., and so on.	Numbered steps indicate a list of items when the sequence of the items is important, such as the steps listed in a procedure.
■ ■	Bullets indicate a list of items when the sequence of the items is not important.
	The hand points to information that requires special attention.
 CAUTION	A caution calls attention to a condition or possible situation that can damage or destroy the product or your work.
 WARNING	A warning calls attention to a condition or possible situation that can cause you injury.
	The angled arrow instructs you to press the Enter key.
	The feet direct you to more information about a particular topic.