

# How to Make Smart Antenna Arrays

The Nallatech BenADIC card combines a 20-channel data acquisition system with Xilinx XtremeDSP technology and Virtex FPGAs for high-performance digital signal processing.

by Malachy Devlin, Ph.D.  
Chief Technology Officer  
Nallatech  
[m.devlin@nallatech.com](mailto:m.devlin@nallatech.com)

Wireless communication has created a continuing demand for increased bandwidth and better quality of service. With the ever-increasing number of mobile network subscribers, available capacity is becoming more of a premium.

“Smart” antenna arrays are one way to accommodate this increasing demand for bandwidth and quality. These antenna arrays provide numerous benefits to service providers. However, the processing requirements for smart antenna arrays are many orders of magnitude greater than those for single antenna implementations.

In this article, we will describe how smart antenna arrays work and present a new product from Nallatech™ that combines a 20-channel data acquisition system with an FPGA computing fabric for handling the high-performance digital signal processing (DSP) operations. We also show you how this combined product is integrated into a scalable system using Xilinx Internet Reconfigurable Logic (IRL™) technology for remote configuration and control of the system using Nallatech's field upgrade systems environment (FUSE™) software.

### Focus Power with Smart Antennas

Figure 1 shows a conventional antenna as omnidirectional. It radiates and receives information equally in all directions. This equal distribution leads to power being transmitted to, but not received by, the user. This wasted power becomes potential interference to other users or to other base stations in other cells. Interference and noise reduce the signal-to-noise ratio used by the detection and demodulation operations, resulting in poor signal quality.

To overcome the problems associated with omnidirectional arrays, smart antennas focus all transmitted power to the user and only "look" in the direction of the user for the received signal. This ensures that the user receives the optimum quality of service and maximum coverage for a base station. An intermediate step to this ideal is using directional antennas that divide the 360-degree coverage into sectors. As shown in Figure 2, four directional antennas can each cover approximately 90 degrees.

Instead of using individual antennas, we can create a smart antenna array and add further processing intelligence to the data received or transmitted with this array. Smart antenna arrays enable us to direct beams in specific directions through electronic or software control.

Two types of smart antenna arrays are switched-beam arrays and adaptive arrays. As shown in Figure 3, switched-beam arrays comprise a number of predefined beams. The control system switches among the beams and selects the beam that

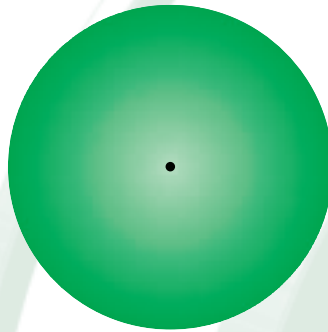

Figure 1 - Omnidirectional antenna

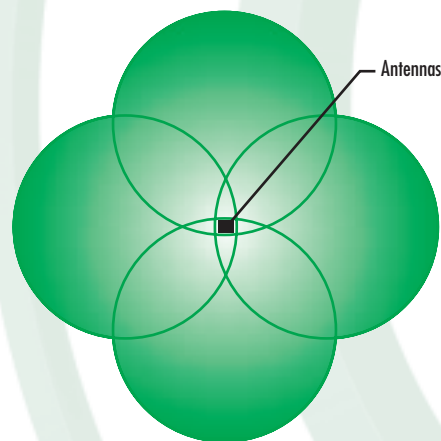

Figure 2 - Sectorized antenna with four sectors

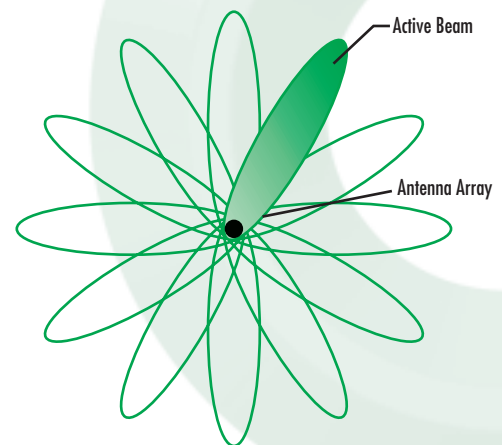

Figure 3 - Switched antenna array with active beam highlighted

provides the maximum signal response.

Adaptive antenna arrays, on the other hand, incorporate more intelligence into their control system than do switched-beam arrays. Adaptive antennas monitor their environment and, in particular, the response of the data path between the user and the base station. This information is then used to adjust the gains of the data received or transmitted from the array to maximize the response for the user. With adaptive antenna arrays, the control system has full flexibility and determines how the gains of the arrays are adjusted. By adjusting the gains in this way, the control system can – in addition to maximizing the gain from a particular user – also attenuate the signal from an interfering source, such as from another user or from multipath signals. Therefore, as shown in Figure 4, adaptive arrays maximize the signal-to-interference-plus-noise ratio (SINR) and not just the signal-to-noise ratio (SNR).

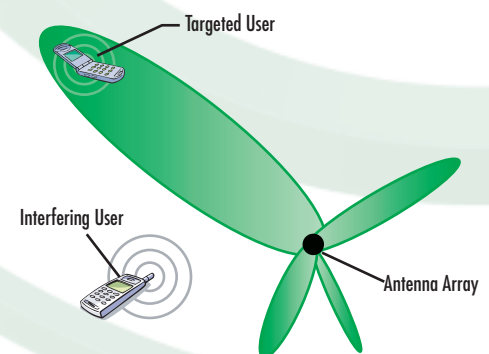

Figure 4 - Adaptive antenna array enhancing the SINR

This dynamic adaptation of the antenna array response provides focused beams to specific users and a new mechanism for multiuser access to the base station. Conventionally, multiple users are separated when accessing the base station by using different frequencies, as in frequency division multiple access (FDMA). FDMA is used in advanced mobile phone services (AMPS) and total access communications systems (TACS). FDMA is also used in

time, as in time division multiple access (TDMA) for global systems for mobile communications, interim standard 136 (IS-136), or code division multiple access (CDMA), which is used in third generation (3G) systems.

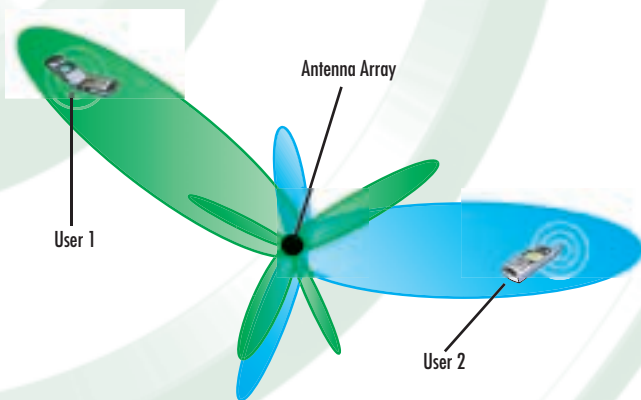

Figure 5 - SDMA allows two users to access the same base station on the same frequency.

As shown in Figure 5, by using smart antenna arrays, we can now use space division multiple access (SDMA). In this case, users may use the same frequency, time, or code allocations over the air interface and only be separated spatially. This enables SDMA to be a complementary scheme to FDMA, TDMA, and CDMA, and SDMA thus provides increased capacity within congested areas.

### Smart Antenna Processing

A fully adaptive antenna array implementation requires a considerable increase in pro-

cessing requirements. Previously, we had a single stream of data coming from a single antenna; now, we have multiple data streams to process. As shown in Figure 6, the data flow diagram for a beam-forming application is not a single input data stream. We now have  $N$  data streams that must be processed from the  $N$  antenna elements.

The fundamental operation carried out in adaptive arrays is to pass the data stream from each antenna through an adaptive finite impulse response (FIR) filter. Note that in narrowband applications, the adaptive FIR filters simplify to a single weight vector. The processing requirements increase, however, with each beam processed.

If we consider a simple example where we have four antennas and a narrowband system, such that the adaptive filters result in a single multiplication, we can see that the processing requirements approach one-half billion multiple accumulates (MACs)

per second, for a sample rate of 105 mega samples per second. This sample rate is for a single beam and does not include the processing requirements for the adaptive update algorithm. This amount of processing does not seem unreasonable for performance in a DSP processor. However, if we want to support multiple beams and achieve finer beams by increasing the number of antennas, we could quickly exhaust the processing capability of a standard processor architecture as we reach processing requirements of several billion MACs per second.

By using FPGAs, we have powerful DSP devices for handling these high-performance requirements at sampled data rates. Furthermore, we can take advantage of the FPGA flexibility for directly handling acquisition control and other DSP functions, such as digital down-conversion, demodulation, and matched filtering.

### 20-Channel Data Acquisition

Figure 7 shows the Nallatech BenADIC™ data acquisition card, which can simultaneously capture data from 20 sources at a sustained rate of 105 mega samples per second. The analog inputs have a 250 MHz bandwidth and the data is digitized at 14 bits resolution. The card produces 3.675 gigabytes of digitized data every second, or the equivalent of 5.4 audio CDs, for processing.

The large number of tightly coupled input channels makes the BenADIC card ideal for processing smart antenna arrays. As shown in Figure 8, the 20 input channels are partitioned into five groups of four channels. The analog-to-digital converters (ADC) in each of these groups are connected to their own Xilinx Virtex™-E FPGAs. This enables local processing of the four channels. Thus, the architecture can be

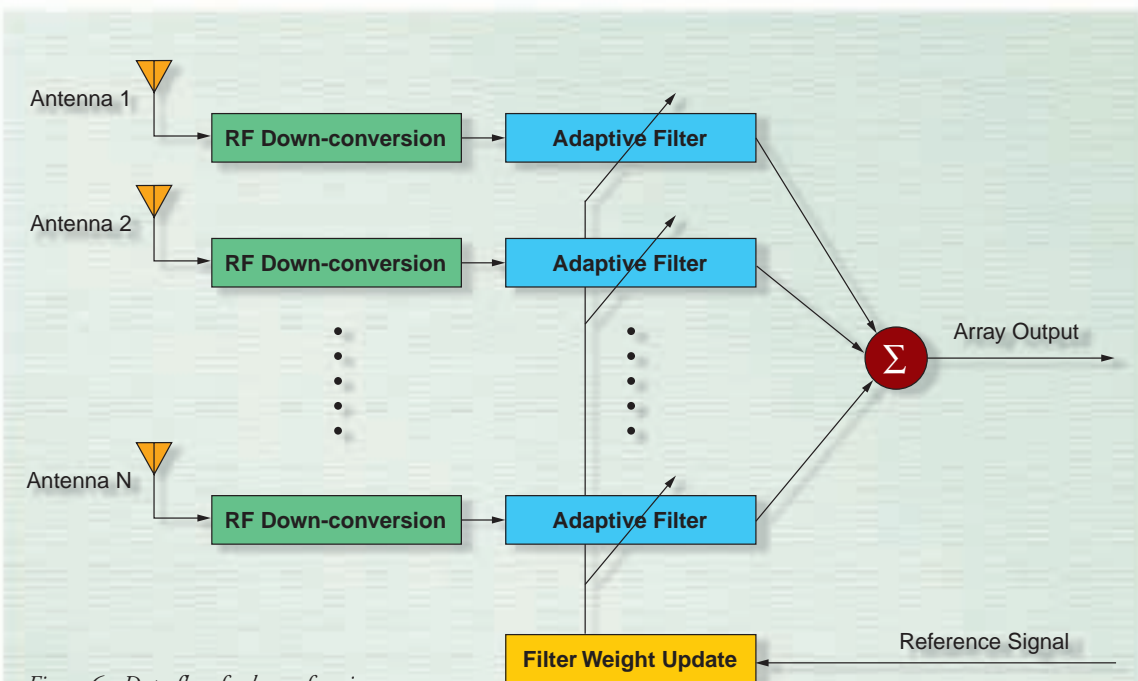

Figure 6 - Data flow for beam-forming





Figure 7 - Xilinx Virtex-E FPGAs on a BenADIC 20-channel, 14-bit data acquisition card

arranged to handle five antenna arrays, each with four antennas within the array. Alternatively, the high-speed internal buses enable these groups to be interconnected to handle an array of 20 antennas.

In addition to the channel group FPGAs, a large FPGA can handle further processing and communicate with the compact PCI (cPCI) backplane and the PCI bus (via the interface FPGA). Communications over the cPCI backplane allow data transfer to other cards in the system, such as to the Nallatech DIME-II™-based BenADIC card, which can accept DIME-II modules and provide more than 50 million system gates with the Virtex-II family for Xilinx XtremeDSP™ operations.

The BenADIC card is compatible with the tools and cores produced by the Xilinx DSP group and includes the powerful System Generator tool. By using System Generator, you can develop and verify your algorithms within MATLAB™ and Simulink™ environments. You can then synthesize and implement your design for the FPGA. This implementation exercise has been carried out successfully for the BenADIC using System Generator.

### Xilinx FPGAs Allow for Software-Defined Radio

The great thing about Xilinx FPGAs is their ability to be reprogrammed on the fly and to give hardware different personalities based on the application. Nallatech has been implementing dynamically reconfigurable FPGA systems for a number of years. The BenADIC card is Nallatech's newest product.

The BenADIC card is compatible with the Nallatech FUSE software environment, which provides the capability to selectively and dynamically change the operation of FPGAs in the BenADIC card or other FPGA-based systems, including modular DIME systems. This ability to dynamically update a system leads to the definition of a software-defined radio where the receiver characteristics are controlled via software.

By using the FUSE software, this control can be handled locally over a PCI or remotely via TCP/IP, for example.

### Conclusion

The BenADIC card from Nallatech couples the power of Xilinx FPGAs with a highly integrated 20-channel data acquisition system on a single card. It is ideally suited for handling large, smart antenna arrays or several smaller arrays.

The combination of the FPGA performance and flexibility enables the realization of advanced DSP algorithms, which in turn opens the possibility for deploying advanced wireless interfaces. Deploying advanced wireless interfaces provides users with a better quality of service and gives service providers greater capacity. ❌

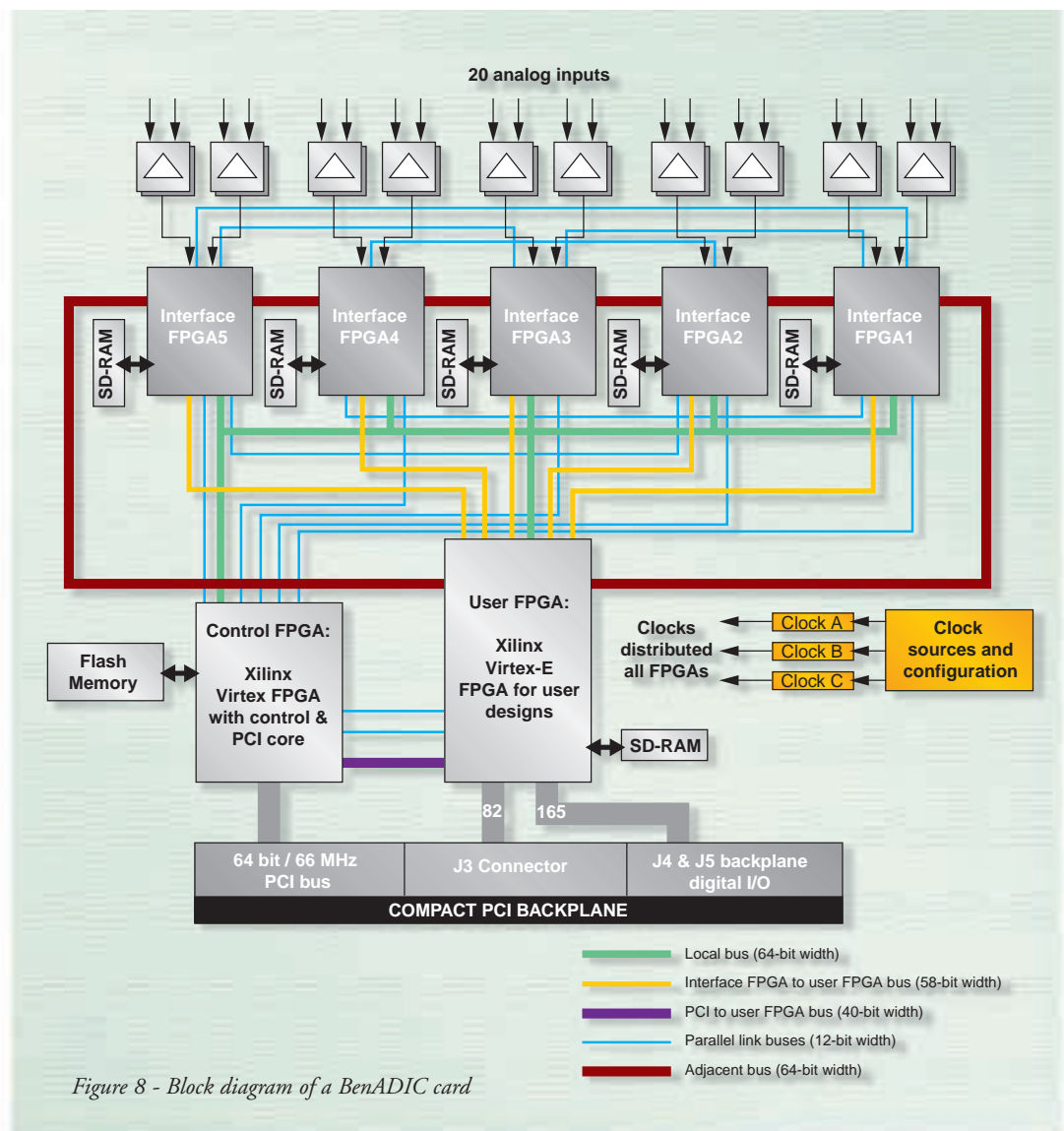

Figure 8 - Block diagram of a BenADIC card