

Opportunities for Service Providers

Rob Wood

AVP, Magellan Broadband Switching
rob.wood@nortel.com



Agenda

- **Market trends**
- Nortel directions
- Service opportunities
- Cost reduction opportunities

The Corporate Revolution

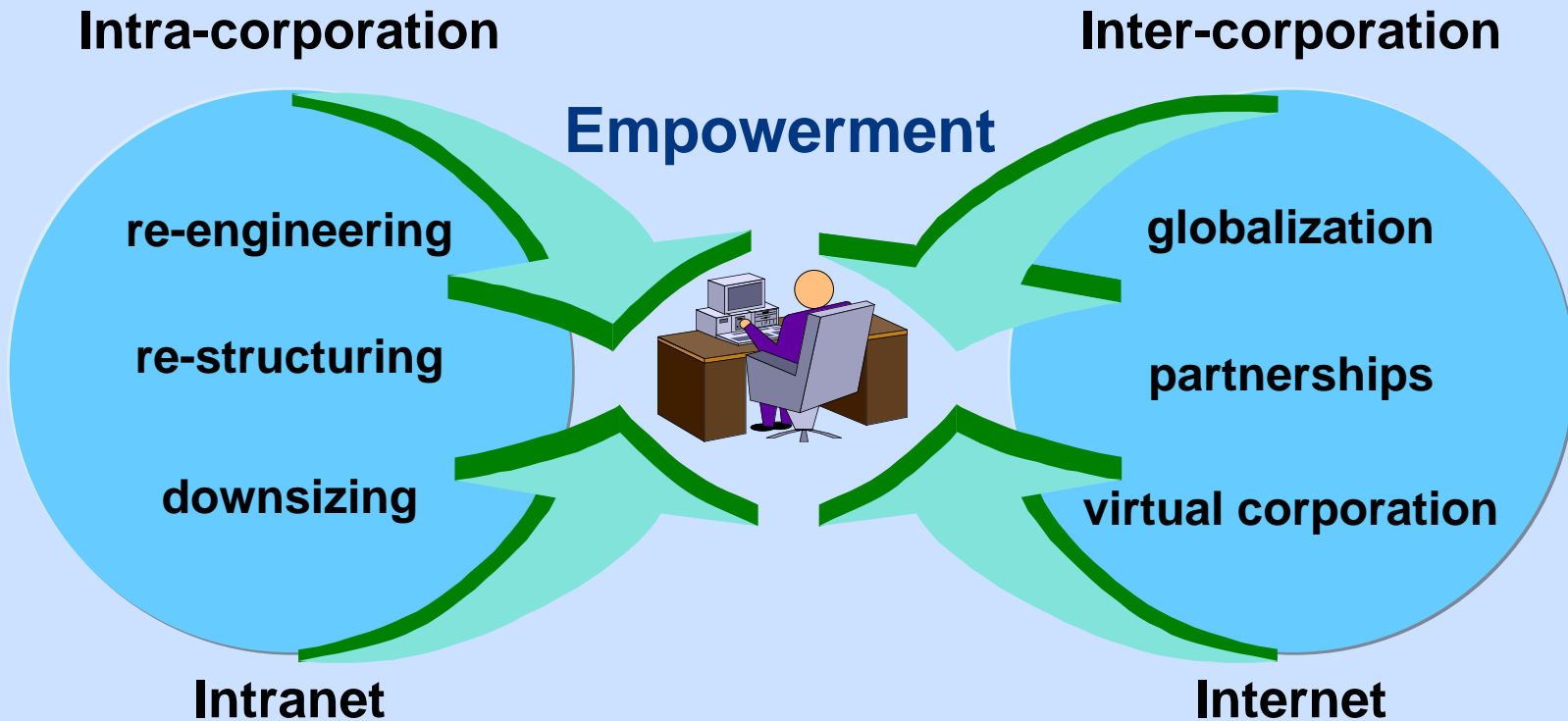

Data communications and the corporate revolution are inseparable

Rapid WAN Service Growth

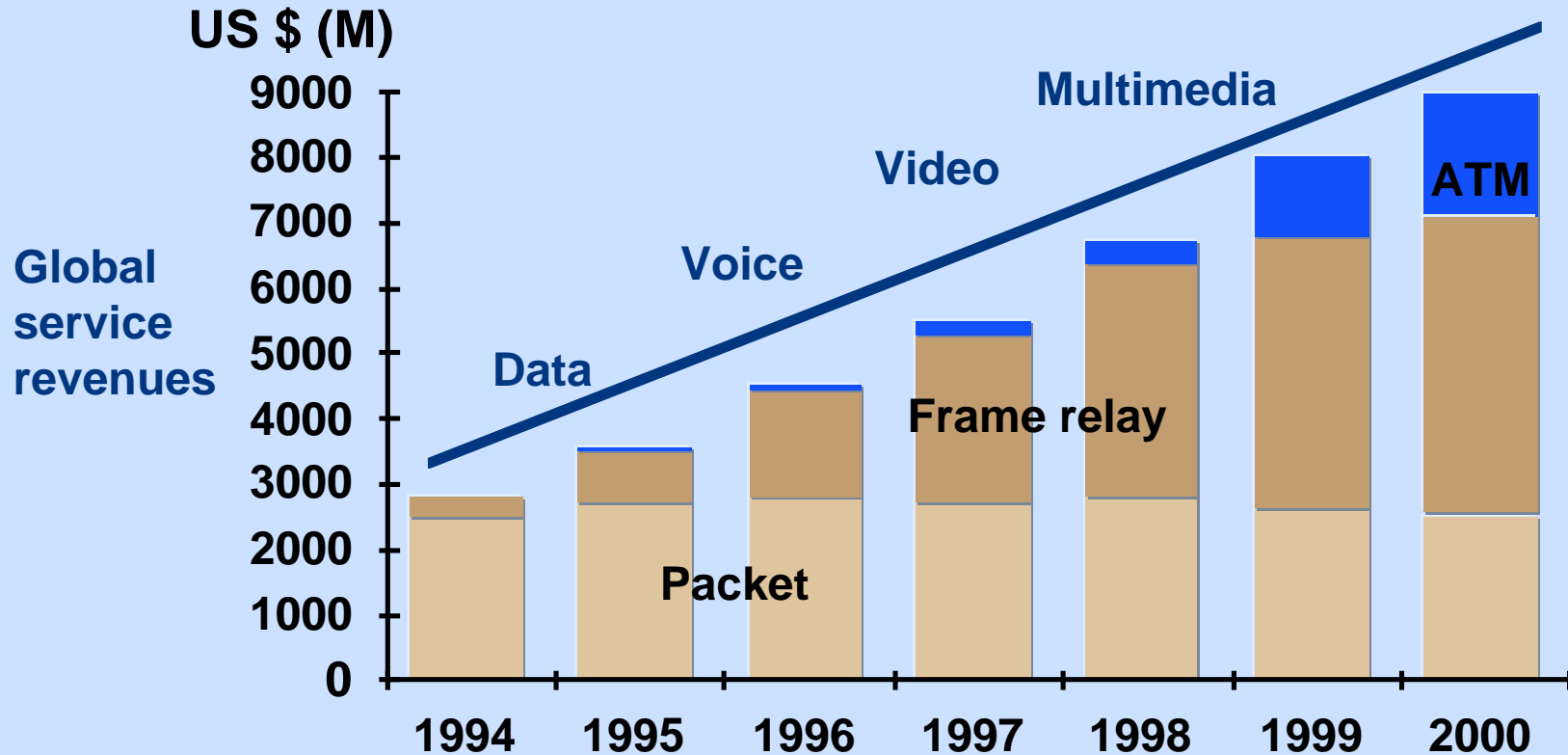

Reference: Vertical System Dec 95 (Frame & ATM) Data Communications Dec 95 (Packet)

Enormous opportunities – and challenges – ahead

The Service Provider's Challenge

- **Rapid delivery of new services**
- **Competitive price/performance**
- **Minimal investment risks**

The Target Network

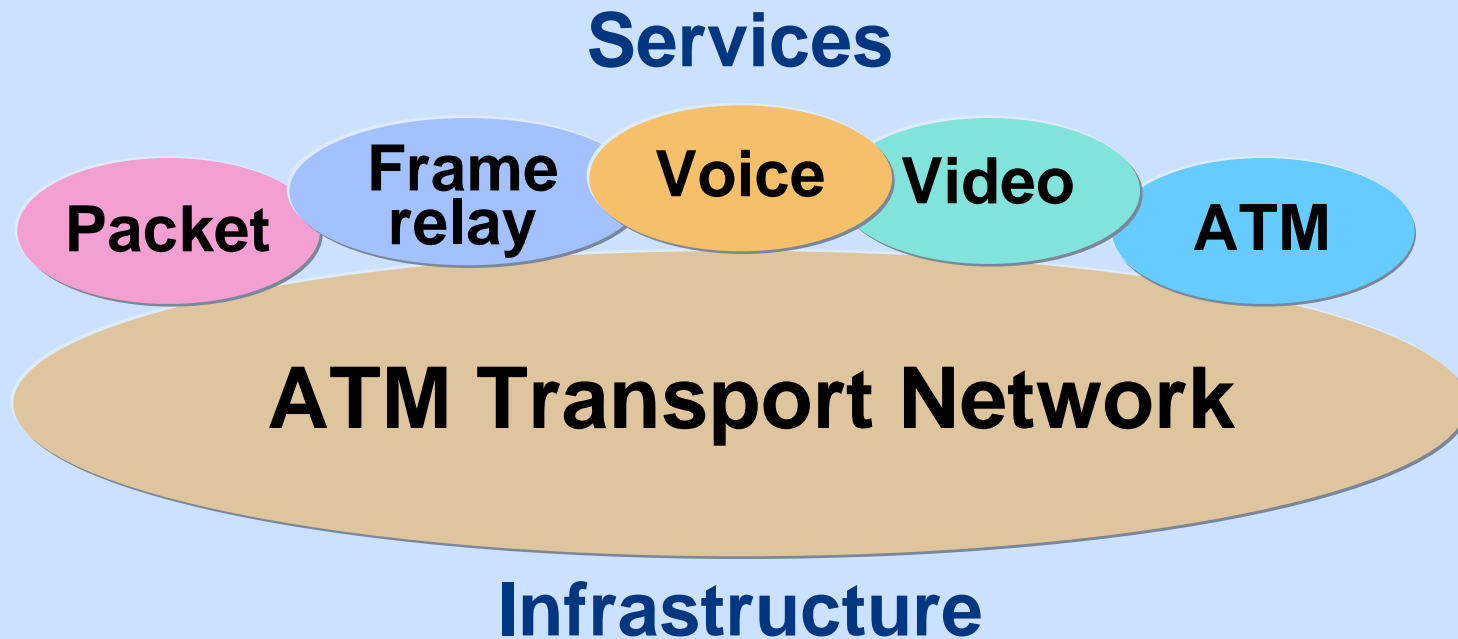

A service-independent infrastructure

Service Network Evolution

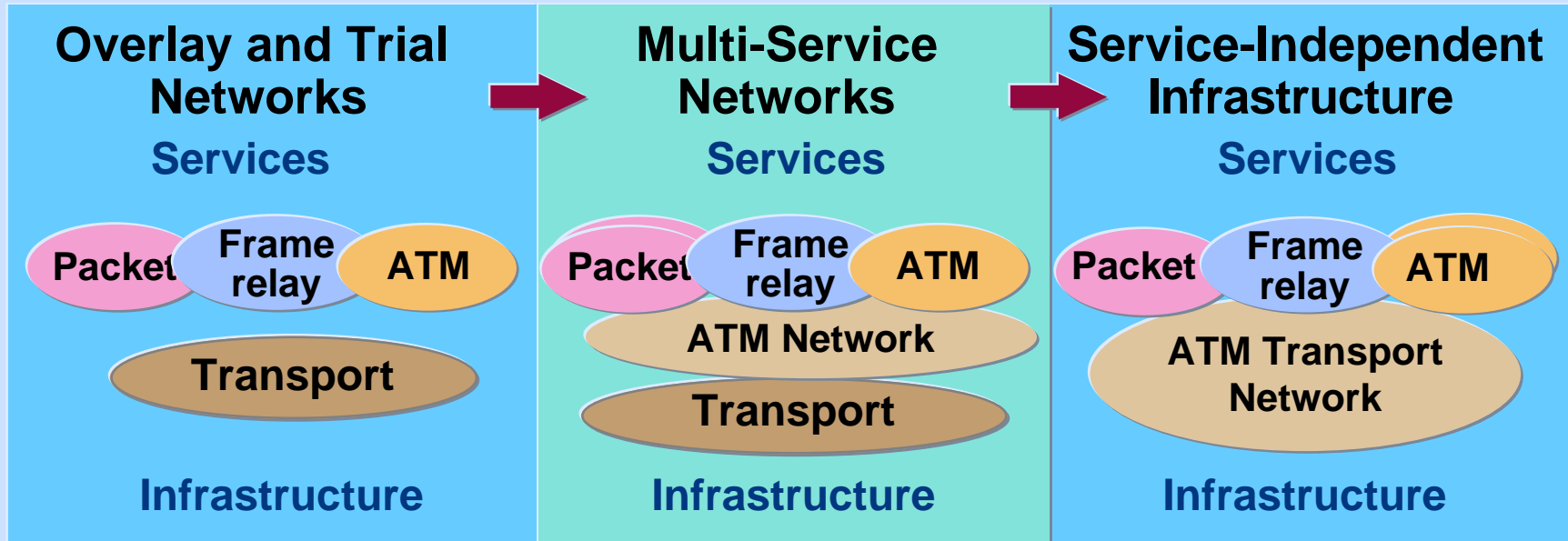

New services introduction
market share focus

Volume deployment
cost reduction focus

Seamless evolution

The Network Architecture

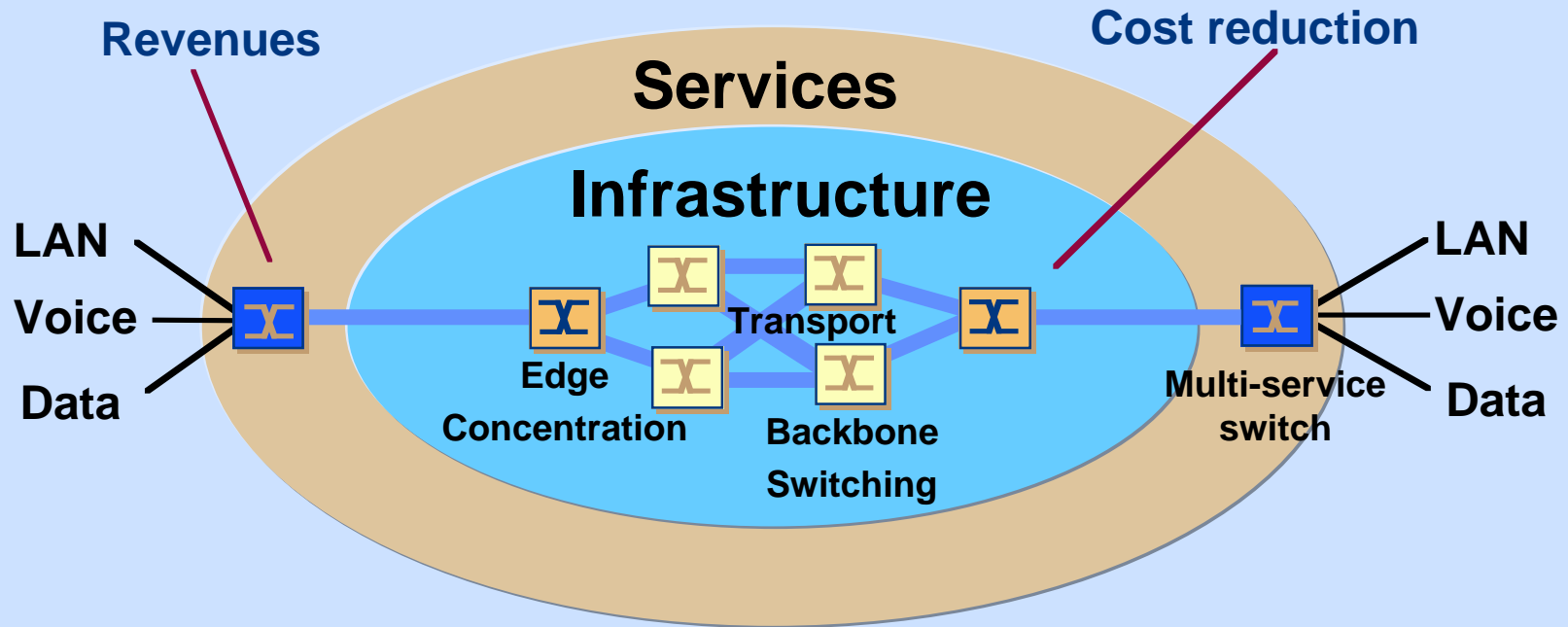

Standard components of the network

Service Migration Challenges

Challenges	Solutions
Packet	Proprietary
Frame Relay	RFC 1483/1490 ITU I.555
LANs	RFC 1483/1577 MPOA, LAN Emulation
Voice	VTOA
Video	MPEG-2

Standards progressing well

Agenda

- Market trends
- **Nortel directions**
- Service opportunities
- Cost reduction opportunities

Nortel's Goals

Increase your revenues by service expansion

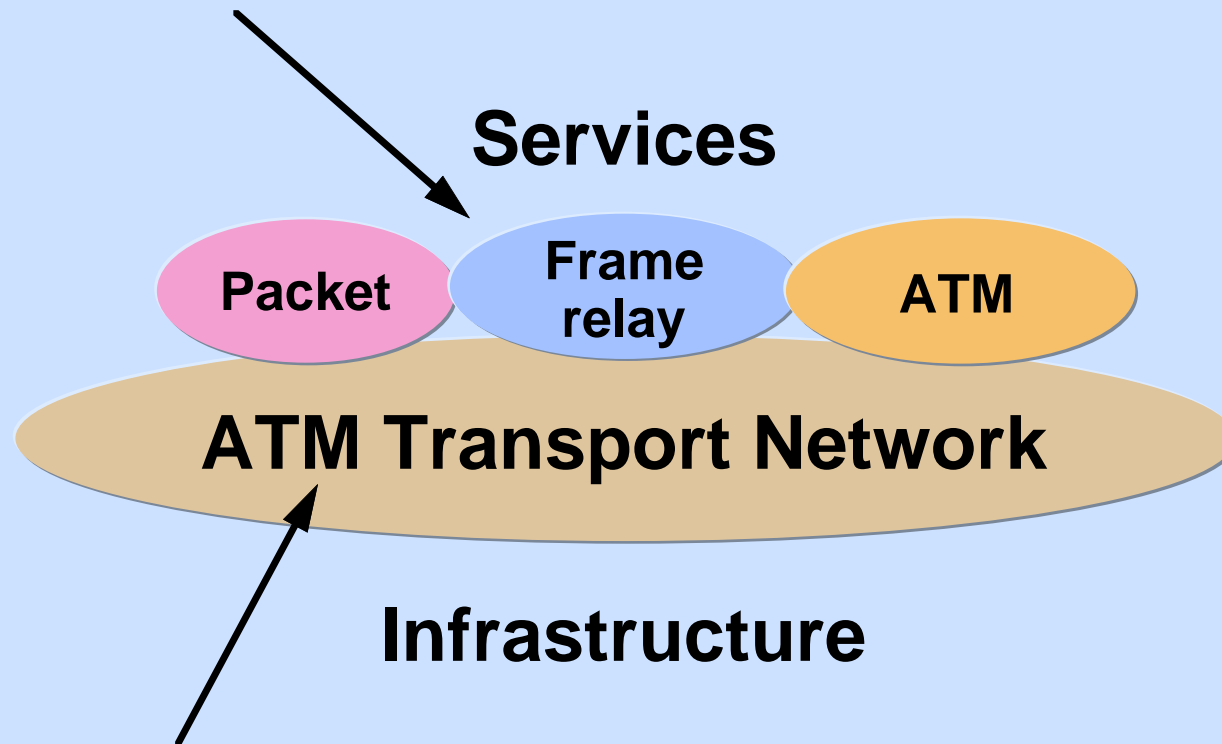

Reduce your costs by network consolidation

Nortel Product Fit

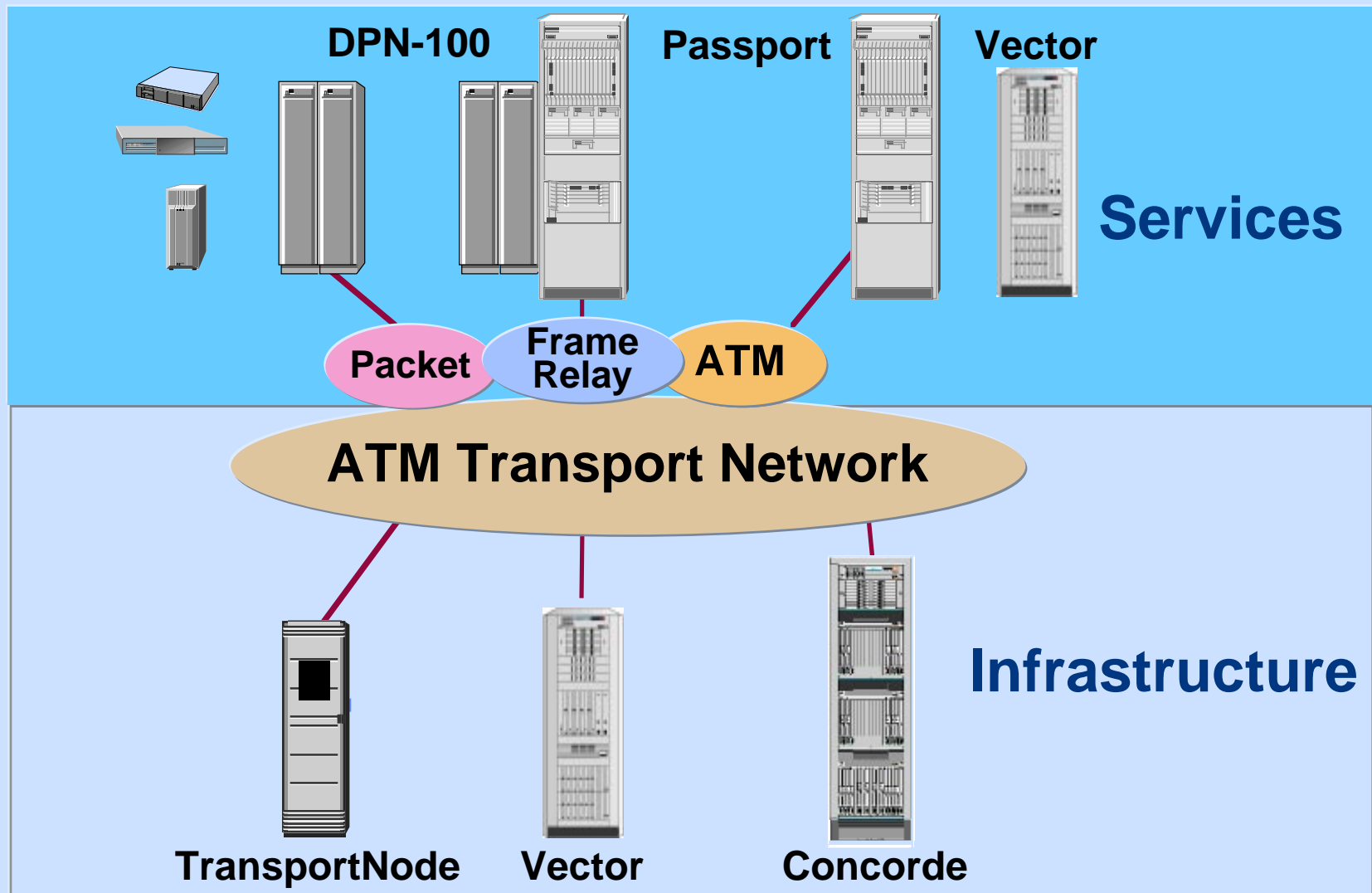

Nortel Magellan Products

**First in
Class**

Packet

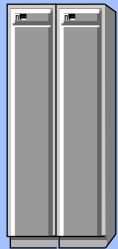

- First public packet network
- First 99.998% availability
- First ISDN packet handler
- First token ring host PAD
- First SNA dial-out

DPN-100

ATM Edge



- First ATM SVCs
- First early packet discard
- First smart buffers
- First soft PVCs
- First LAN CPE integration

Vector

Frame/ATM



- First ATM voice
- First FR SVCs
- First multimedia traffic class
- First FR DS3 access
- First FR realtime disaster recovery
- First FR egress accounting

Passport

ATM Backbone



- First ATM/SONET integration
- First distributed network architecture

Concorde

Technology firsts - your competitive edge

Expanding Nortel Services

**Time to
Market**

Internet Access



Rapport

Residential Data

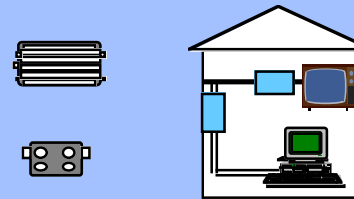

Cornerstone

Circuit Services



TransportNode

MPEG-2 Video

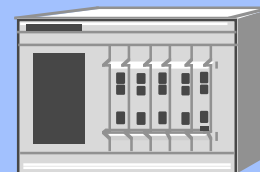

NSAM

New services - your competitive edge

Agenda

- Market trends
- Nortel directions
- **Service opportunities**
- Cost reduction opportunities

“Data” Services



**Revenue
Growth**

**ATM cell relay
Frame relay
X.25
Legacy LAN
SNA**

**Voice
Video
Internet access
ATM LANs
Residential data**

Nortel has a comprehensive data services portfolio

Extending Reach of Packet Services

Revenue Growth

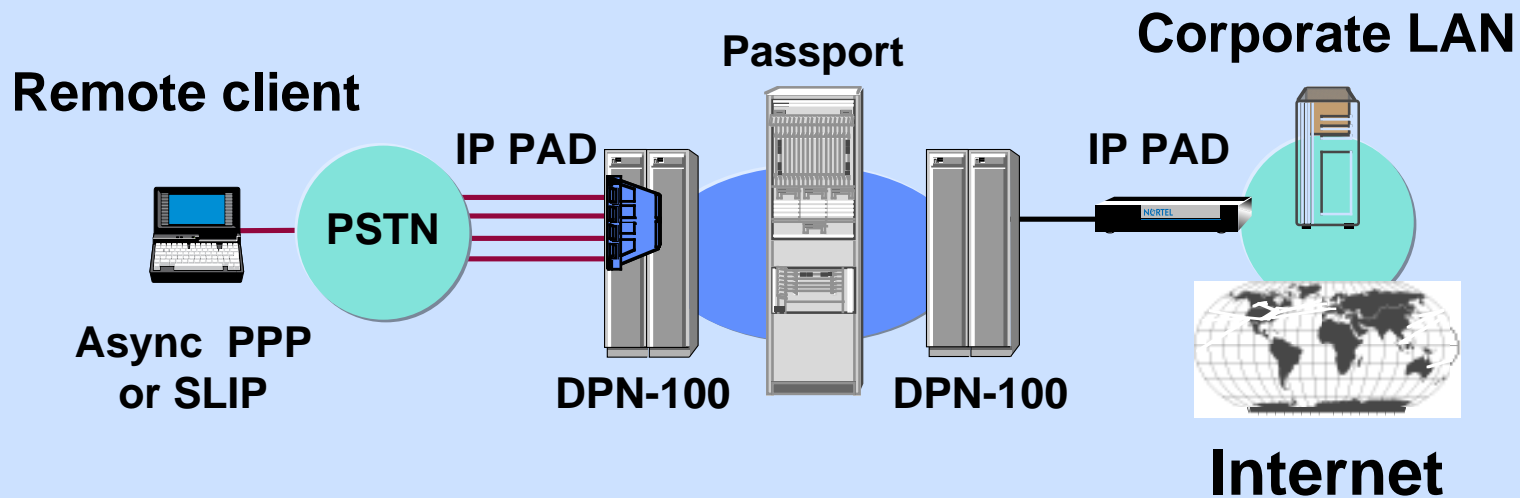

New services, extended reach, and Passport bring more value to the DPN-100 family

Super Frame Relay

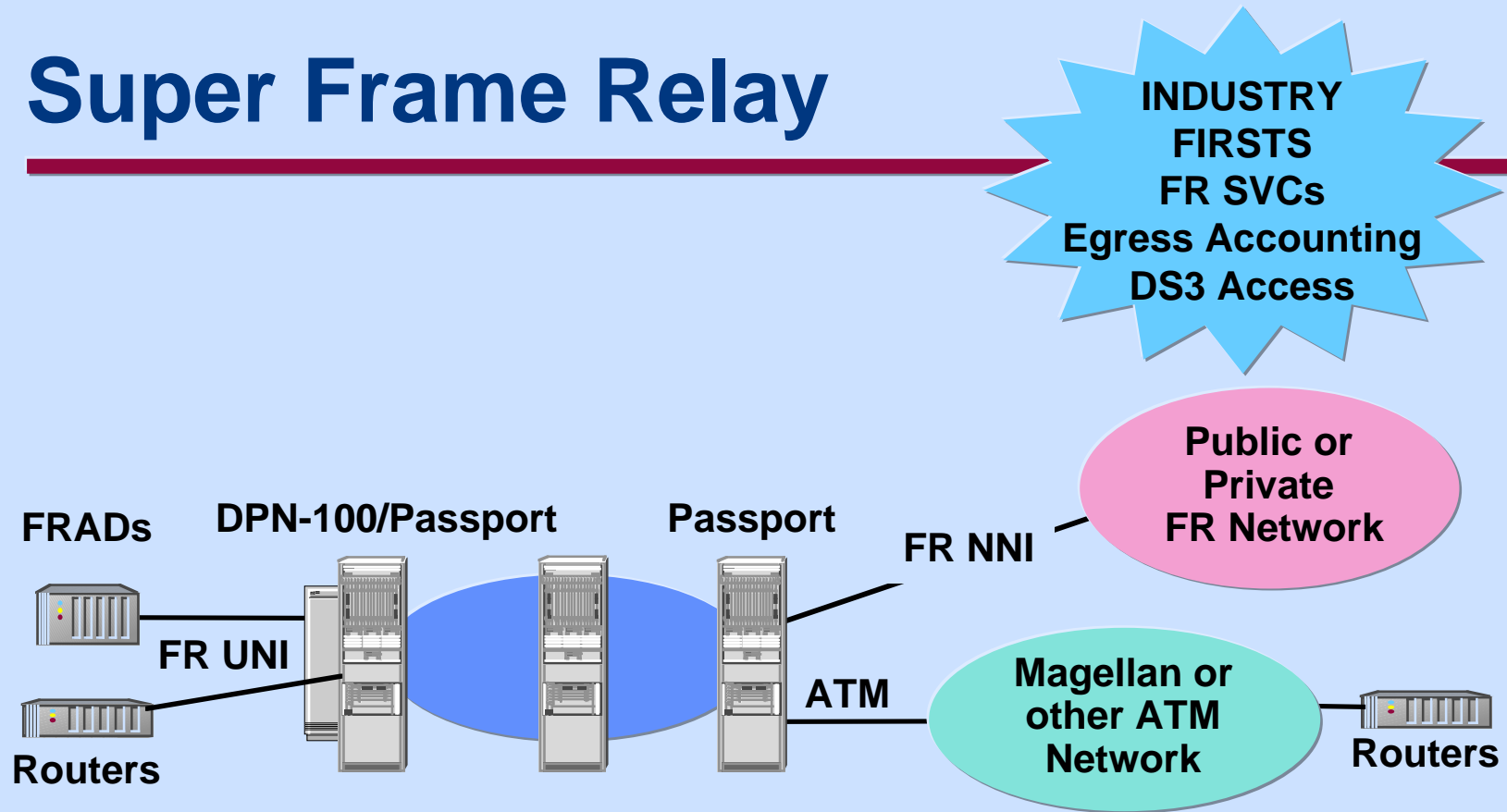

New frame relay applications and cost-effective scalability to meet the demands of rapid growth

Voice VPN Services

INDUSTRY FIRSTS

- Voice/ATM
- Public Service

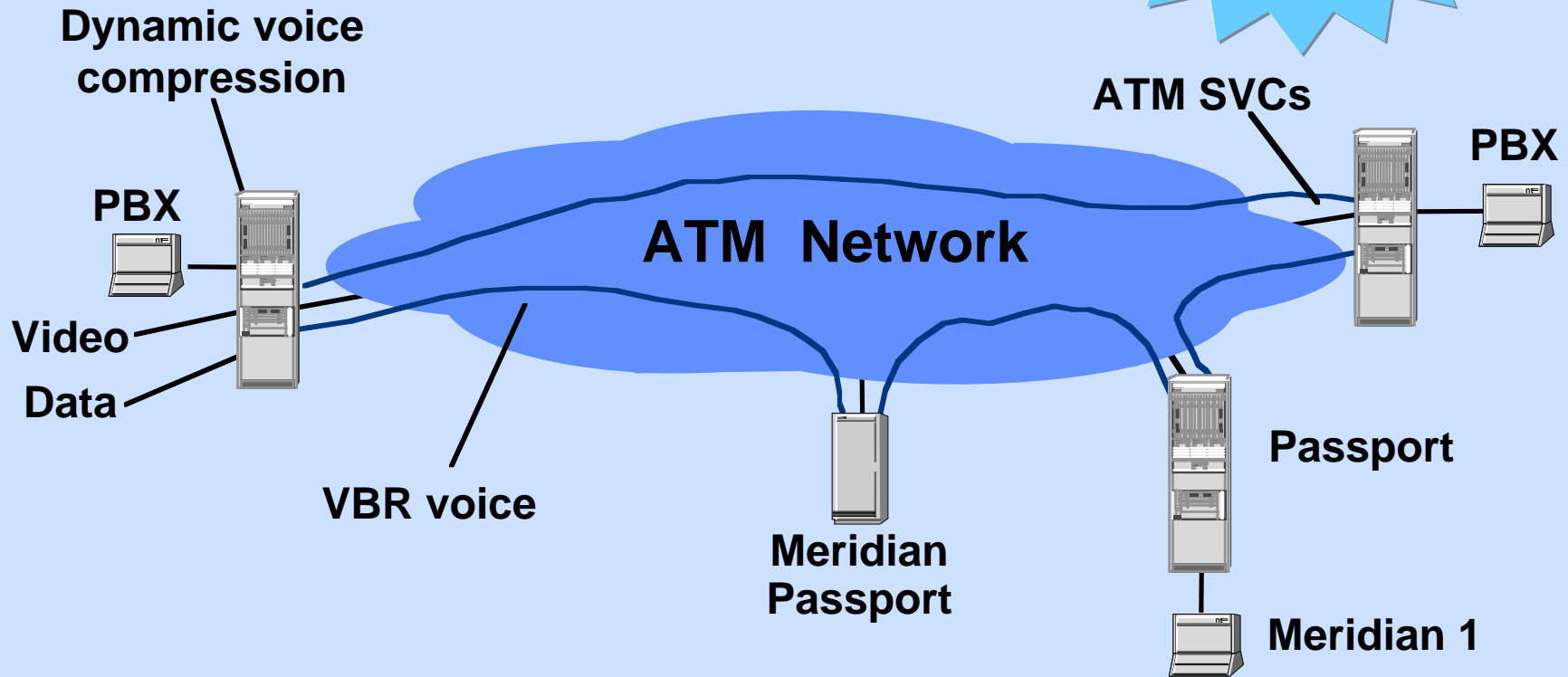

True voice/video/data traffic consolidation

ATM Cell Relay Services

**INDUSTRY
FIRST
ATM SVCs
EPD/PPD**

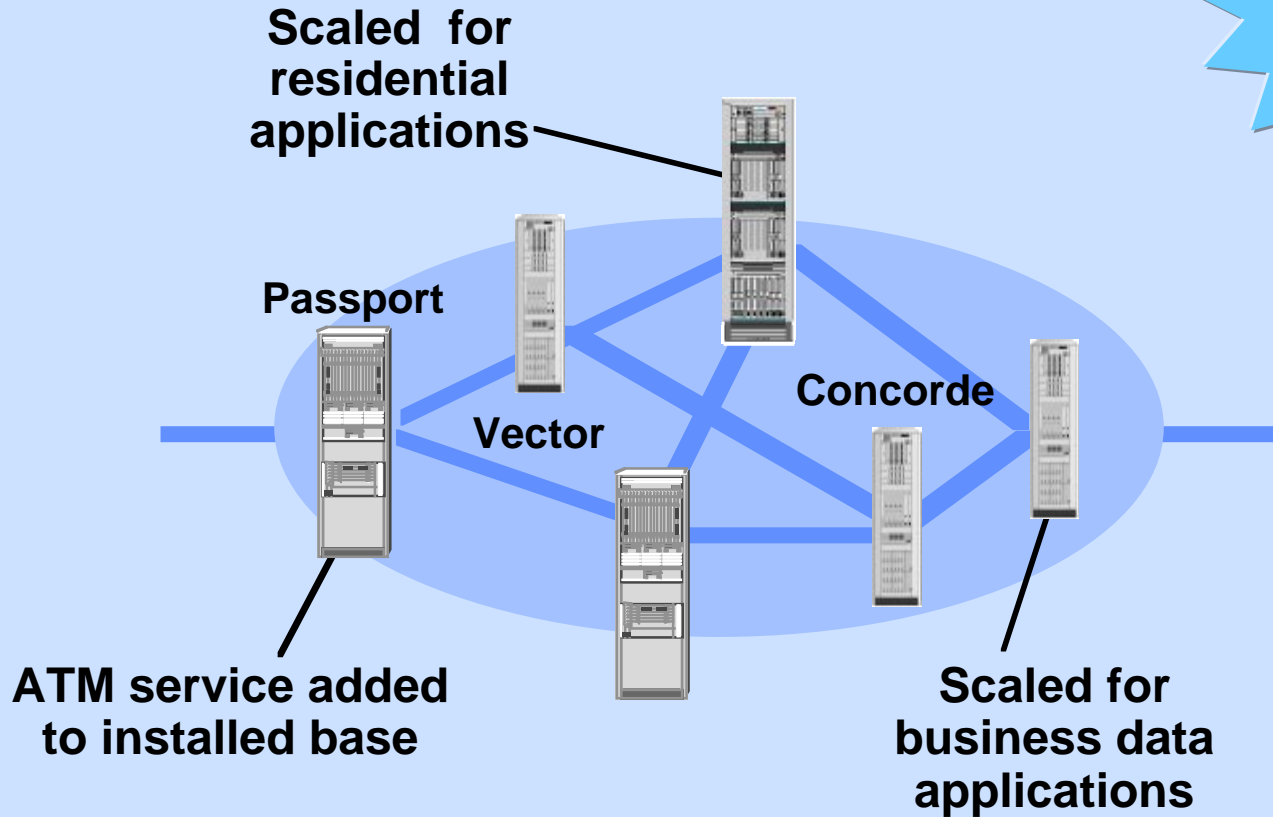

Magellan ATM deployed globally today

LAN Managed Services

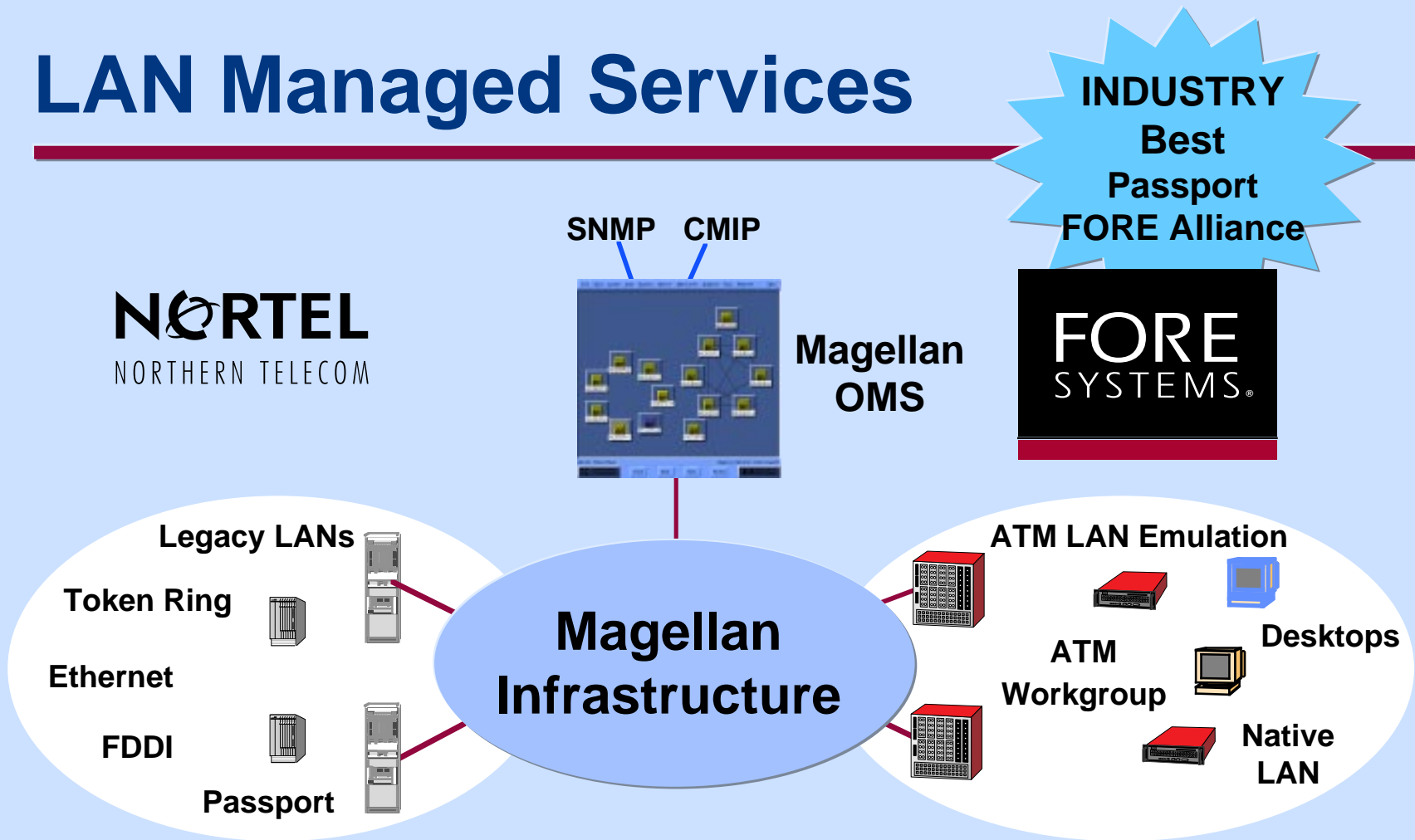

**Seamless end-to-end operations
for LAN-managed services**

Wide Area Video Services

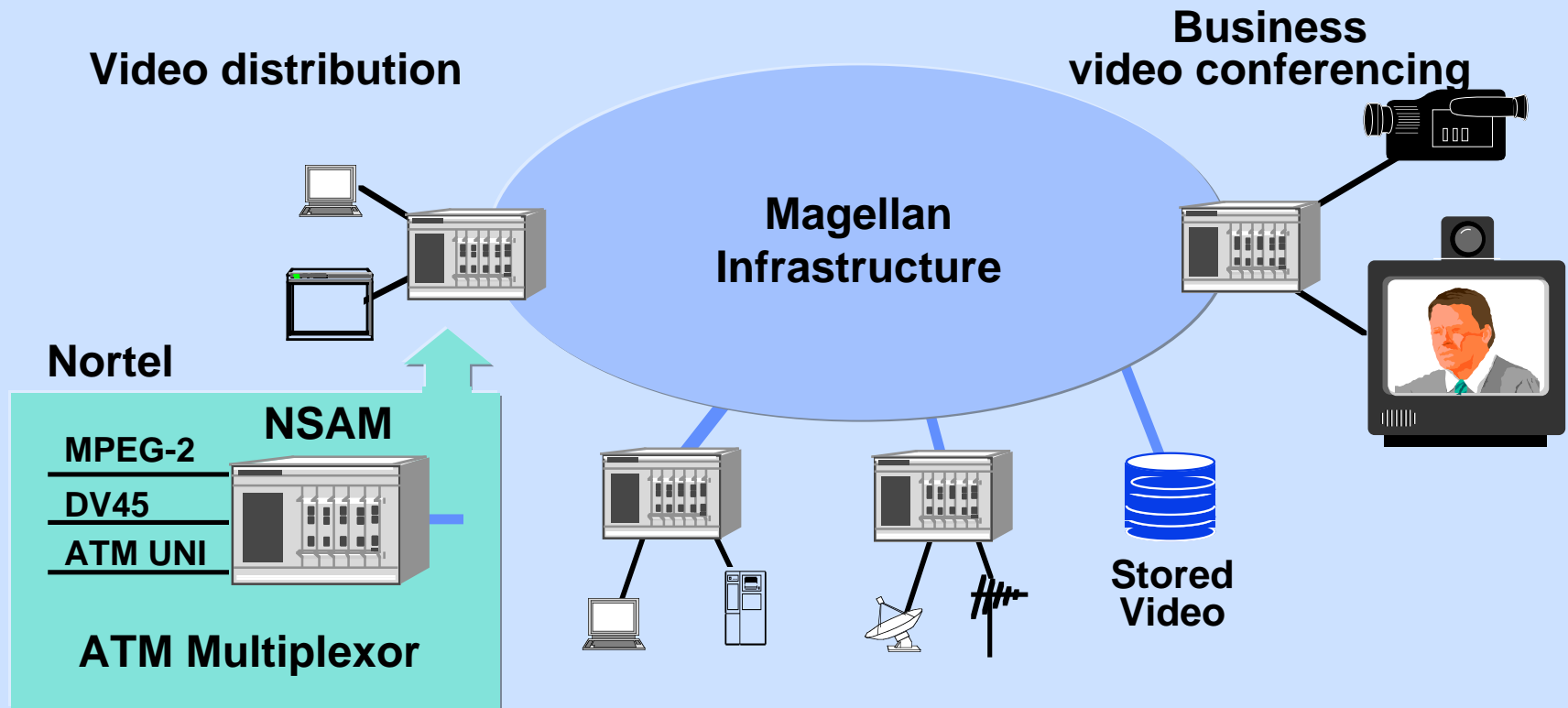

Nortel has solutions for video broadcasting, distribution, and conferencing services

Internet Access

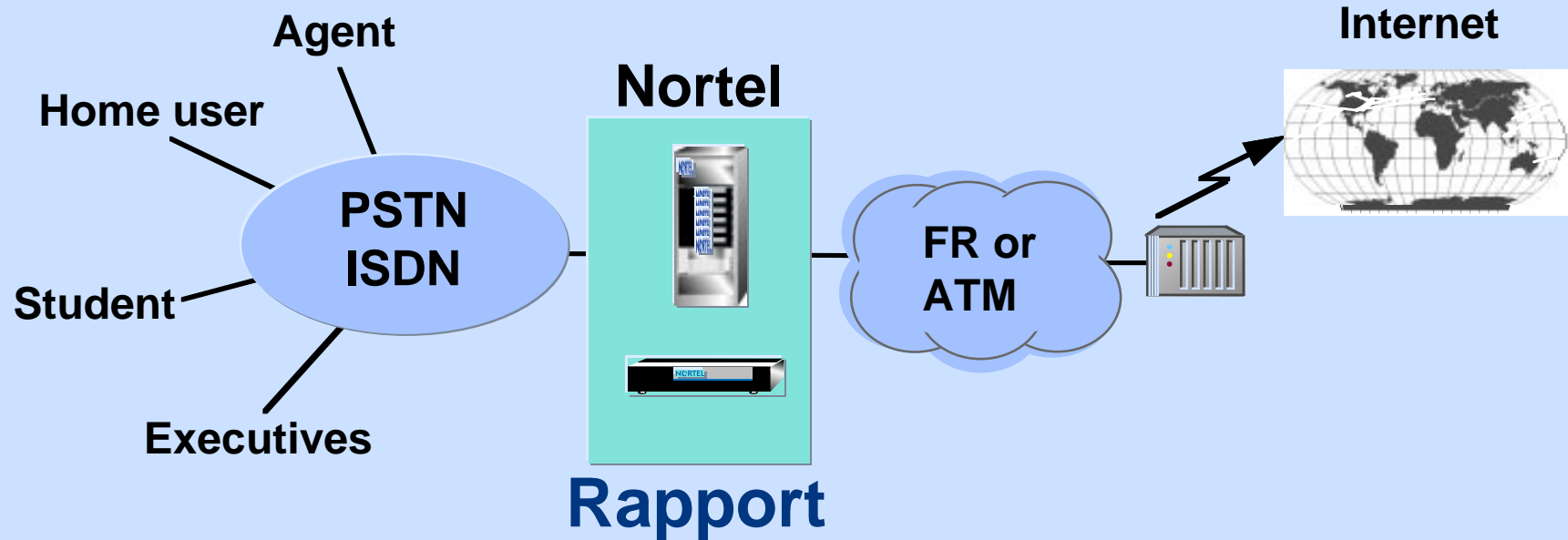

**...access to Internet, making it easier,
more secure and more reliable to use**

Magellan Multimedia Access Vision

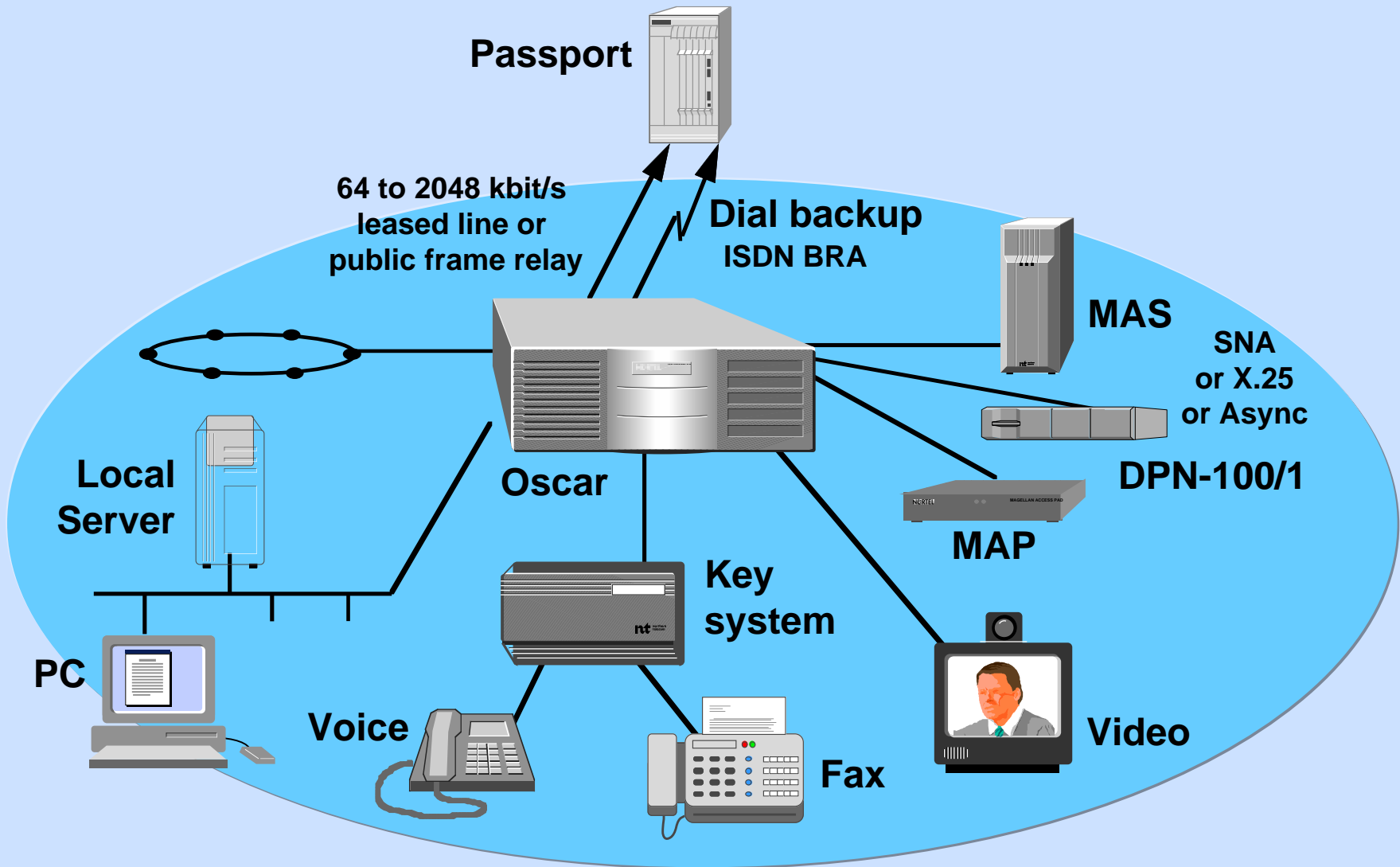

Residential Data Services

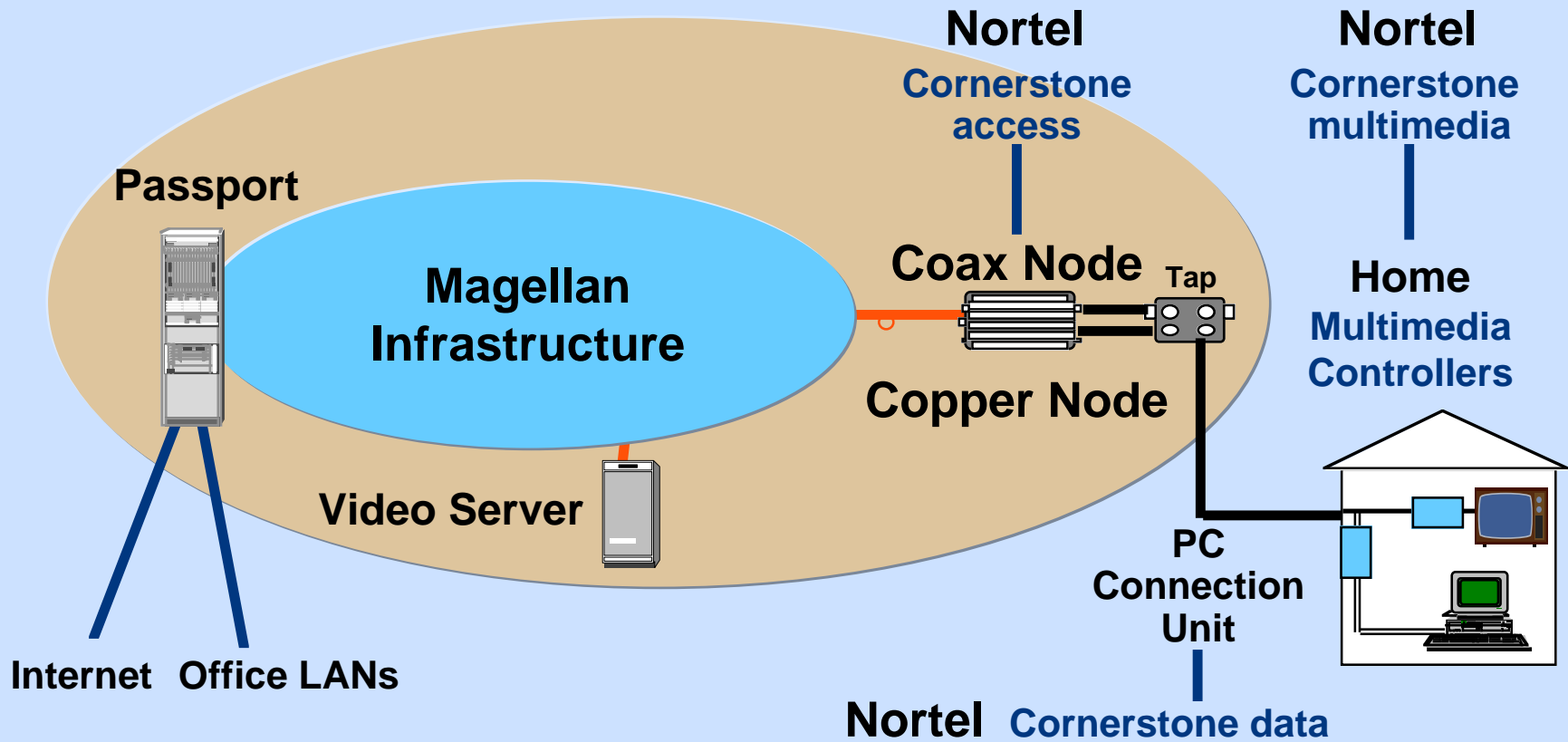

work@home.your living room.at 10 Mbit/s

Data Service Evolution

- Seamless evolution capability unmatched in industry
- Ready migration of Nortel services to new technologies

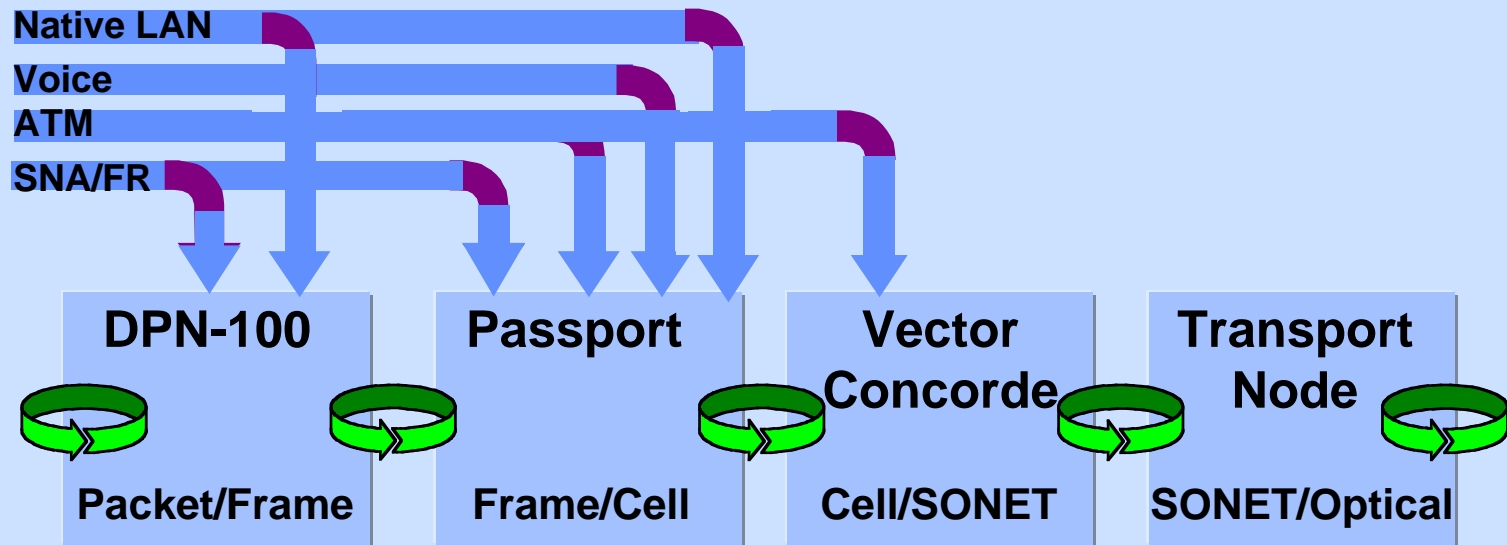

consistent routing, signalling, management

Technology evolution brings new business opportunities with incremental investment and risk

Agenda

- Market trends
- Nortel directions
- Service opportunities
- **Cost reduction opportunities**

Infrastructure Solutions

**Cost
reduction**

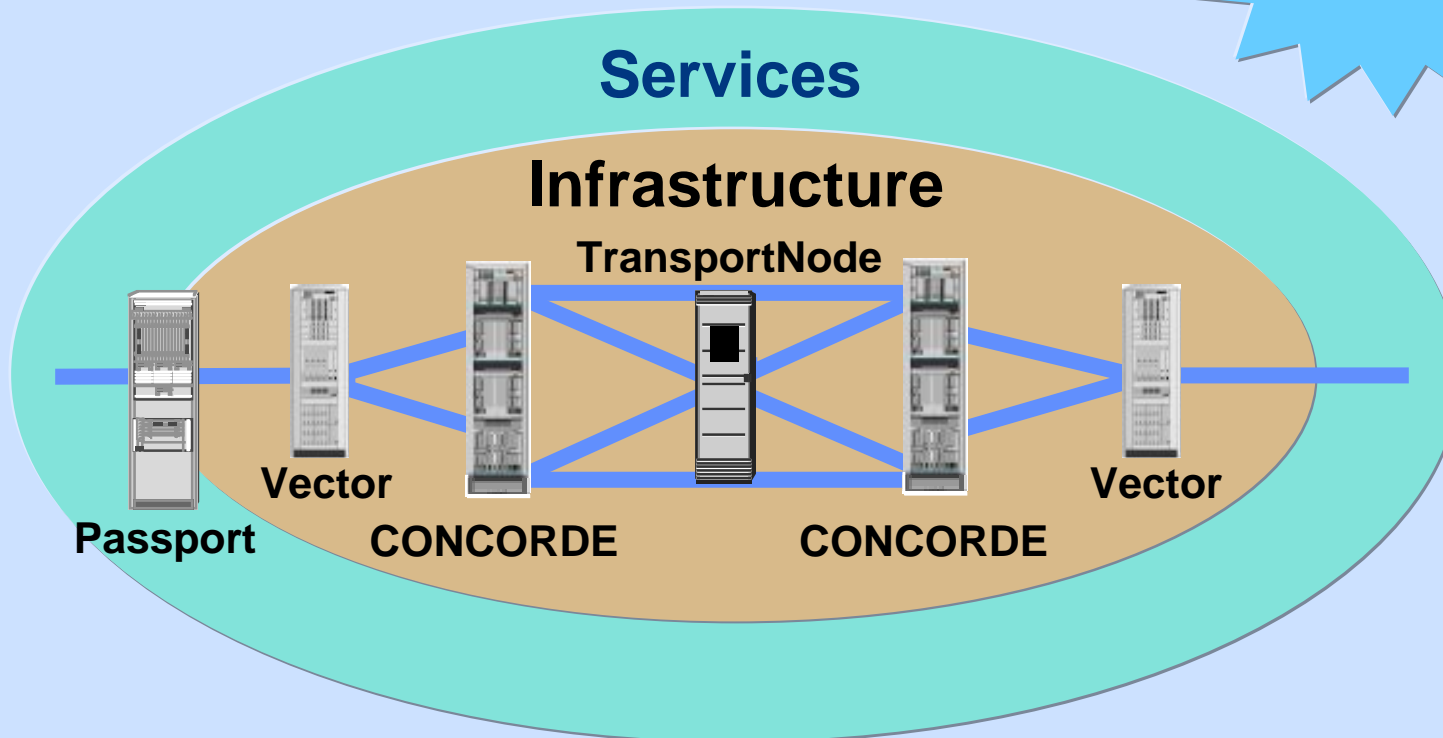

A common infrastructure for multiple services today, with flexibility for future needs

Scalability and Robustness

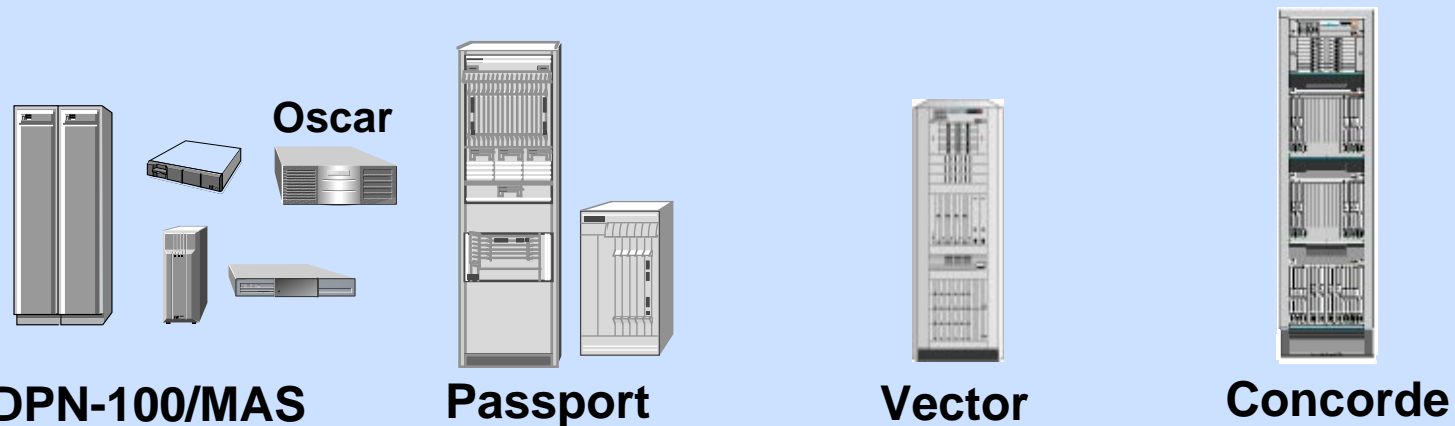

Fully Scalable

- Capacity range up to 80 Gbit/s
- Very high fan-in
- Intelligent buffer management
- Distributed architecture
- Client-server management architecture

Unmatched Robustness

- No single point of failure
- Real time re-routing
- Hot swappable cards
- Billing redundancy
- NEBS and ETSI compliance

- A few ports to hundreds of thousands of ports
- Up to 99.998% availability

Service and Network Management

Applications

- Billing
- Performance data
- Network display and alerts
- End-to-end provisioning
- Service monitor
- VPN/CNM...

Benefits

- ✓ reduces network operating costs
- ✓ provides access via standard i/f
- ✓ uses open platforms
- ✓ integrates Nortel and alliance products
- ✓ is scalable for very large networks
- ✓ provides migration to INA & TMN

NMS MAS DPN-100 Oscar Passport

OMS Oscar Passport Rapport Vector Concorde

Service velocity and reduced costs

ATM/Transport Networks

- Fiber costs reduced - fiber utilization optimized with ATM
- High service availability - full redundancy, SONET and ATM protection
- Management costs reduced - common management system

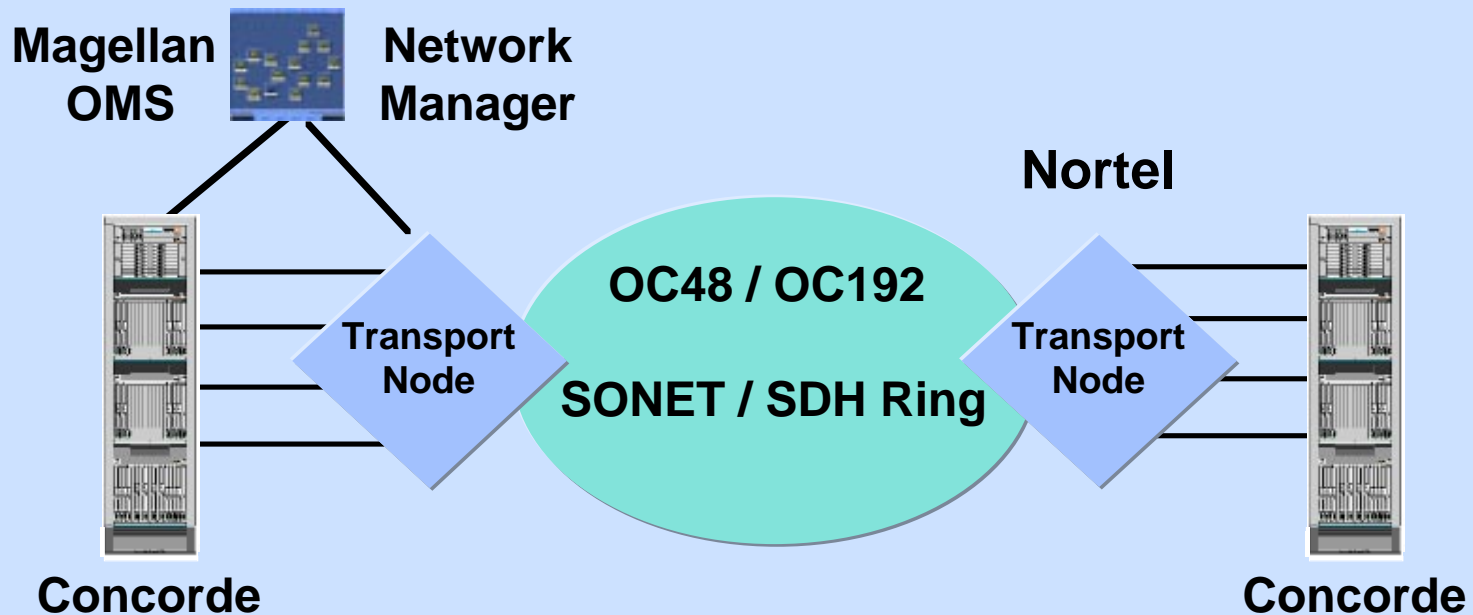

ATM integration with SONET/SDH significantly reduces costs

PSTN Evolution to ATM

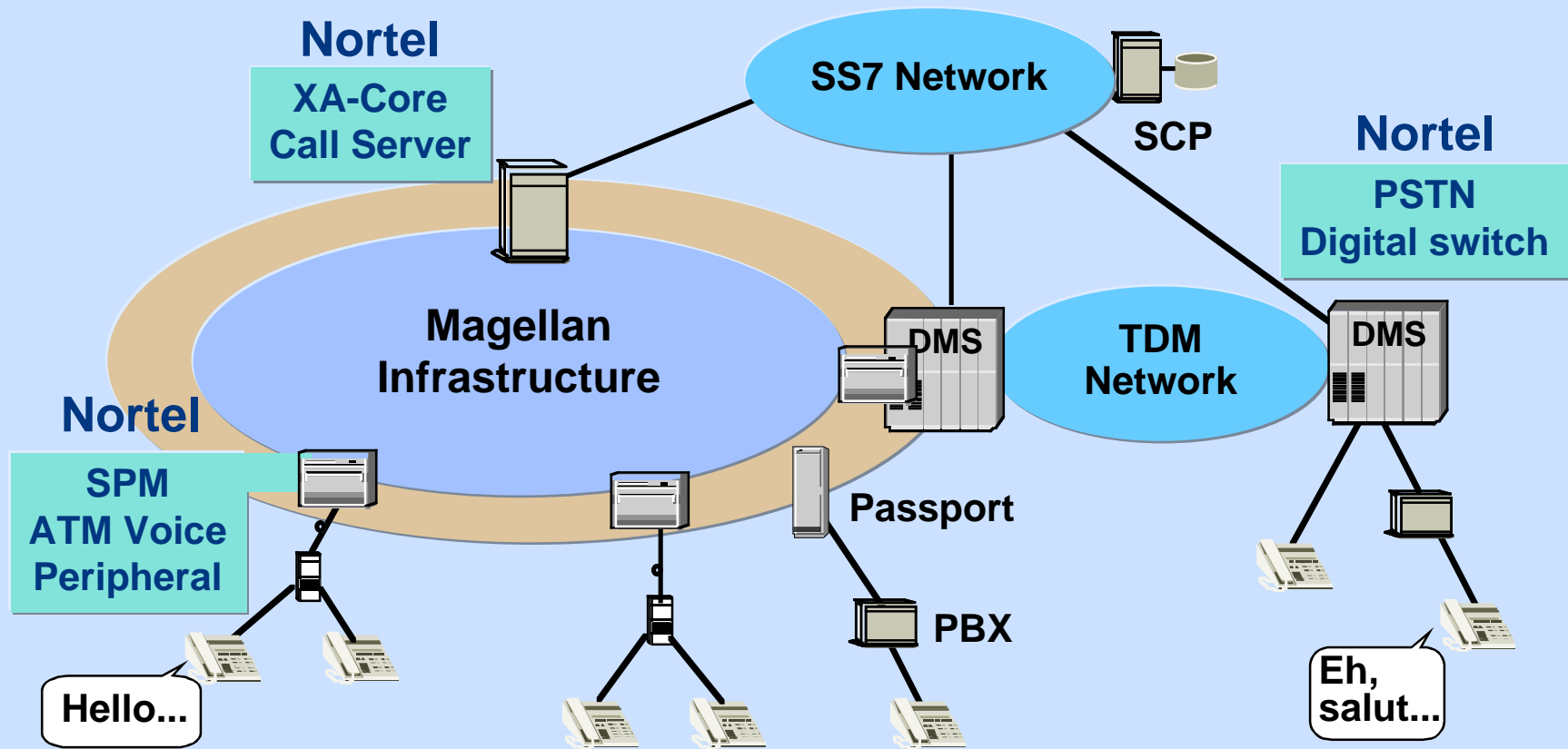

Nortel leadership: the ATM voice switch

Nortel Solutions

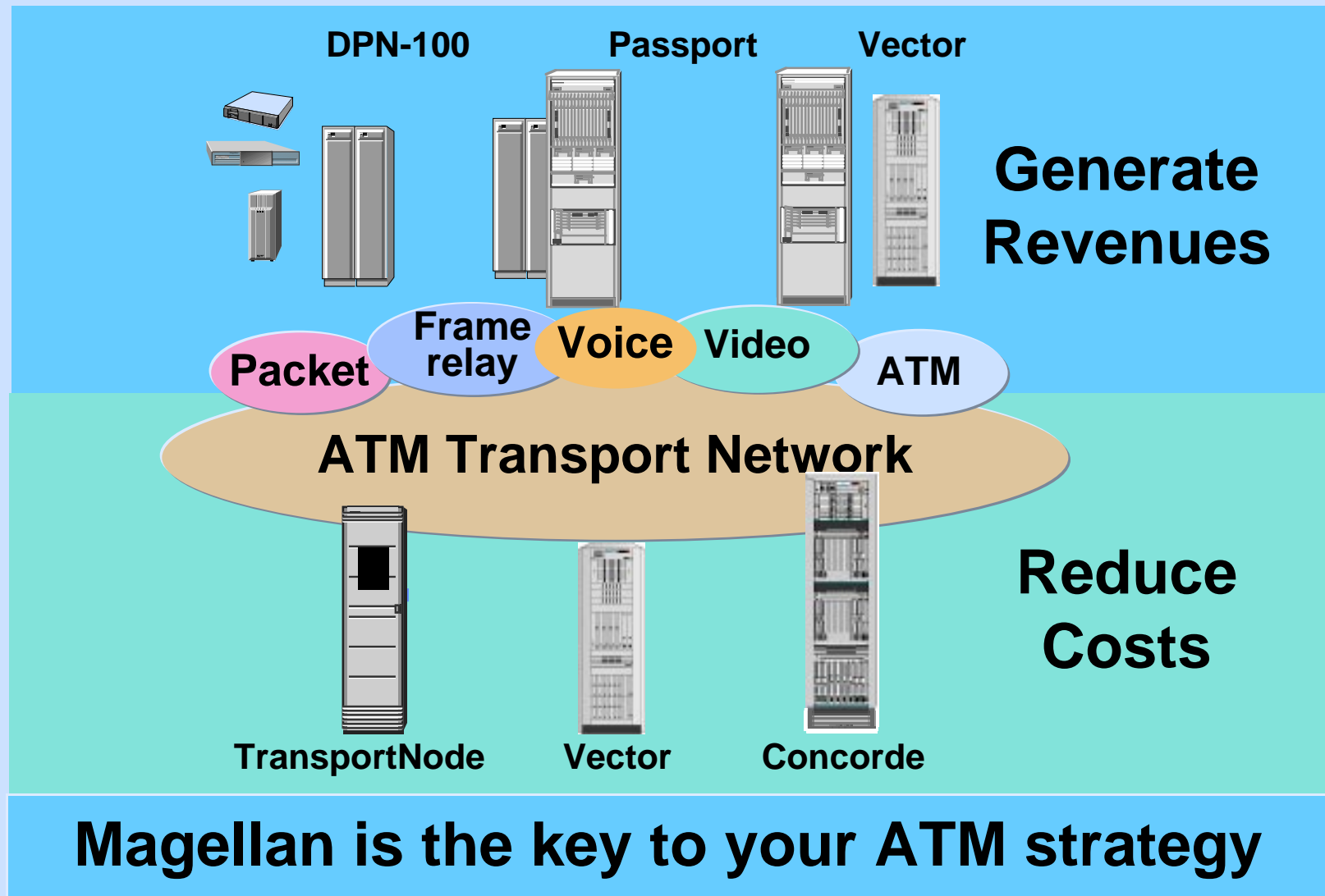

Nortel Commitment

Nortel believes that ATM will be the basis of a ubiquitous broadband multimedia network

Nortel will evolve its data, voice and video products to transition gracefully to the ultimate vision